



Assembly Instructions

Installation set for

FriwaMidi-Kaskade

FriwaMaxi-Kaskade

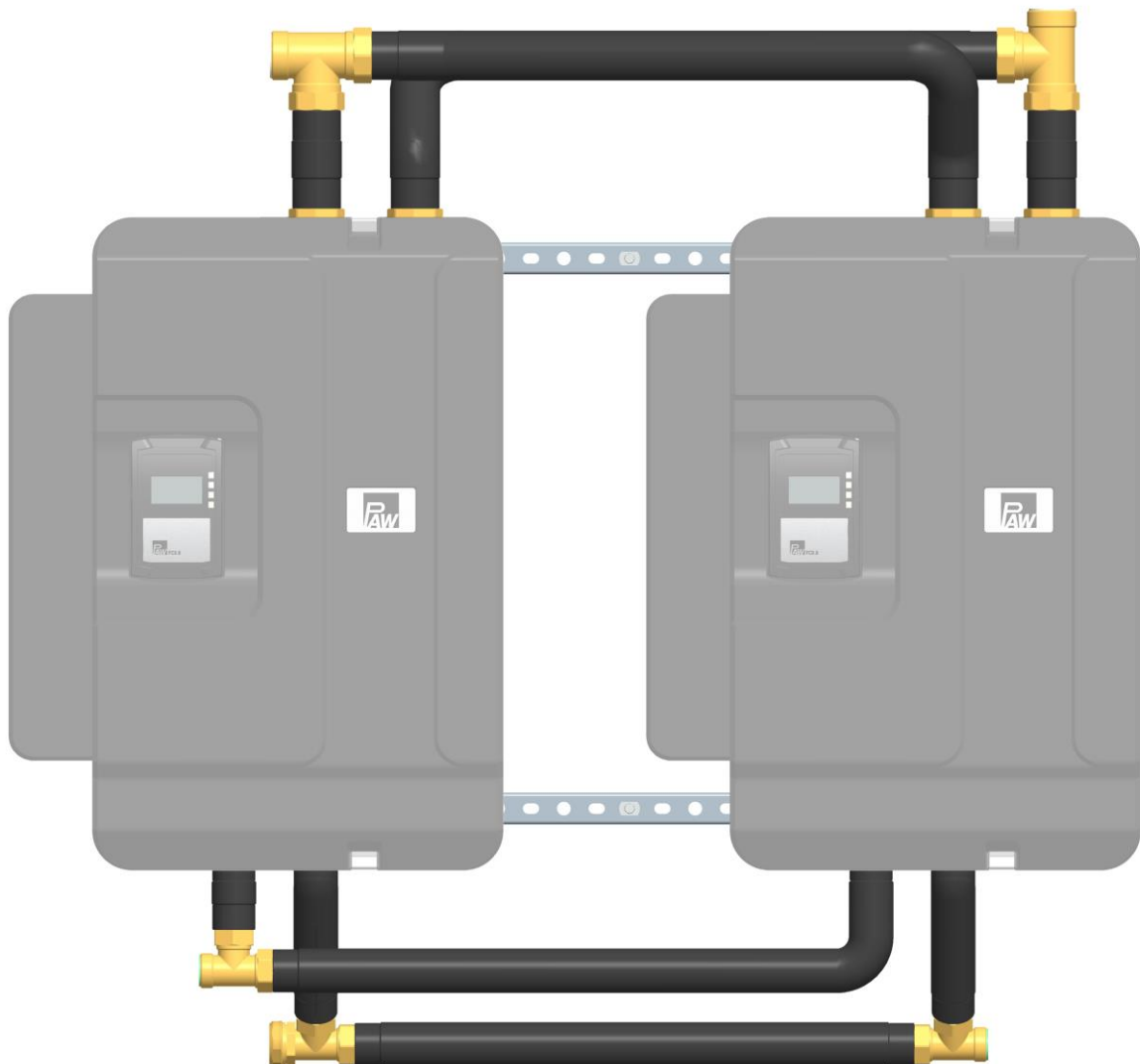

Contents

1	General information	3
1.1	Scope of these instructions	3
1.2	About this product	3
1.3	Designated use	3
2	Safety instructions	4
3	Product description	5
4	Dimensioning and planning	6
5	Assembly and installation [specialist]	7
5.1	Dimensions installation set FriwaMidi-Kaskade	7
5.2	Dimensions installation set FriwaMaxi-Kaskade	7
5.3	Installation and commissioning of the switch valve sets with 2-way electro valves	11
5.4	Controller connection FC4.13.....	15
5.5	Operation of the controller FC4.13	16
5.6	Controller connection FC3.8.....	18
5.7	Operation of the controller FC3.8	19
6	Scope of delivery	20
6.1	Installation set for FriwaMidi 2-fold cascade	20
6.2	Installation set for FriwaMaxi 2-fold cascade	21
7	Technical data 2-way zone valve	22
8	Commissioning report	23

Item no. 99640429x2-mub-en - Version V05 – Date 2015/05

Translation of the original instructions

We reserve the right to make technical changes without notice!

Printed in Germany – Copyright by PAW GmbH & Co. KG

PAW GmbH & Co. KG

Böcklerstraße 11

D-31789 Hameln, Germany



Carefully read these instructions before installation and commissioning.
Save these instructions in the vicinity of the installation for future reference.

1 General information

1.1 Scope of these instructions

These instructions describe the assembly and installation of the installation set for the FriwaMidi-Kaskade and the FriwaMaxi-Kaskade.

The chapters called [specialist] are intended for specialists only.

For other components of the installation, such as the domestic hot water modules, storage tanks, controllers and pumps, please observe the instructions of the corresponding manufacturer.

1.2 About this product

With the installation set, two domestic hot water modules FriwaMidi DN 20 or FriwaMaxi DN 25 can be cascaded.

1.3 Designated use

The installation set may only be used for the installation of a cascade of two domestic hot water modules FriwaMidi or two domestic hot water modules FriwaMaxi.

The technical data specified in these instructions must be observed.

Only use PAW accessories with the installation set.

Improper usage excludes any liability claims.

The wrapping materials are made of recyclable materials and can be disposed of with recyclable materials.

2 Safety instructions

The installation and commissioning as well as the connection of electrical components require technical knowledge commensurate with a recognised vocational qualification as a fitter for plumbing, heating and air conditioning technology, or a profession requiring a comparable level of knowledge [specialist].

The following must be observed during installation and commissioning:

- relevant local and national regulations
- accident prevention regulations of the professional association
- instructions and safety instructions of this manual

NOTICE

Material damage due to mineral oils!

Mineral oil products cause lasting damage to seals made of EPDM, whereby the sealant properties get lost. We do not assume liability nor provide warranty for damage to property resulting from sealants damaged in this way.

- It is imperative to avoid that EPDM gets in contact with substances containing mineral oils.
- Use a lubricant based on silicone or polyalkylene and free of mineral oils, such as Unisilikon L250L and Syntheso Glep 1 of the Klüber company or a silicone spray.

3 Product description

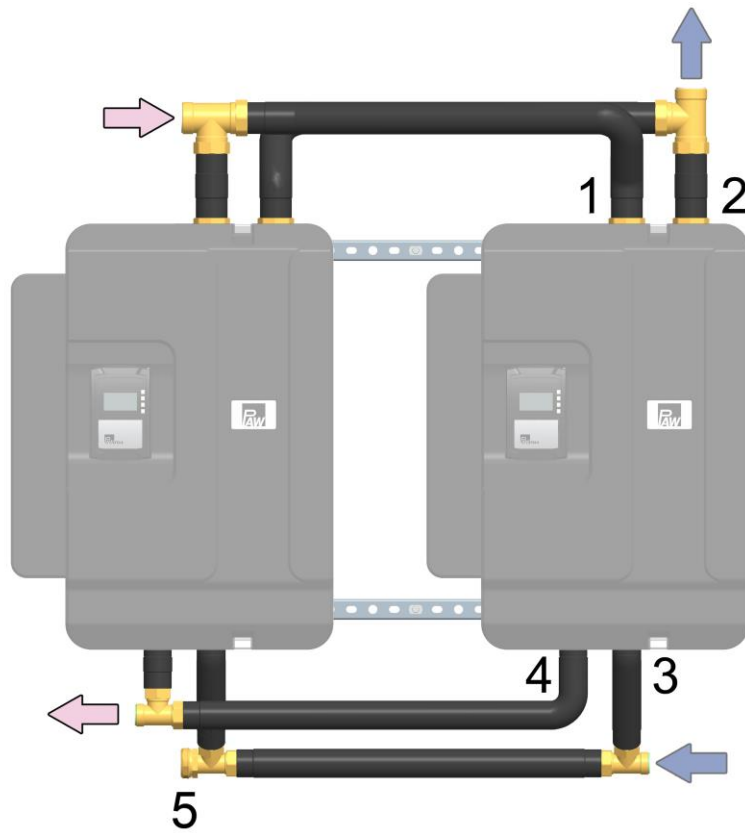



Connections

- 1 Primary side:
Flow from the buffer tank
- 2 Primary side:
Return to the buffer tank
- 3 Secondary side:
Cold water inlet
- 4 Secondary side:
Hot water outlet
- 5 Connection circulation

4 Dimensioning and planning

The FriwaMidi and FriwaMaxi are domestic hot water modules which heat potable water operating on the principle of a flow-type water heater.

The FriwaMidi and FriwaMaxi can only work flawlessly if the installation meets certain requirements. Please take some time to plan the installation.

	 WARNING
	<p>Danger of scalding due to hot water!</p> <p>Undesirable circulation of water in the primary circuit can cause the exit of water of up to 90 °C at the withdrawal point.</p> <ul style="list-style-type: none"> ➤ External pumps must not be installed between the domestic hot water module and the buffer tank. ➤ The domestic hot water module must not be connected to a distribution manifold.

Mounting example: FriwaMaxi-Kaskade

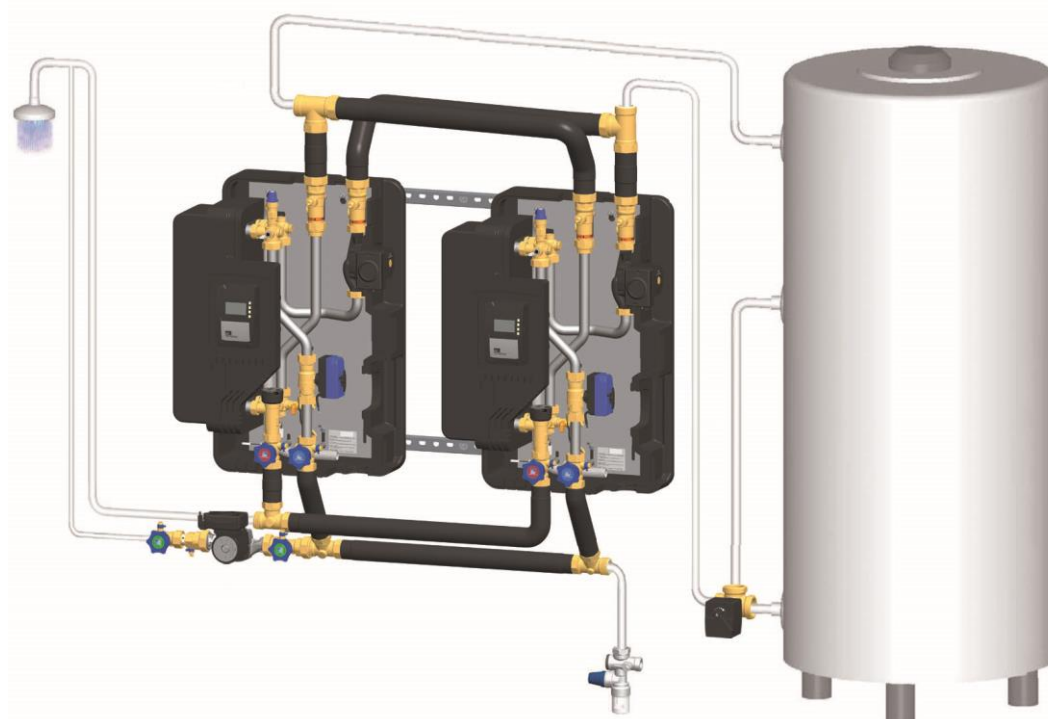

FriwaMaxi-Kaskade with 2 x FriwaMaxi, with installation set and optional circulation set (provided by the customer, item no. 6404136GH7 or 6404136GH10) and return distribution set (provided by the customer, item no. 640424)

5 Assembly and installation [specialist]

5.1 Dimensions installation set FriwaMidi-Kaskade

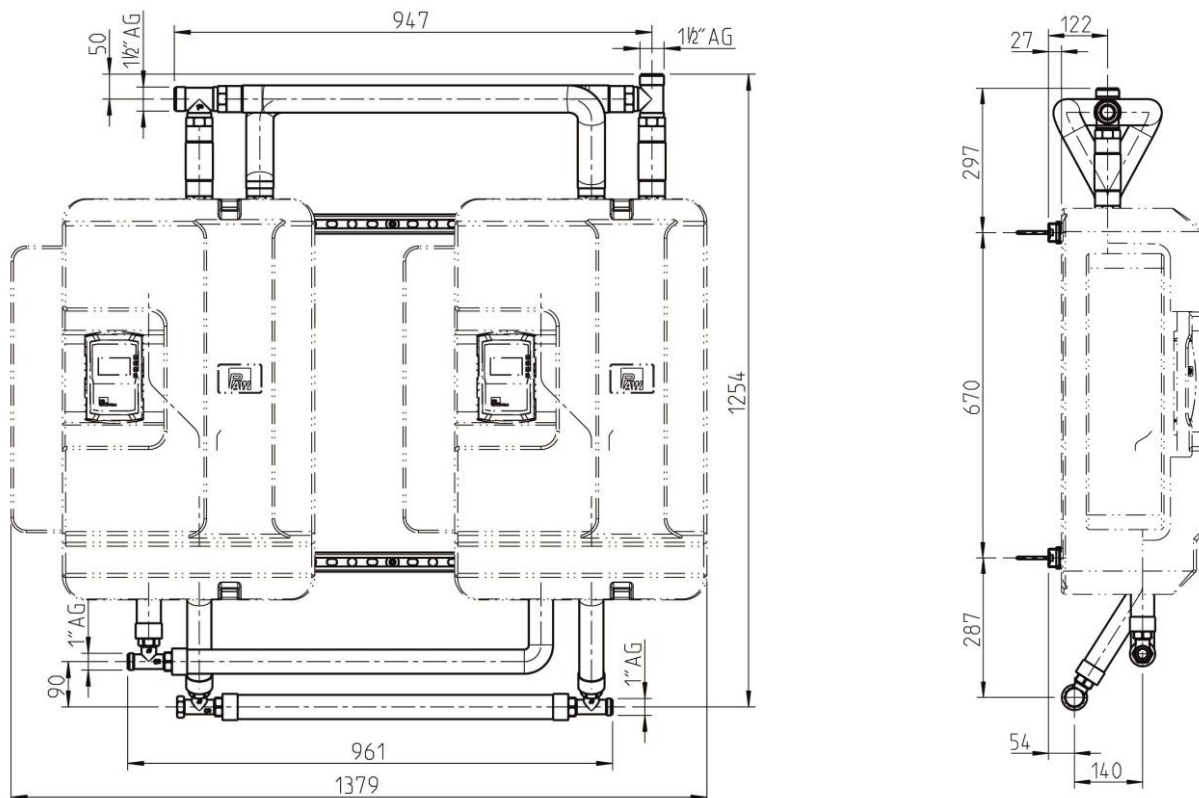

5.2 Dimensions installation set FriwaMaxi-Kaskade

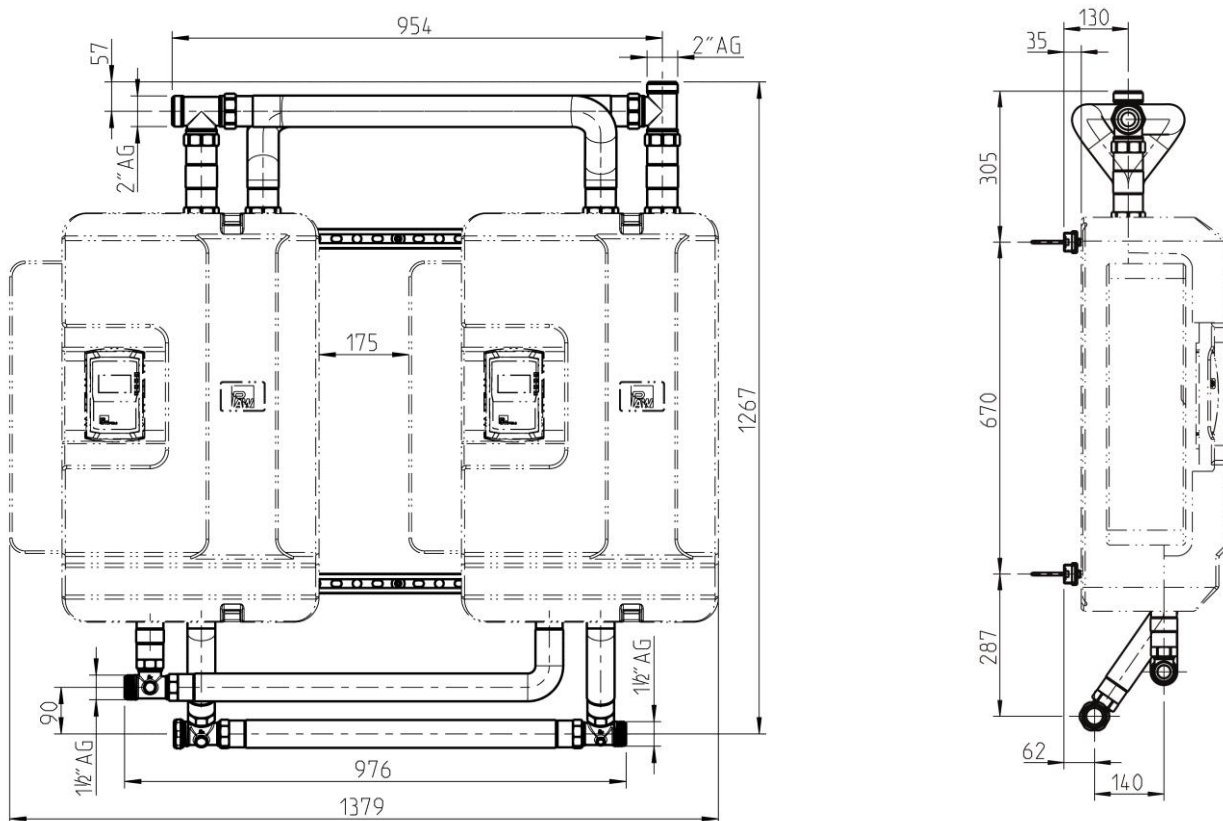

	<p>⚡ WARNING</p>
<p>Risk to life and limb due to electric shock!</p> <ul style="list-style-type: none"> ➤ Prior to commencing electrical work on the controller, pull the mains plug! ➤ Only after completing all installation work, the mains plug of the controller can be plugged into a socket. Thus, an unintentional start of the motors is avoided. 	

NOTICE

Damage to property!

The location of installation must be dry, load-carrying, frost-proof and protected against ultraviolet radiation, in order to prevent material damage of the installation.

1. Determine the mounting location of the cascade near the buffer tank.
2. Mount the upper rail to the wall with 4 screws (recommended height 1.80 m).
The cardboard template of the Friwa shows the position of the drilling holes and the distance between the upper and lower rail.
3. Fix the lower rail at the wall with 2 screws.
4. Remove the Friwa module from the packaging and put it on the box.
Notice: The station is very heavy and should be carried by two persons.
5. Open the insulating front shell.

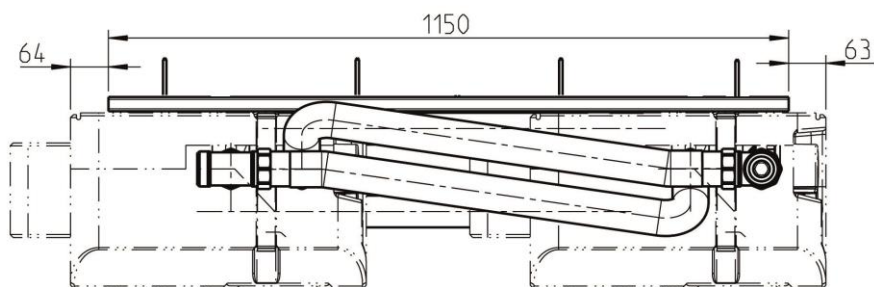

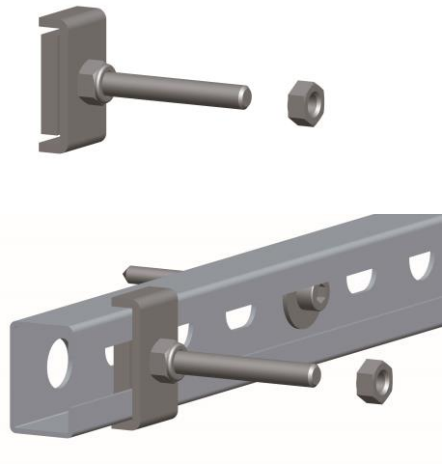

6. Slide the 4 T-head screws onto the upper rail and make sure that the big washer is placed at the outside of the rail.

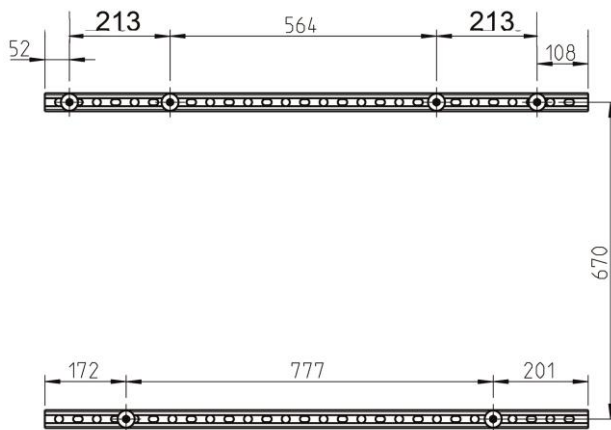

7. Adjust the T-head screws.

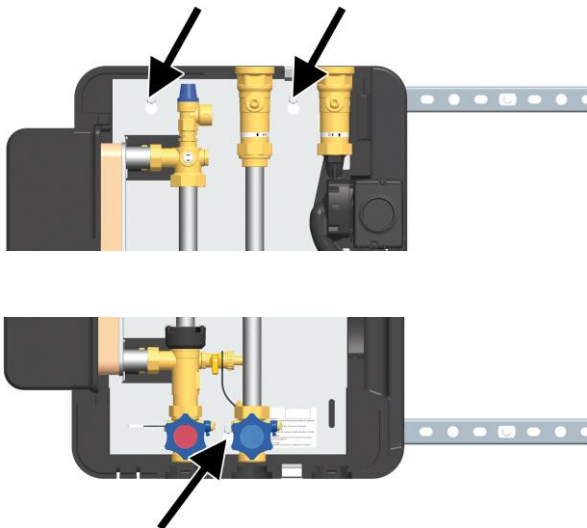

8. Hang the first station onto the screws and make sure that they protrude beyond the holes in the support sheet.

Tighten each screw with a washer and a nut.

9. Pull the station away from the lower rail towards you and slide the T-head screw onto the lower rail behind the hole. Let the screw protrude beyond it and tighten it with a washer and a nut.

10. Screw all screws manually.

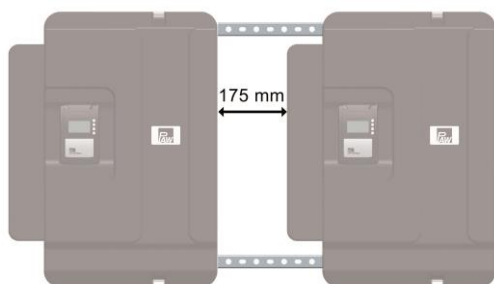

11. In the same way, mount the second Friwa to the wall. Please observe the **distance of 175 mm** between the stations.

12. Screw the screws of the second Friwa only manually because it still has to be adjusted during the connection of the connection set.

13. As long as the screws are screwed manually, the position of the stations onto the rails can be changed. For this purpose, the screws have to be relieved by an easy lifting of the stations.

14. Mount the switch valves in the stations as follows.

5.3 Installation and commissioning of the switch valve sets with 2-way electro valves

The switch valve set can only be mounted in domestic hot water modules of the type FriwaMidi or Friwa Maxi from march 2013 on. For other domestic hot water modules, other sets have to be used. If you have any questions about the required spare parts for your installation, please keep your serial number ready (it is placed in the lower right corner of the support sheet in the module).

NOTICE

Damage to property!

The location of installation must be dry, load-carrying, frost-proof and protected against ultraviolet radiation, in order to prevent material damage of the installation.

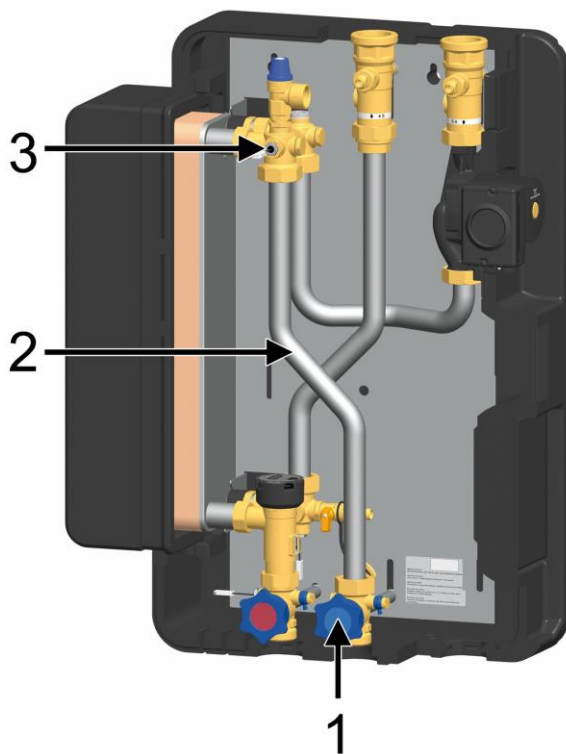

1. In the cold water inlet, dismantle the pipe (2) between the piston valve (1) and the connection piece (3).

Procedure for one module:
NOTICE

Use the new provided gaskets! Screw the thread connections at first manually and adjust the pipes in order to guarantee a low-tension installation.

1. Mount the short, straight pipe (A) to the piston valve (1).
2. Screw the zone valve (B) to it in such a way that the actuator is aligned at the side.
The cable of the actuator must point downwards (flow A→B, from the bottom to the top).
3. Screw the short end of the long double bent pipe (C) between the electro valve and the elbow piece (3).
4. Then, firmly tighten all screw connections.
5. Connect the valve to the controller in the module (see page 15 ff.).
6. Modify the other Friwa modules in the same way.
7. Connect the controllers of the cascade with the provided communication cable (see page 15 ff.).

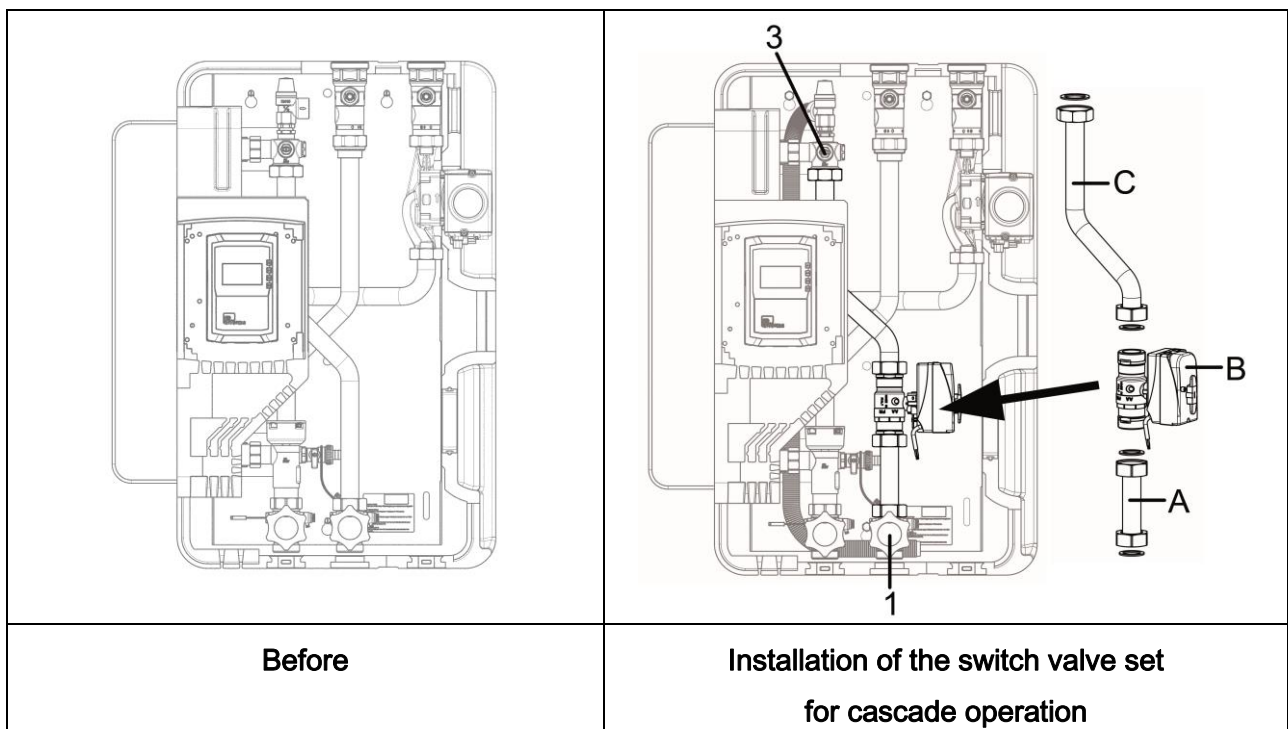

NOTICE

Use the new provided gaskets! Screw the thread connections at first manually and adjust the pipes in order to guarantee a low-tension installation.

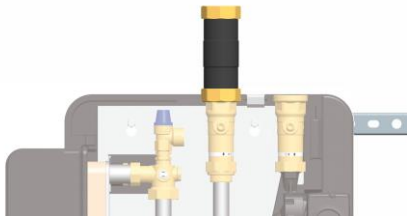

8. Screw a short, straight pipe section onto the flow connection of the left domestic hot water module.

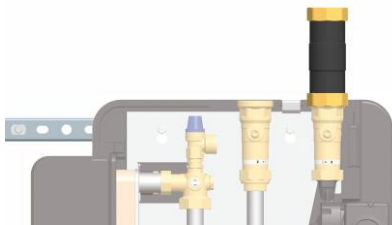

9. Screw the second short, straight pipe section onto the return connection of the right domestic hot water module.

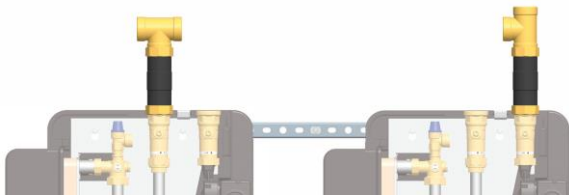

10. Screw a T-piece onto each short pipe. Depending on the piping, the T-pieces can be mounted in numerous ways (outlet to the side or to the top).

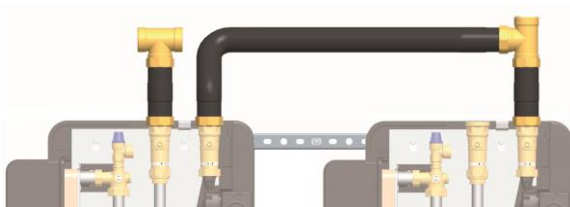

11. Screw a triple bent pipe onto the T-piece of the right module and at the return of the left module.

Notice: The pipes can not be interchanged!

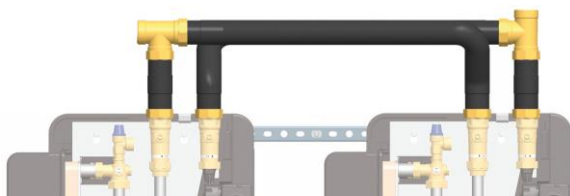

12. Screw a long triple bent pipe between the T-piece of the left station and the flow of the right station.

Notice: For the connection of the pipes, it may be necessary to slightly move the stations on the rails.

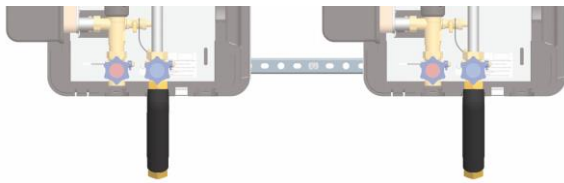

13. Screw a short single bent pipe onto each cold water inlet of the domestic hot water modules. The opening of the pipes must point backwards.



14. Screw the T-pieces onto the ends of the long, straight pipe.

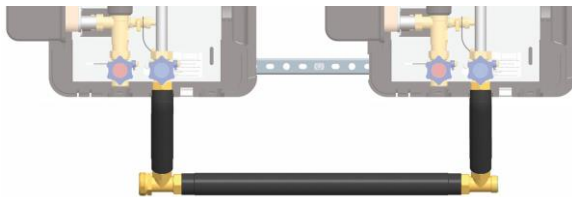

15. Mount the enclosed group between the cold water inlets of the two modules. Notice: The cold water inlet can be connected from the right or from the left. A piping according to the Tichelmann principle is recommended. Here: Inlet from the right, outlet to the left.

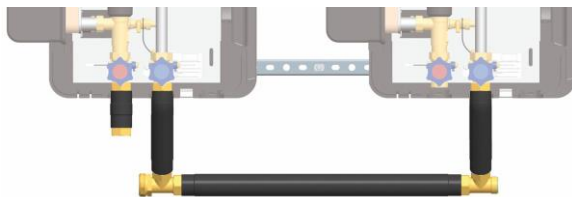

16. Screw the short, straight pipe section on the hot water connection of the left station.

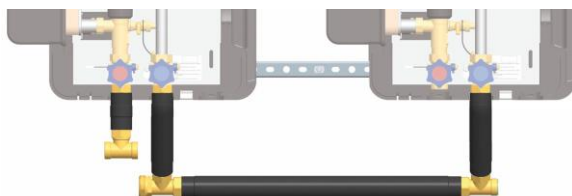

17. Screw the T-piece onto the end of this pipe.

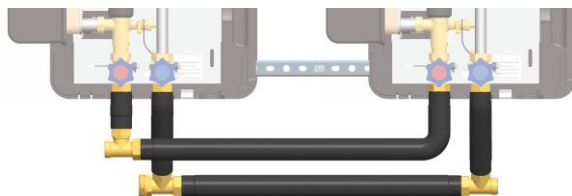

18. Screw the long single bent pipe between the T-piece of the left module and the hot water connection of the right module.

19. Firmly tighten all screw connections and check the piping for tightness.

20. Put the Friwa stations into operation according to the instructions.

5.4 Controller connection FC4.13

The following figures show how to connect the 2-way zone valves with the controller and how to connect the controllers with each other.

	<h3>WARNING</h3>
	<p>Risk to life and limb due to electric shock!</p> <ul style="list-style-type: none"> ➤ Prior to commencing electrical work on the controller, pull the mains plug and make sure that a restart is not possible. ➤ Only after completing all installation work, the mains plug of the controller can be plugged into a socket. Thus, an unintentional start of the motors is avoided.

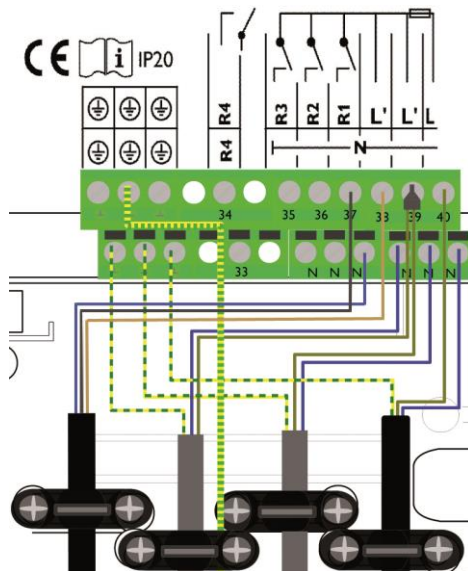

1. Open the front panel of the controller.
2. Connect the 2-way zone valve to the corresponding controller.

Black:	R1
Blue:	N
Brown:	L'

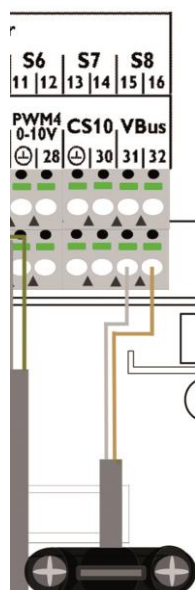

3. Connect the connecting cable to both controllers. Observe the polarity of the connection:

Brown:	VBus -
White:	VBus +

4. Mount the strain reliefs.
5. Close the front panel of the controller.
6. Provide power supply to the installation and put the controllers into operation according to the controller instructions.

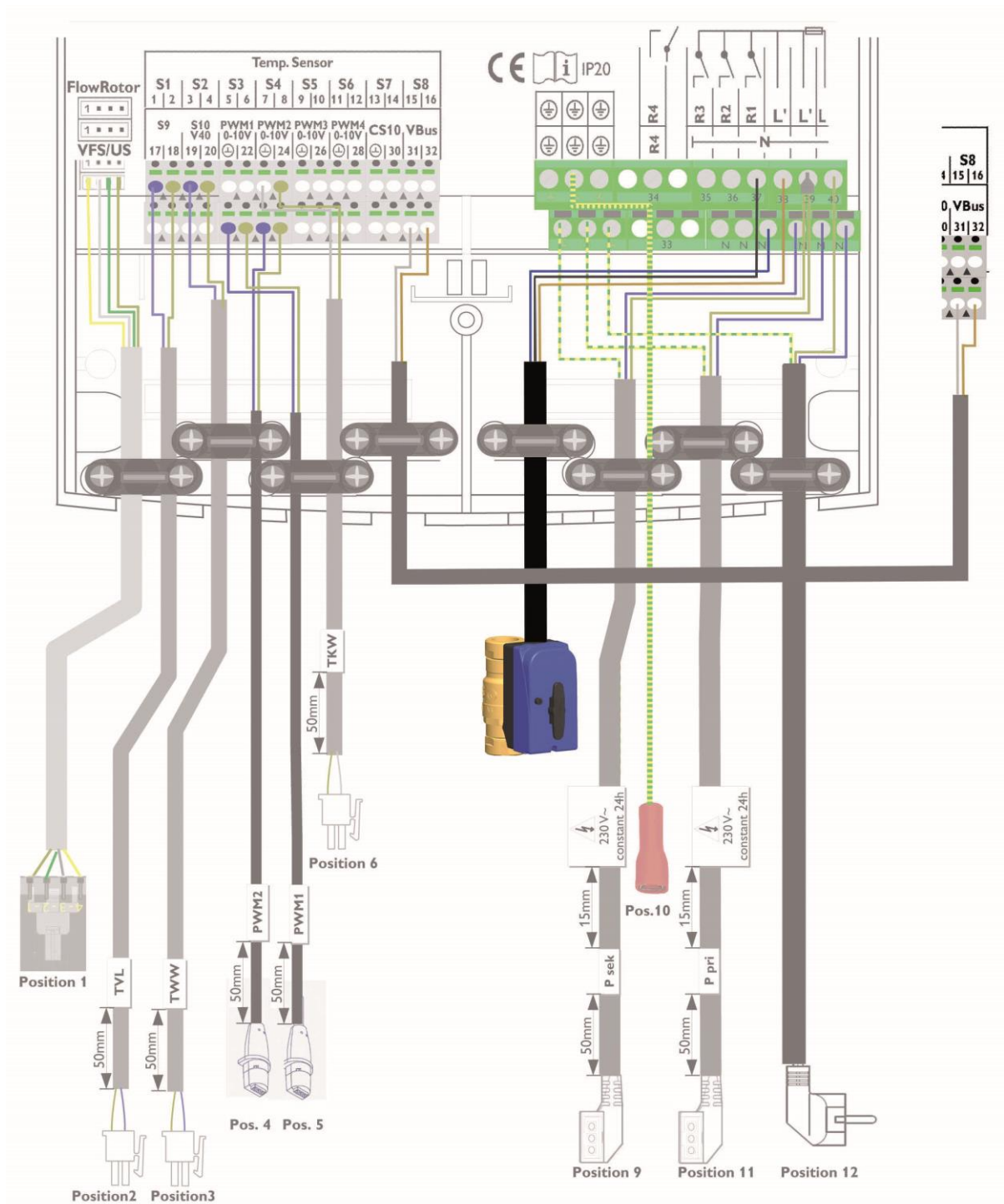

5.5 Operation of the controller FC4.13

You will find a detailed description of the commissioning of the controller in the controller instructions (see page 36/37).

If not only the switch valve but also the 3-way valve for stratification shall be connected, L' must be doubled with the help of a WAGO terminal (see example).

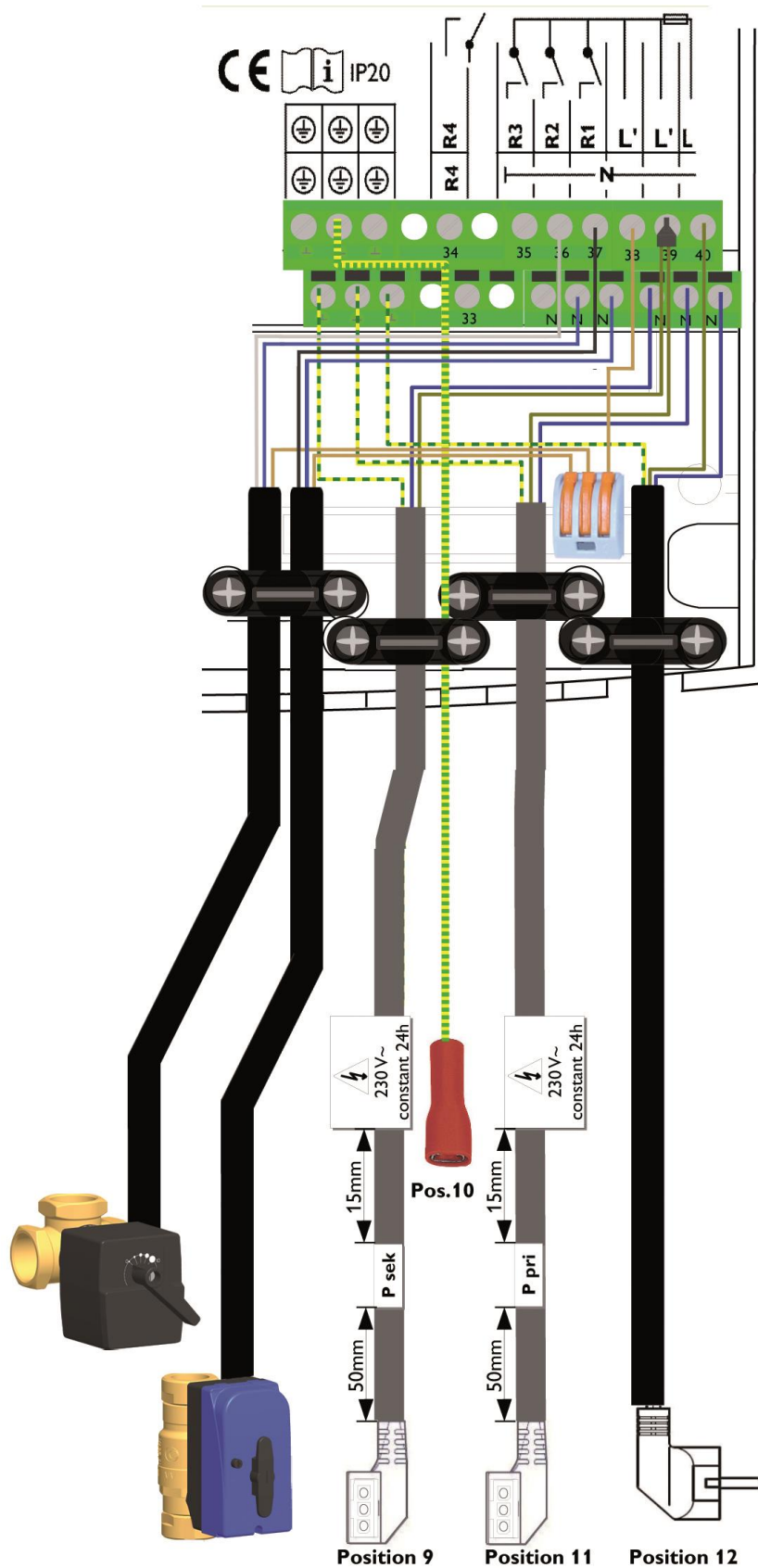

5.6 Controller connection FC3.8

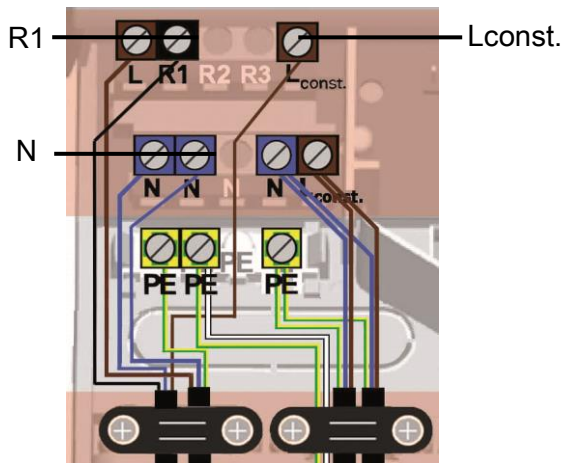

1. Open the front panel of the controller.
2. Connect the 2-way zone valve to the corresponding controller.

Black: R1
 Blue: N
 Brown: Lconst.

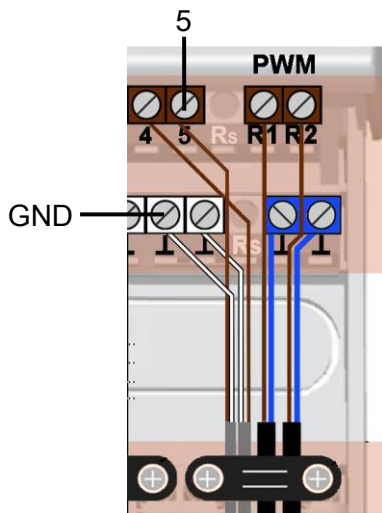

3. Connect the connecting cable to both controllers. Observe the polarity of the connection:

Brown: 5
 White: GND (±)

4. Mount the strain reliefs.
5. Close the front panel of the controller.
6. Provide power supply to the installation and put the controllers into operation according to the controller instructions.

If the master controller is concerned and if the actuator for the return distribution set shall be connected additionally, then Lconst. must be doubled via a WAGO terminal (see example on the previous page).

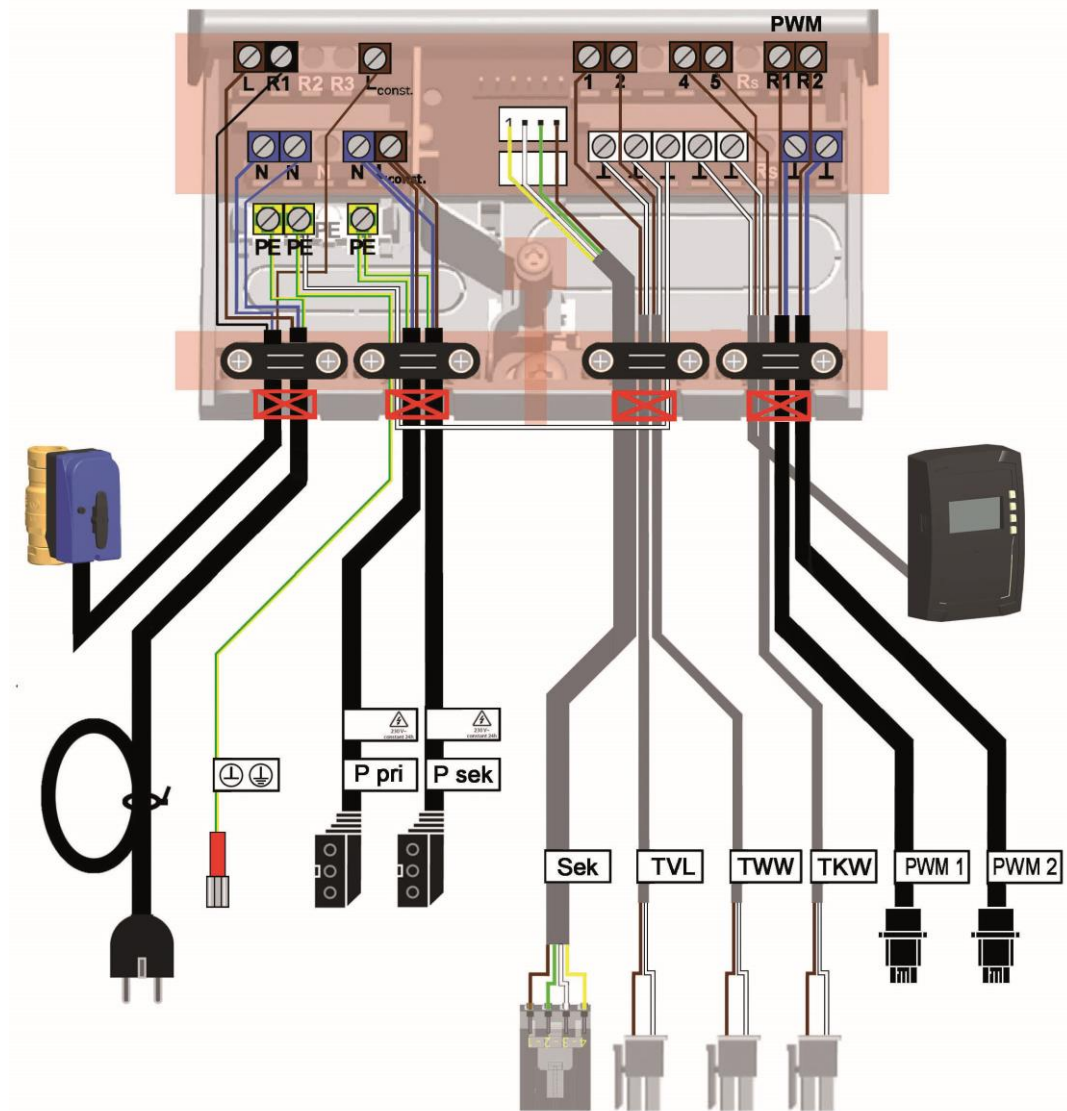

5.7 Operation of the controller FC3.8

You will find a detailed description of the operation of the controller and its functions in the controller instructions.

1. Activate the cascade operation mode F:09 (on) in both controllers.
2. In the function F:09, set one controller as master (MA) and the other controller as slave (SL).
3. The PWM cable of the circulation pump and the switch valve of the return distribution set must be connected to the master controller, if necessary

6 Scope of delivery

NOTICE

Complaints and requests/orders of spare parts will only be processed with information on the serial number!

The serial number is placed in the lower right corner of the support sheet of the station.

6.1 Installation set for FriwaMidi 2-fold cascade

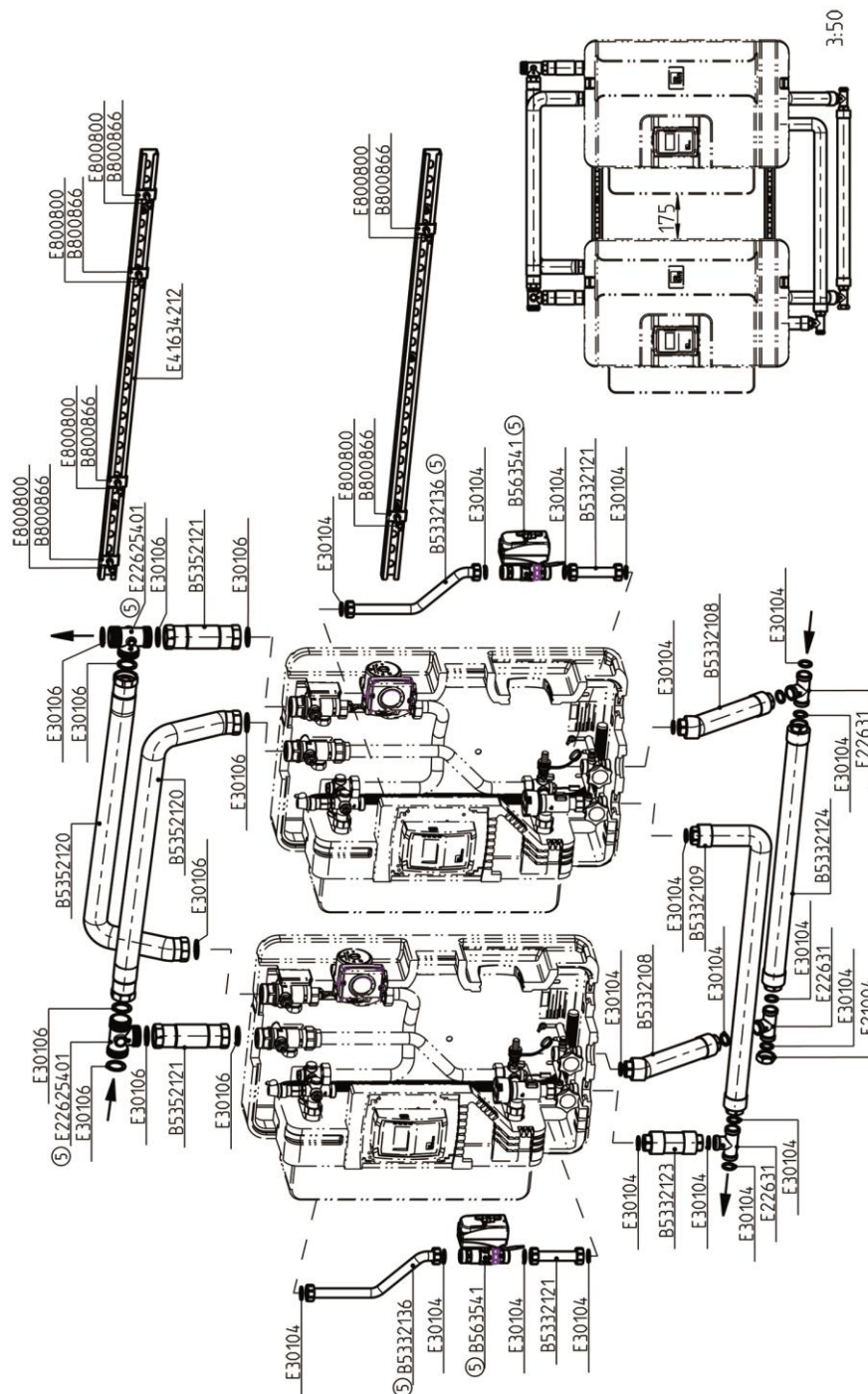

7 Technical data 2-way zone valve

Operating data	
Degree of protection	IP 44 (standard IEC 529)
Nominal voltage	230 V AC
Nominal pressure	PN 10
Max. temperature of the medium	110 °C
Setting time	12 sec / 90°
Materials	
Valve housing	CW617DW
Ball	CW617N
Valves and fittings	Stainless steel, approved for domestic hot water
Gaskets	PTFE G 502, Perox, FPM



8 Commissioning report

Installation operator _____

Location of installation _____

Serial numbers _____

Valve R1: _____

Valve R2: _____

Valve R3: _____

Valve R4: _____

Functioning during
manual operation

Valve R1: OK

Valve R2: OK

Valve R3: OK (optional)

Valve R4: OK (optional)

Pipes $\varnothing =$ mm | = m

Equipment with circulation line without circulation line

Have all pipes in the primary and secondary circuit been
checked for tightness?

Checked

Are all cables properly connected?

Checked

Are the controllers set for cascade operation mode?

Checked

Plumbing company _____

Date, signature _____

PAW GmbH & Co. KG
Böcklerstraße 11
D-31789 Hameln, Germany

www.paw.eu

Phone: +49 (0) 5151 9856 - 0

Fax: +49 (0) 5151 9856 - 98