



Rücklaufverteilungsset Friwa

Return distribution set Friwa

Set de distribution retour Friwa

Kit de distribución para retorno Friwa

Set distribuzione ritorno Friwa

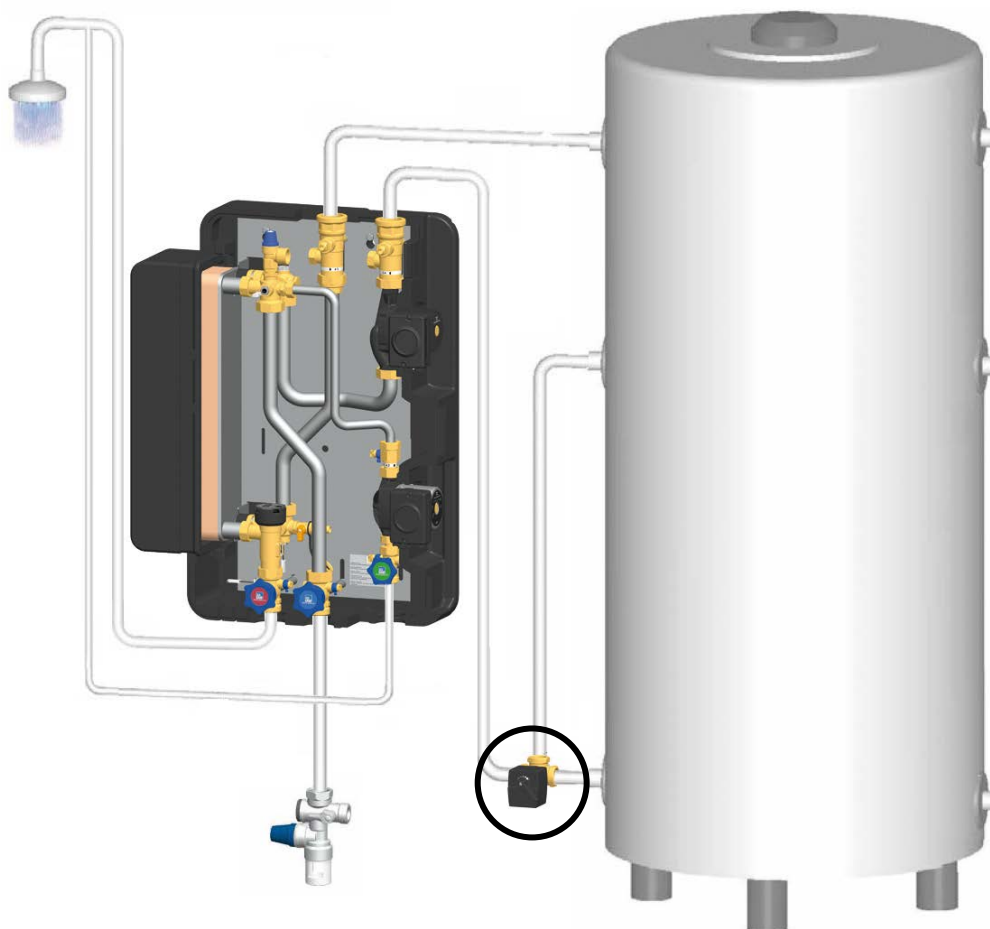

Inhalt

1	Produktbeschreibung	3
2	Sicherheitshinweise	4
3	Montagebeispiel 640423 / 640425	5
4	Montagebeispiel 640424 / 6404242 / 6404244	6
5	Verdrahtungsschema	7
5.1	Beispiel 640425 an FriwaMidi mit Regler FC3.8	7
5.2	Beispiel 640424 an FriwaMaxi mit Regler FC4.13	8
6	Einstellung des Reglers	9
6.1	Einstellung FC3.8	9
6.2	Einstellung FC4.13	9

Art. Nr. / Item no. / N° d'article / N° de art. / Nr. Art. 9964042x-mub-ml

Version / Versión / Versione V02

Technische Änderungen vorbehalten!

We reserve the right to make technical changes without notice!

Sous réserve de modifications techniques !

¡Sujeto a modificaciones técnicas!

Con riserva di modifichie tecniche!

PAW GmbH & Co. KG

Böcklerstraße 11



D-31789 Hameln, Germany

Printed in Germany - Copyright by PAW GmbH & Co. KG

1 Produktbeschreibung

Während des Zirkulationsbetriebs des Frischwassermoduls Friwa entstehen relativ hohe Rücklauftemperaturen. Damit das Rücklaufwasser nicht in den unteren Bereich des Speichers gelangt und sich dort mit dem kalten Wasser vermischt, kann mit dem Rücklaufverteilungsset Friwa das warme Wasser in den oberen Bereich des Speichers eingeschichtet werden. Das Rücklaufverteilungsset enthält ein Drei-Wege-Ventil mit motorischem Antrieb (abhängig von der Größe).



Diese Anleitung gilt für die folgenden Artikelnummern:

Rücklaufverteilungsset	Artikelnummer	
FriwaMini	640425	
FriwaMidi	640423	
FriwaMaxi	640424	
FriwaMidi-Kaskade FriwaMaxi-Kaskade	6404242	
FriwaMega-Kaskade	6404244	

2 Sicherheitshinweise

Die Installation und Inbetriebnahme sowie der Anschluss der elektrischen Komponenten setzen Fachkenntnisse voraus, die einem anerkannten Berufsabschluss als Anlagenmechaniker/in für Sanitär-, Heizungs- und Klimatechnik bzw. einem Beruf mit vergleichbarem Kenntnisstand entsprechen [Fachmann]. Bei der Installation und Inbetriebnahme muss folgendes beachtet werden:

- Einschlägige regionale und überregionale Vorschriften
- Unfallverhütungsvorschriften der Berufsgenossenschaft
- Anweisungen und Sicherheitshinweise dieser Anleitung

	 WARNUNG
	<p>Gefahr für Leib und Leben durch Stromschlag!</p> <ul style="list-style-type: none"> ➤ Vor elektrischen Arbeiten am Regler den Netzstecker ziehen! ➤ Stecken Sie den Netzstecker des Reglers erst nach Abschluss aller Installationsarbeiten in eine Steckdose. So verhindern Sie ein unbeabsichtigtes Anlaufen der Motoren.

3 Montagebeispiel 640423 / 640425

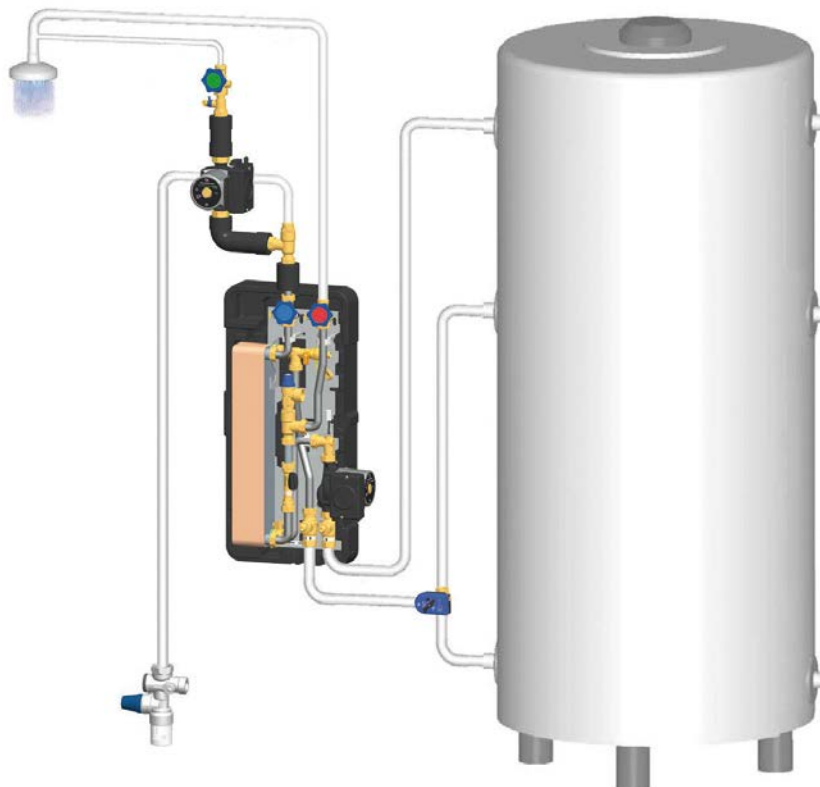

Bei Montage der FriwaMini oder FriwaMidi rechts vom Speicher:
 Ändern Sie die Durchflussrichtung des Umschaltventils (siehe separate Anleitung des Umschaltventils).

Vorrang (Motor stromlos)	Nachrang (Motor aktiviert)

4 Montagebeispiel 640424 / 6404242 / 6404244

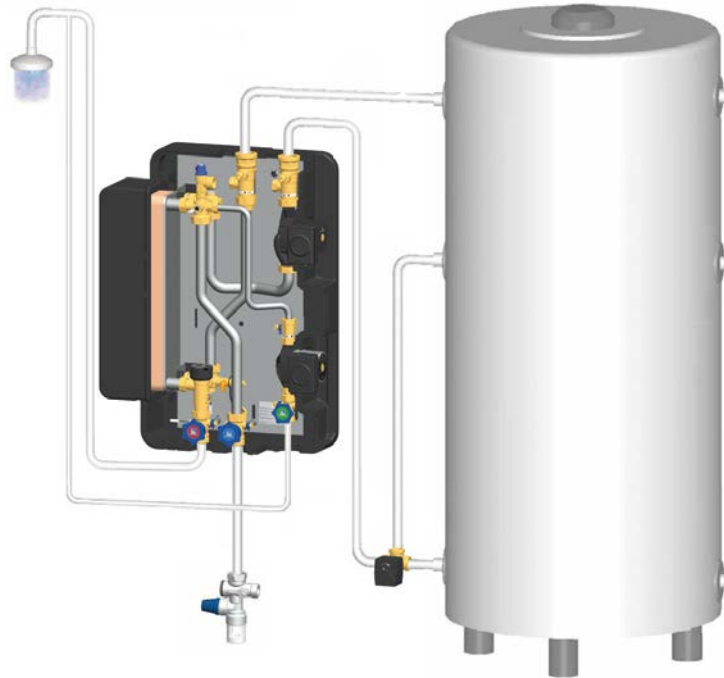

Bei Montage der FriwaMidi oder FriwaMaxi rechts vom Speicher:

Ändern Sie den Drehsinn des Stellmotors (siehe separate Anleitung zum Stellmotor).

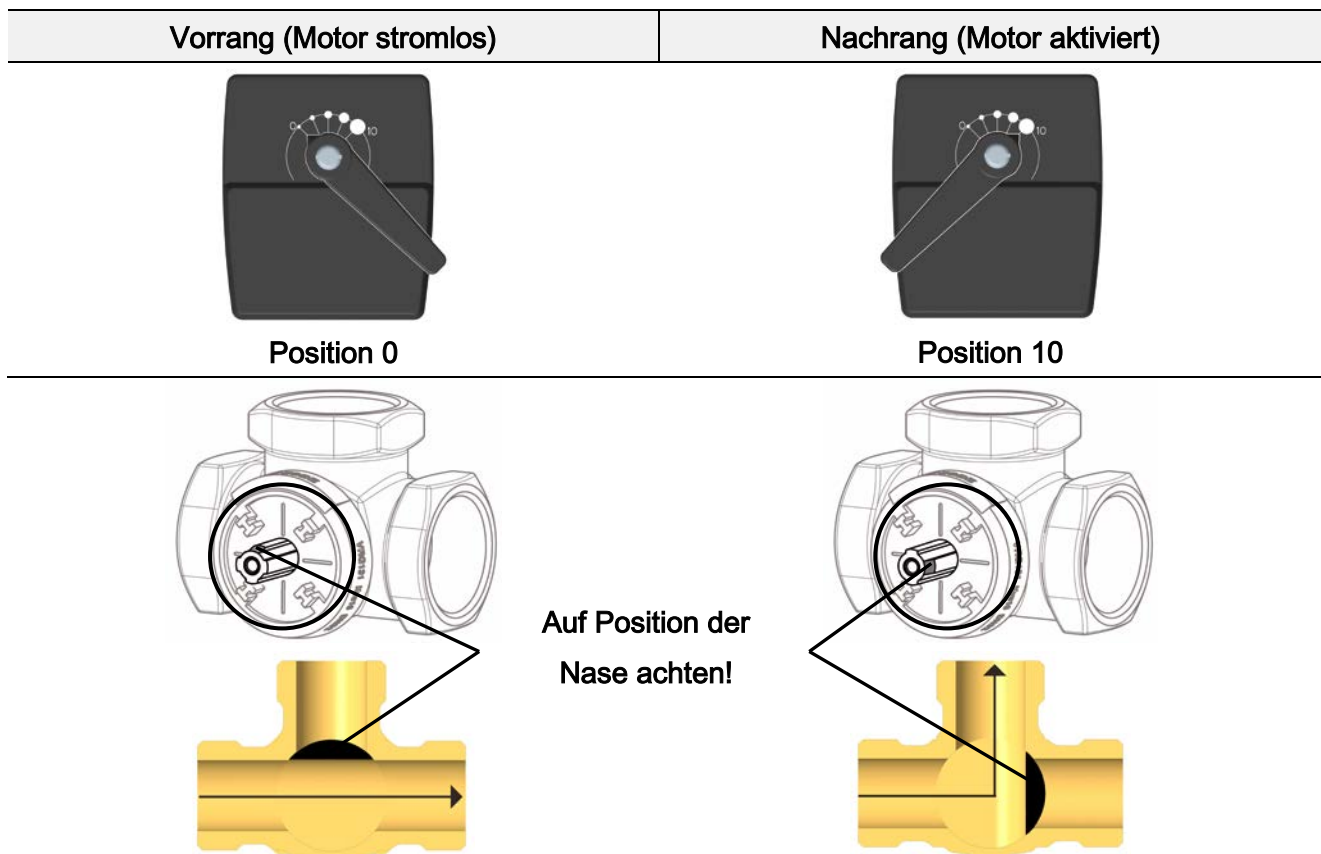

5 Verdrahtungsschema

Im Anschlussschema ist dargestellt, wie Sie das Drei-Wege-Ventil mit der Regelung verdrachten.

Anschluss an Regler	640423 / 640425	640424 / 6404242 / 6404244
Netzphase (L _{const.})	braun	braun
Nullleiter (N)	blau	blau
Schaltphase (an R2)	schwarz	weiß
---	rot: frei	---

5.1 Beispiel 640425 an FriwaMidi mit Regler FC3.8

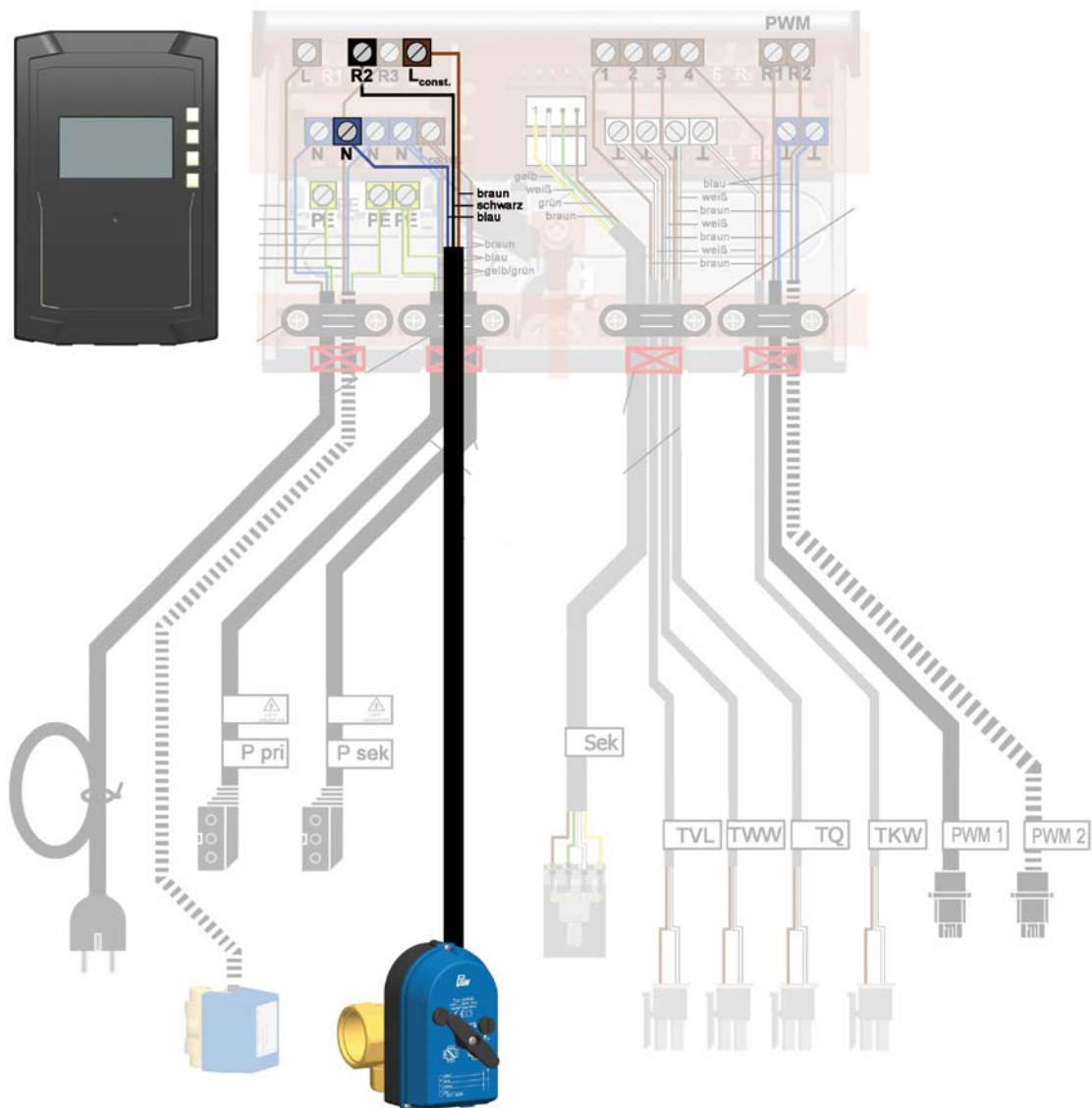

5.2 Beispiel 640424 an FriwaMaxi mit Regler FC4.13

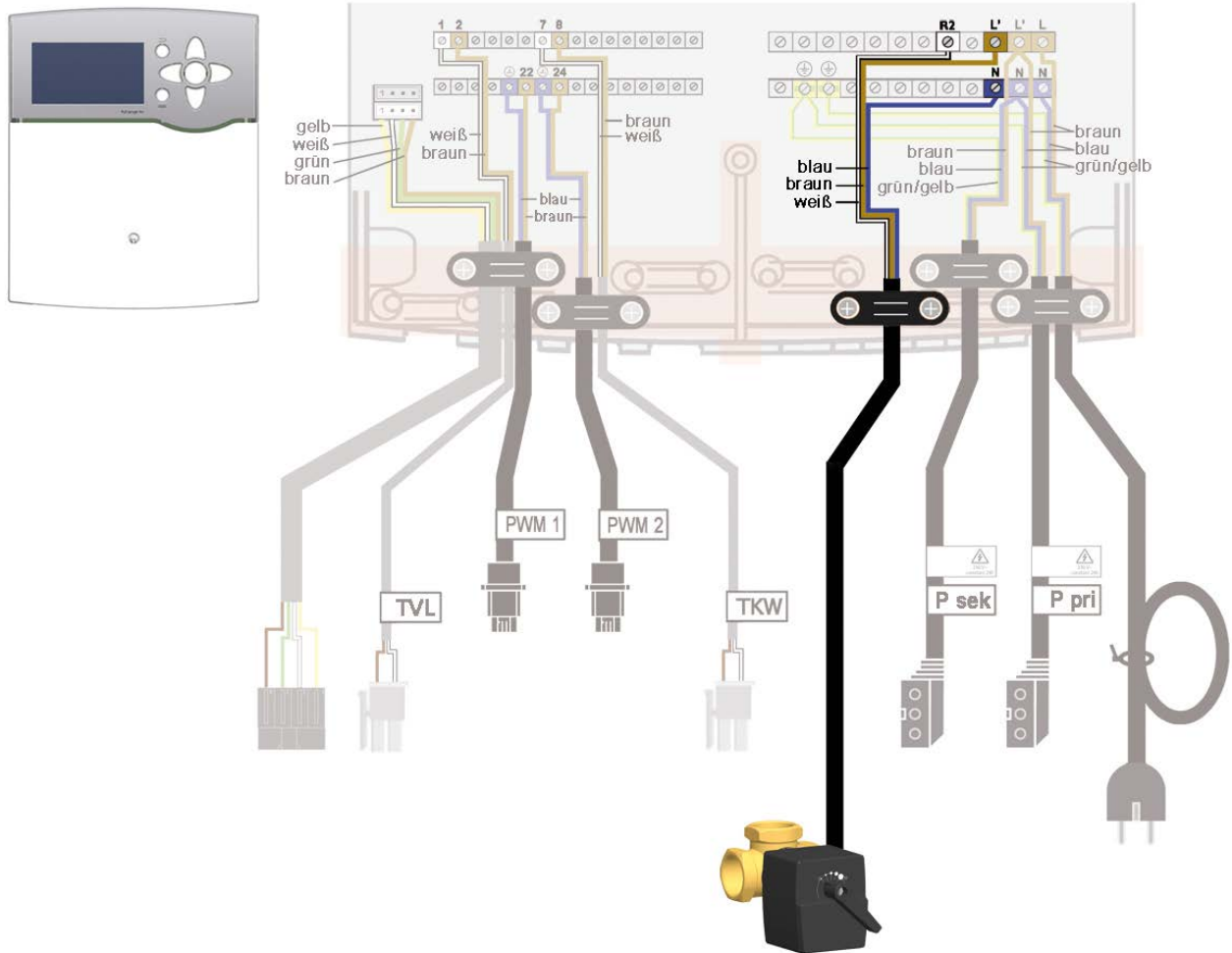

6 Einstellung des Reglers

6.1 Einstellung FC3.8

Aktivieren Sie die Funktion **"Verteilventil im Rücklauf"** am Regler. Beachten Sie auch die gesonderte Anleitung des Reglers!

Menü: Hauptmenü / Func / F:03 Verteilventil im Rücklauf auf „on“

6.2 Einstellung FC4.13

Aktivieren Sie die Funktion **"RL-Einschichtung"** am Regler. Beachten Sie auch die gesonderte Anleitung des Reglers!

Menü: Hauptmenü / Zirkulation / RL-Einschichtung / Ja



Content

1	Product description	11
2	Safety instructions.....	12
3	Mounting example 640423 / 640425	13
4	Mounting example 640424 / 6404242 / 6404244	14
5	Wiring plan.....	15
5.1	Example: 640425 at FriwaMidi with controller FC3.8.....	15
5.2	Example: 640424 at FriwaMaxi with controller FC4.13.....	16
6	Controller adjustment.....	17
6.1	Adjustments for FC3.8	17
6.2	Adjustments for FC4.13	17

Art. Nr. / Item no. / N° d'article / N° de art. / Nr. Art. 9964042x-mub-ml

Version / Versión / Versione V02

Technische Änderungen vorbehalten!

We reserve the right to make technical changes without notice!

Sous réserve de modifications techniques !

¡Sujeto a modificaciones técnicas!

Con riserva di modifichite tecniche!

PAW GmbH & Co. KG

Böcklerstraße 11

D-31789 Hameln, Germany



Printed in Germany - Copyright by PAW GmbH & Co. KG

1 Product description

In circulation mode, the return temperatures of the Friwa domestic hot water module are relatively high. To prevent the return water from mixing with the cold water in the lower section of the storage tank, the Friwa return distribution set allows to feed the warm water into the upper section.

The return distribution set contains a three-way valve with an electric actuator (depending on the size).



These instructions refer to the following articles:

Return distribution set	Item number	
FriwaMini	640425	
FriwaMidi	640423	
FriwaMaxi	640424	
FriwaMidi-Kaskade FriwaMaxi-Kaskade	6404242	
FriwaMega-Kaskade	6404244	

2 Safety instructions

The installation and commissioning as well as the connection of electrical components require technical knowledge commensurate with a recognised vocational qualification as a fitter for plumbing, heating and air conditioning technology, or a profession requiring a comparable level of knowledge [specialist]. The following must be observed during installation and commissioning:

- Relevant local and national regulations
- Accident prevention regulations of the professional association
- Instructions and safety instructions mentioned in this manual

	 WARNING
	<p>Risk to life and limb due to electric shock!</p> <ul style="list-style-type: none"> ➤ Prior to commencing electrical work on the controller, pull the mains plug! ➤ Only after completing all installation work, plug the mains plug of the controller into a socket. This avoids an unintentional start of the motors.

3 Mounting example 640423 / 640425

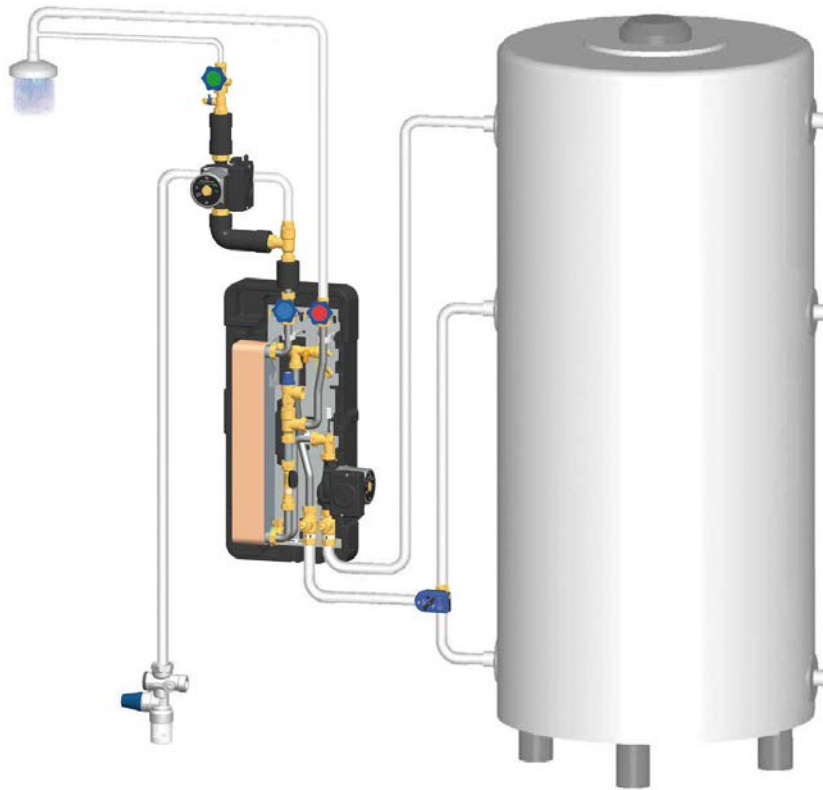

For the assembly of the FriwaMini or FriwaMidi to the right of the storage tank:
Change the flow direction of the switch valve (see separate instructions of the switch valve).

<p style="text-align: center;">Priority (actuator at zero current)</p>	<p style="text-align: center;">Lower priority (actuator activated)</p>

4 Mounting example 640424 / 6404242 / 6404244

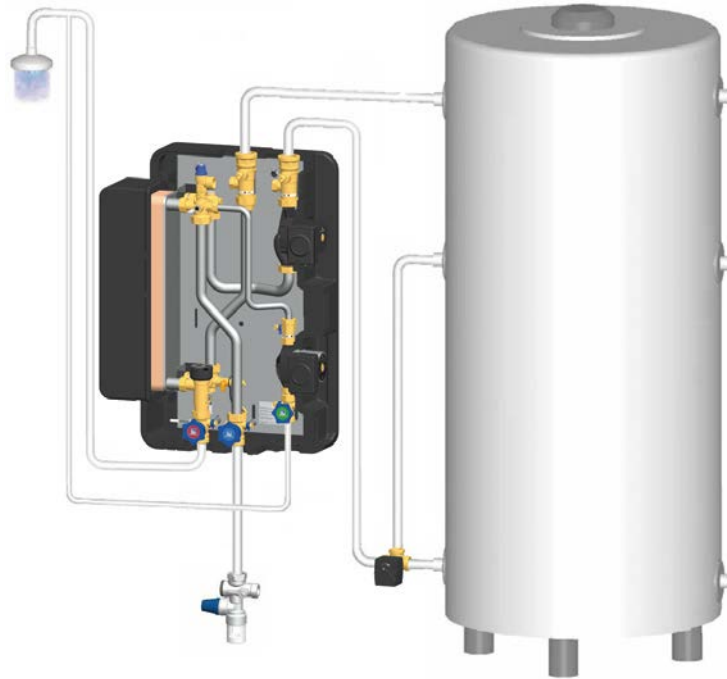

For the assembly of the FriwaMidi or FriwaMaxi to the right of the storage tank:
Change the sense of rotation of the actuator (see separate instructions of the actuator)

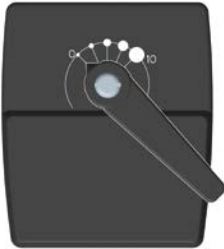
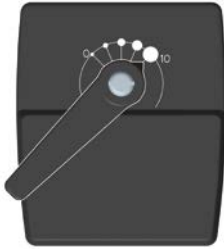
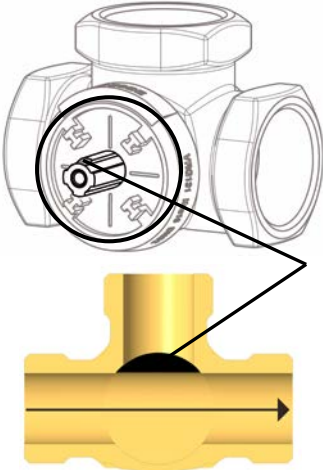
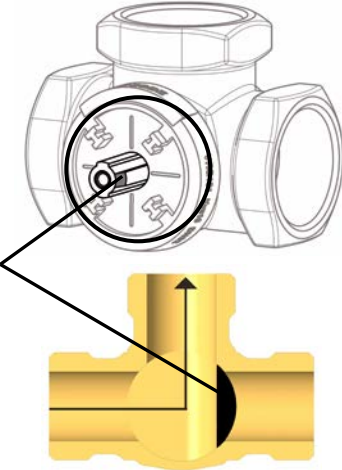
Priority (actuator at zero current)	Lower priority (actuator activated)
 <p data-bbox="395 1529 533 1563">Position 0</p>	 <p data-bbox="1050 1529 1187 1563">Position 10</p>
	<p data-bbox="655 1798 900 1883">Watch the position of the nose!</p> 

5 Wiring plan

The wiring plan shows how to connect the temperature sensor and the three-way valve with the controller.

Connection to controller	640423 / 640425	640424 / 6404242 / 6404244
Mains phase (L _{const.})	brown	brown
Neutral conductor (N)	blue	blue
Commutation (at R2)	black	white
---	red: free	---

5.1 Example: 640425 at FriwaMidi with controller FC3.8

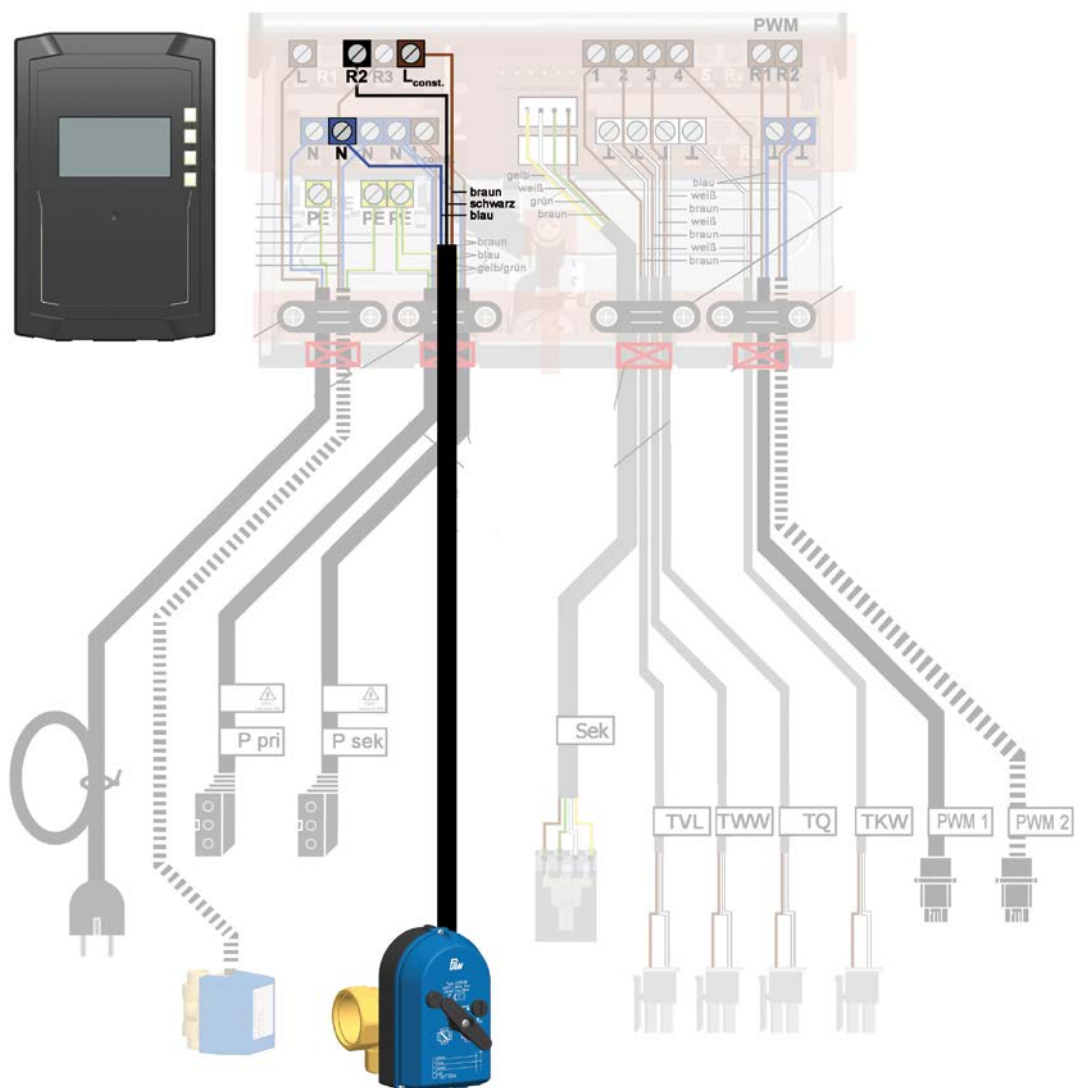

5.2 Example: 640424 at FriwaMaxi with controller FC4.13

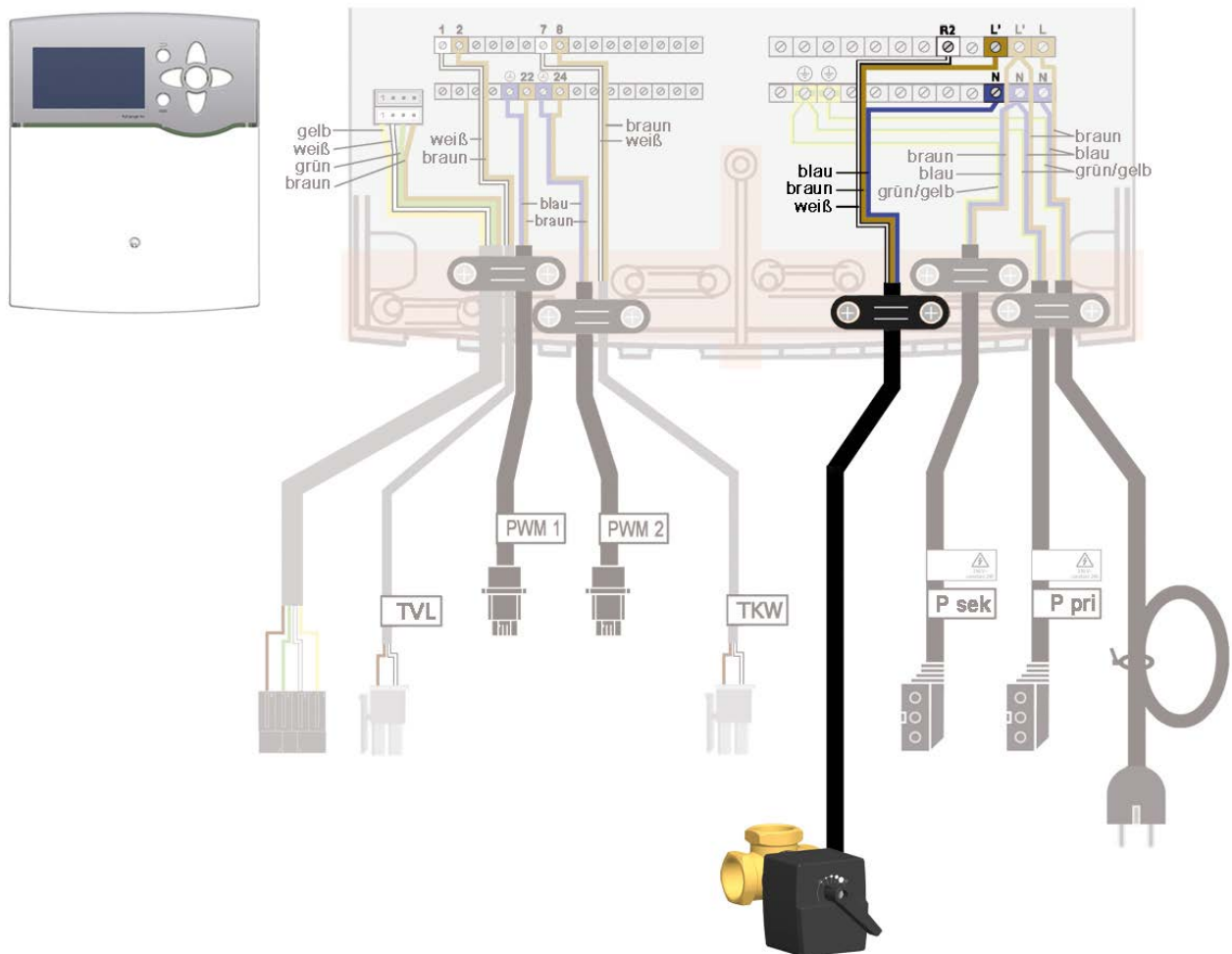

6 Controller adjustment

6.1 Adjustments for FC3.8

Activate the function "**diverting valve in the return**" at the controller. Observe the separate instructions regarding the controller!

Menu: Main menu / Func / F:03 diverting valve in the return „on“

6.2 Adjustments for FC4.13

Activate the function "**Stratified return**" at the controller. Observe the separate instructions regarding the controller!

Menu: Main menu / Circulation / Strat. return / Yes

Table des matières

1	Description du produit	19
2	Consignes de sécurité	20
3	Exemple de montage 640423 / 640425.....	21
4	Exemple de montage 640424 / 6404242 / 6404244	22
5	Schéma de câblage	23
5.1	Exemple : 640425 au FriwaMidi avec régulateur FC3.8	23
5.2	Exemple : 640424 au FriwaMaxi avec régulateur FC4.13	24
6	Ajustage du régulateur	25
6.1	Ajustage du FC3.8	25
6.2	Ajustage du FC4.13	25

Art. Nr. / Item no. / N° d'article / N° de art. / Nr. Art. 9964042x-mub-ml

Version / Versión / Versione V02

Technische Änderungen vorbehalten!

We reserve the right to make technical changes without notice!

Sous réserve de modifications techniques !

¡Sujeto a modificaciones técnicas!

Con riserva di modifichitecniche!

PAW GmbH & Co. KG

Böcklerstraße 11

D-31789 Hameln, Allemagne



Printed in Germany - Copyright by PAW GmbH & Co. KG

1 Description du produit

Pendant le mode de circulation du Friwa module d'ECS instantanée, la température retour est relativement élevée. Afin que l'eau de retour ne pénètre pas dans la partie inférieure du ballon et ne se mélange pas avec l'eau froide, l'eau chaude peut être stockée dans la partie supérieure du ballon à l'aide du set de distribution retour Friwa.

Le set de distribution retour comprend une vanne trois voies équipée d'un servomoteur électrique (en fonction de la taille).



Les présentes instructions sont valides pour les numéros d'article suivants :

Set de distribution retour	N° d'article	
FriwaMini	640425	
FriwaMidi	640423	
FriwaMaxi	640424	
FriwaMidi-Kaskade FriwaMaxi-Kaskade	6404242	
FriwaMega-Kaskade	6404244	

2 Consignes de sécurité

L'installation et la mise en service ainsi que le raccordement des composants électriques exigent des connaissances spéciales qui correspondent à une formation professionnelle reconnue de mécanicien spécialisé dans le domaine de la technique sanitaire, du chauffage et de la climatisation ou à une qualification comparable [Expert]. Lors de l'installation et la mise en service, il faut respecter :

- Les règles nationales et régionales s'appliquant au secteur
- Les directives sur la prévention des accidents de travail
- Les instructions et consignes de sécurité de ce document

	 AVERTISSEMENT
	<p>Danger de mort par électrocution !</p> <ul style="list-style-type: none"> ➤ Débranchez la fiche de réseau avant de procéder à des interventions électriques sur le régulateur ! ➤ Ne branchez la fiche secteur du régulateur dans une prise qu'après avoir terminé l'installation. Ainsi, vous évitez une mise en marche involontaire des moteurs.

3 Exemple de montage 640423 / 640425

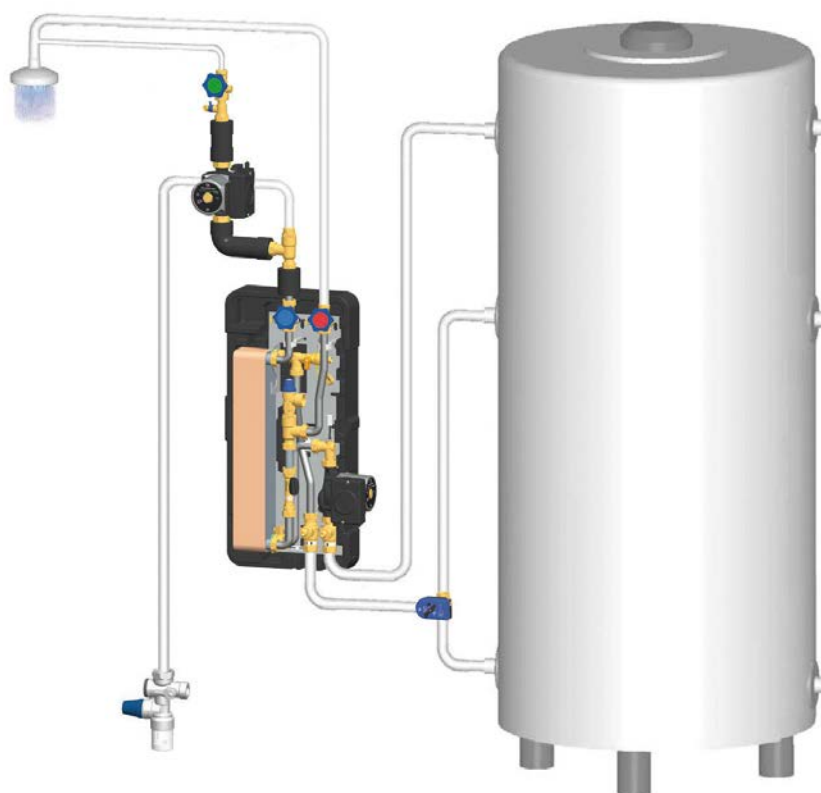



Pour le montage de la FriwaMini ou FriwaMidi à droite du ballon de stockage :
Changez le sens de circulation de la vanne d'inversion (voir notice séparée de la vanne d'inversion).

Prioritaire (servomoteur sans courant)	Secondaire (servomoteur activé)

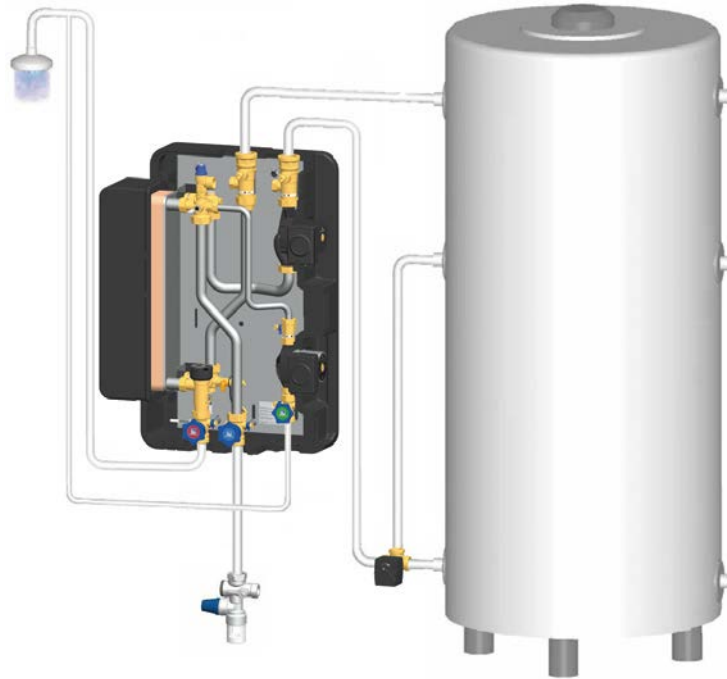
4 Exemple de montage 640424 / 6404242 / 6404244

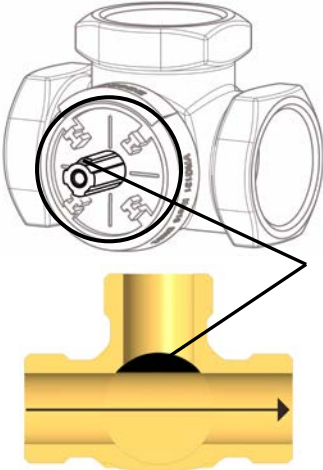
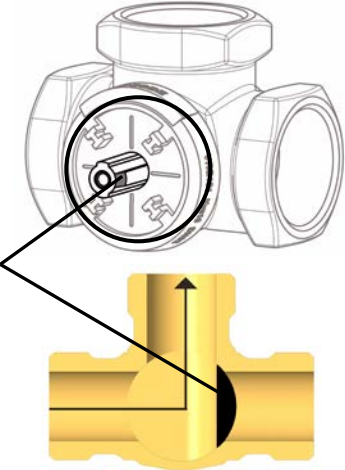

Pour le montage de la FriwaMidi ou FriwaMaxi à droite du ballon de stockage :
Changez le sens de rotation du servomoteur (voir notice séparée du servomoteur).

Prioritaire (servomoteur sans courant)	Secondaire (servomoteur activé)
 <p data-bbox="395 1529 533 1563">Position 0</p>	 <p data-bbox="1043 1529 1181 1563">Position 10</p>
	

Veillez à la position du nez !

5 Schéma de câblage

La manière dont la sonde de température et la vanne trois voies doivent être reliées au système de régulation est représentée dans le schéma de raccordement.

Raccord au régulateur	640423 / 640425	640424 / 6404242 / 6404244
Réseau (L _{const.})	brun	brun
Neutre (N)	bleu	bleu
Commutation (à R2)	noir	blanc
---	rouge : libre	---

5.1 Exemple : 640425 au FriwaMidi avec régulateur FC3.8

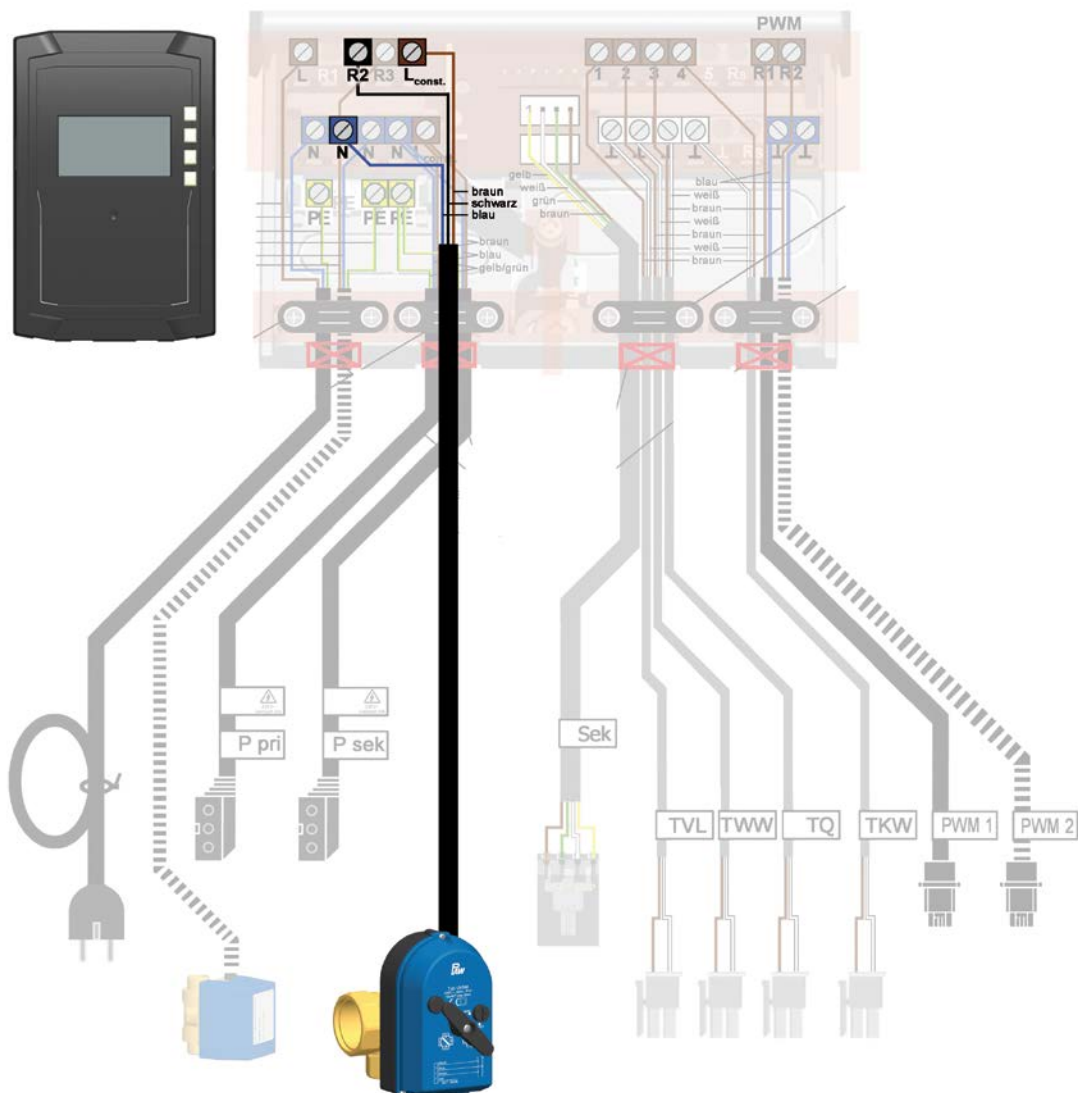

5.2 Exemple : 640424 au FriwaMaxi avec régulateur FC4.13

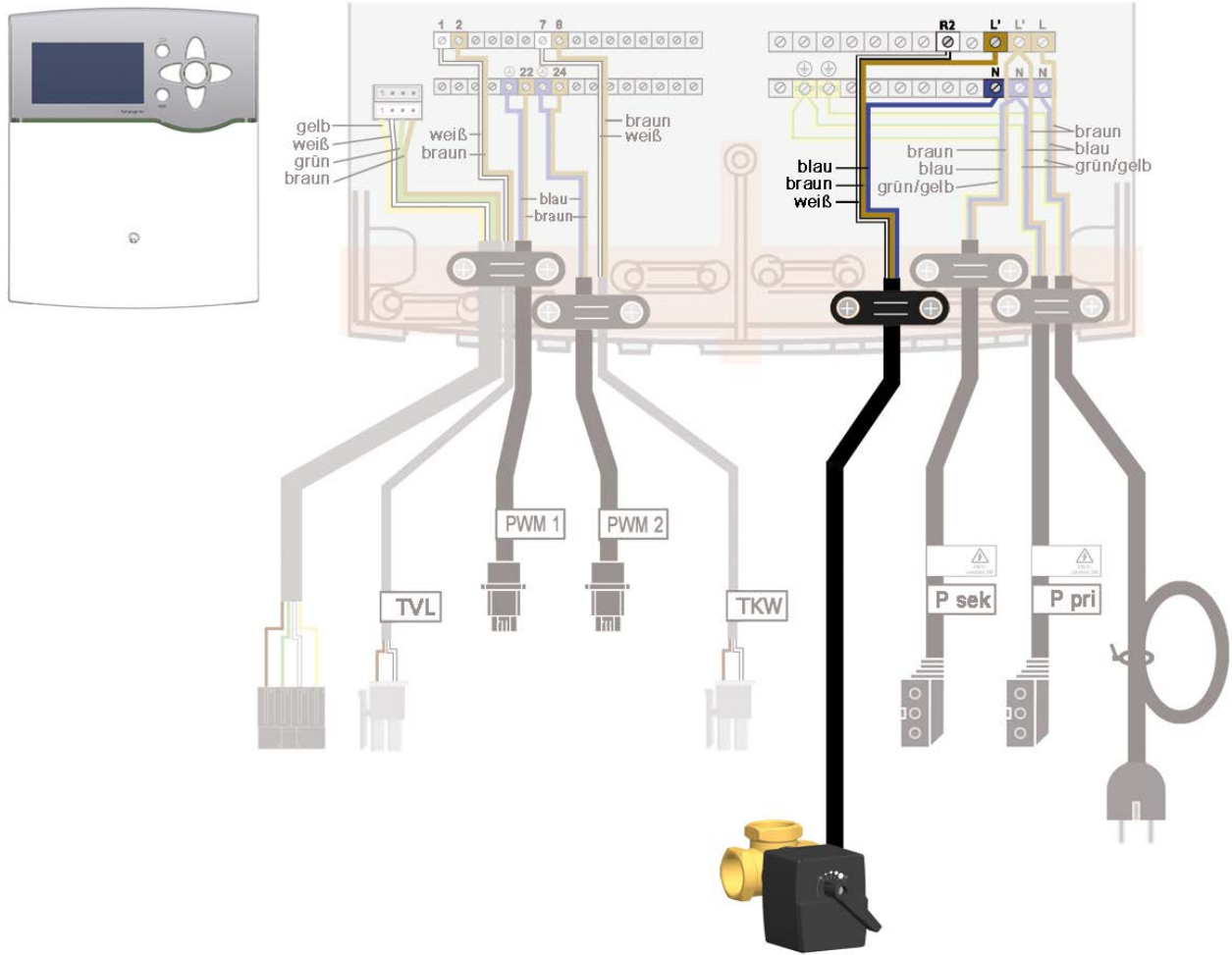

6 Ajustage du régulateur

6.1 Ajustage du FC3.8

Activez la fonction "**Vanne de répartition au retour**" au régulateur. Consultez les instructions séparées concernant le régulateur !

Menu : Menu principal / Func / F:03 Vanne de répartition au retour sur „on“

6.2 Ajustage du FC4.13

Activez la fonction "**Stratification du retour**" au régulateur. Consultez les instructions séparées concernant le régulateur !

Menu : Menu principal / Circulation / Ret. stratifié / Oui

Índice

1	Descripción del producto.....	27
2	Indicaciones de seguridad	28
3	Ejemplo de montaje 640423 / 640425.....	29
4	Ejemplo de montaje 640424 / 6404242 / 6404244	30
5	Esquema de cableado	31
5.1	Ejemplo: 640425 al FriwaMidi con regulador FC3.8.....	31
5.2	Ejemplo: 640424 al FriwaMaxi con regulador FC4.13	32
6	Ajuste del regulador	33
6.1	Ajuste del FC3.8	33
6.2	Ajuste del FC4.13	33

Art. Nr. / Item no. / N° d'article / N° de art. / Nr. Art. 9964042x-mub-ml

Version / Versión / Versione V02

Technische Änderungen vorbehalten!

We reserve the right to make technical changes without notice!

Sous réserve de modifications techniques !

¡Sujeto a modificaciones técnicas!

Con riserva di modifichite tecniche!

PAW GmbH & Co. KG

Böcklerstraße 11

D-31789 Hameln, Alemania

Printed in Germany - Copyright by PAW GmbH & Co. KG

1 Descripción del producto

Durante el funcionamiento de circulación del módulo de agua fresca Friwa se forman temperaturas relativamente altas en el retorno. Para evitar que agua del retorno entra en la parte inferior del acumulador y se mezcla ahí con el agua fría, puede almacenar por medio del kit de distribución Friwa el agua caliente en la parte superior del acumulador.

El kit de distribución para retorno contiene una válvula de tres vías con actuador electromotor (depende del tamaño).



Estas instrucciones son válidas para los siguientes números de artículo:

Kit de distribución para retorno	Nº de artículo	
FriwaMini	640425	
FriwaMidi	640423	
FriwaMaxi	640424	
FriwaMidi-Kaskade FriwaMaxi-Kaskade	6404242	
FriwaMega-Kaskade	6404244	

2 Indicaciones de seguridad

La instalación y el funcionamiento, así como la conexión de los componentes eléctricos requieren conocimientos técnicos correspondientes a la profesión de mecánico de instalaciones sanitarias, de calefacción y aire acondicionado u otra profesión con similar nivel de conocimientos técnicos [técnico especializado]. Durante la instalación y la puesta en servicio debe prestarse atención a lo siguiente:

- normativa local, regional y estatal correspondiente
- normativa sobre prevención de accidentes de la asociación profesional
- instrucciones e indicaciones de seguridad del presente manual

	 ADVERTENCIA
	<p>¡Peligro de muerte o lesiones corporales por electrocución!</p> <ul style="list-style-type: none"> ➤ ¡Extraer el enchufe de alimentación de red antes de efectuar trabajos en componentes eléctricos del regulador! ➤ Enchufe la clavija del regulador a una toma de corriente una vez concluidos todos los trabajos de instalación. De esta forma se evita la puesta en marcha accidental de los motores.

3 Ejemplo de montaje 640423 / 640425

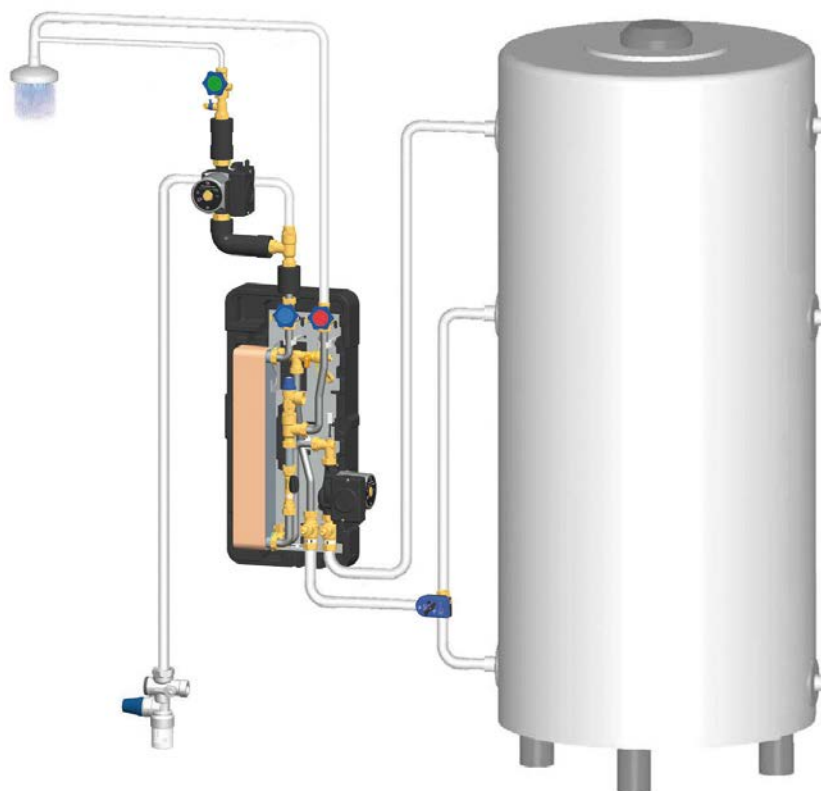

En caso de una instalación del módulo FriwaMini o FriwaMidi a la derecha del acumulador:
Cambie la dirección de circulación de la válvula de inversión (véase el manual por separado de la
válvula de inversión).

<p>Prioridad primaria (accionador desactivado)</p>	<p>Prioridad secundaria (servomotor activado)</p>

4 Ejemplo de montaje 640424 / 6404242 / 6404244

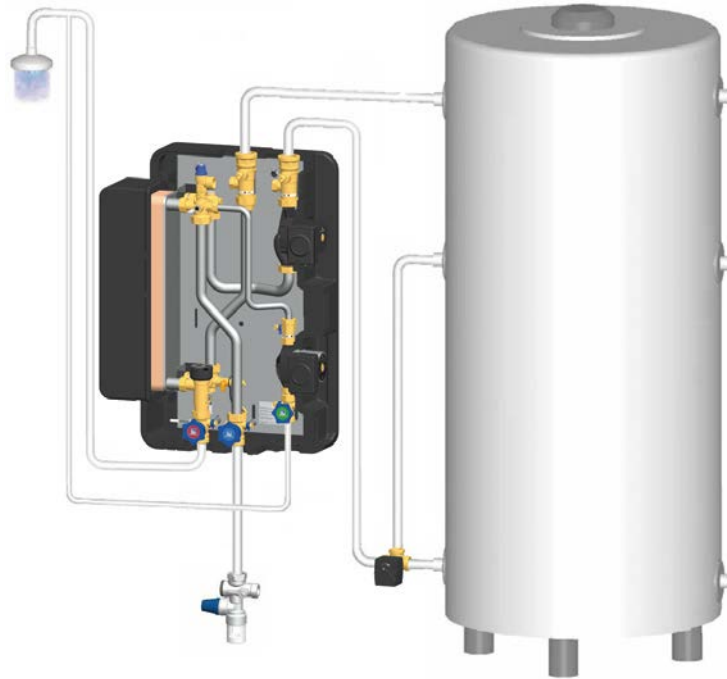

En caso de una instalación del módulo FriwaMidi o FriwaMaxi a la derecha del acumulador:
Cambie el sentido de rotación del accionador (véase el manual por separado del accionador).

Prioridad primaria (accionador desactivado)

Prioridad secundaria (accionador activado)



Posición 0

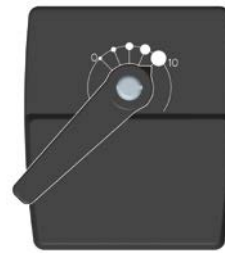

Posición 10

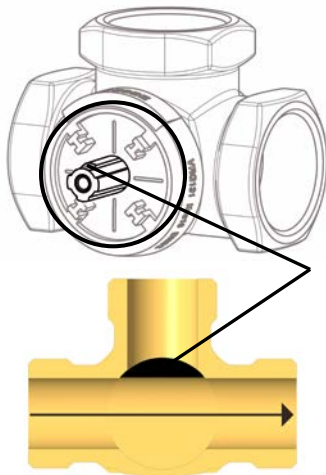

¡Observe la posición
de la nariz!

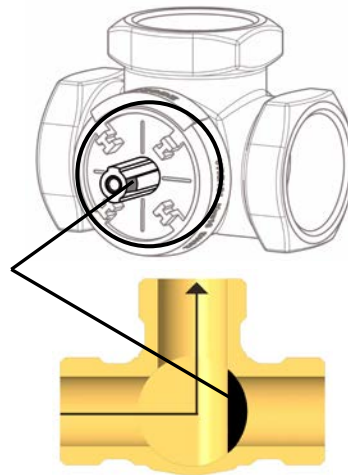

5 Esquema de cableado

El esquema de cableado describe cómo debe cablear la válvula de tres vías con el regulador.

Conexión al regulador	640423 / 640425	640424 / 6404242 / 6404244
Fase de red ($L_{const.}$)	marrón	marrón
Conductor neutro (N)	azul	azul
Conmutación (en R2)	negro	blanco
---	rojo: libre	---

5.1 Ejemplo: 640425 al FriwaMidi con regulador FC3.8

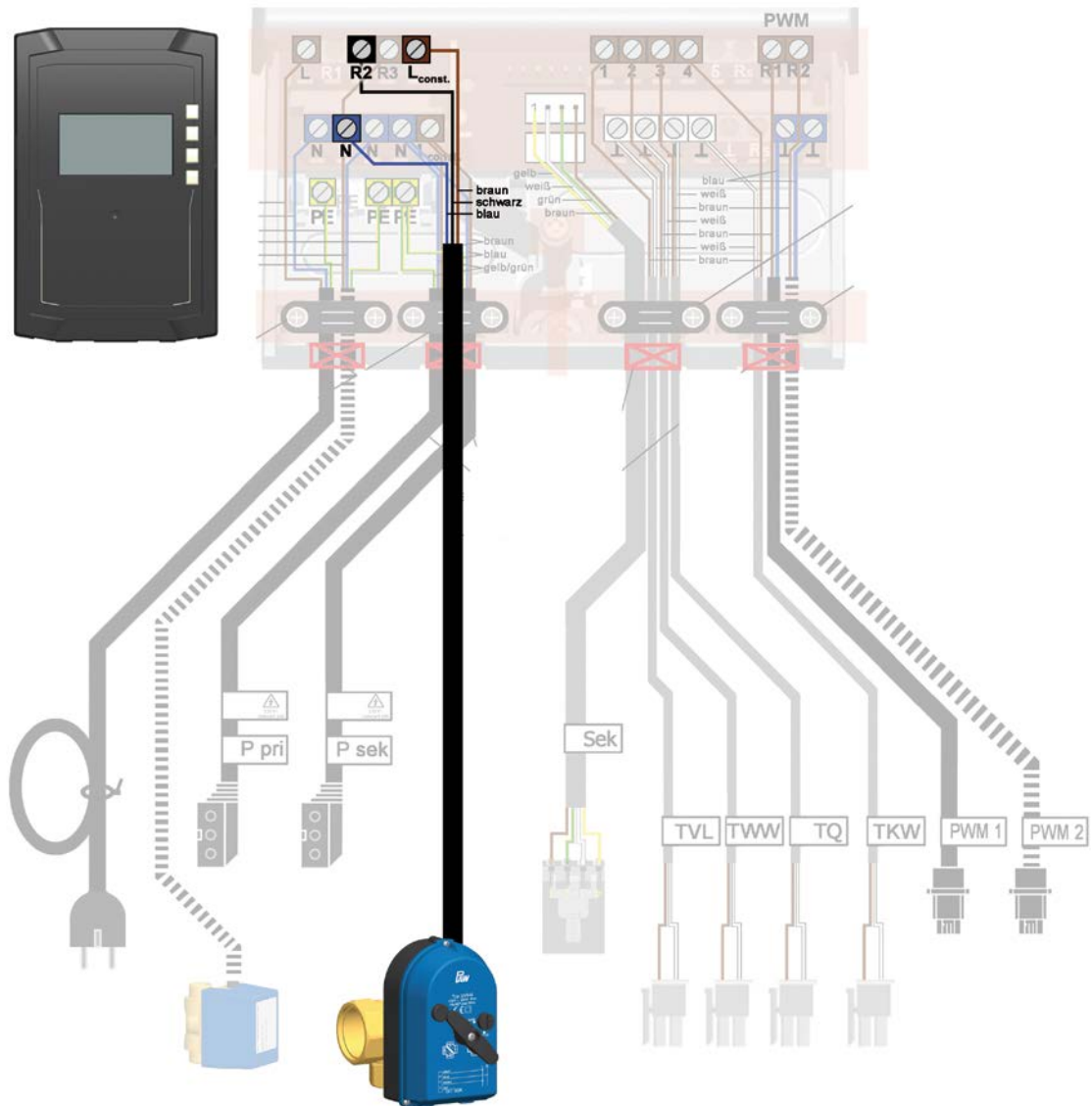

5.2 Ejemplo: 640424 al FriwaMaxi con regulador FC4.13

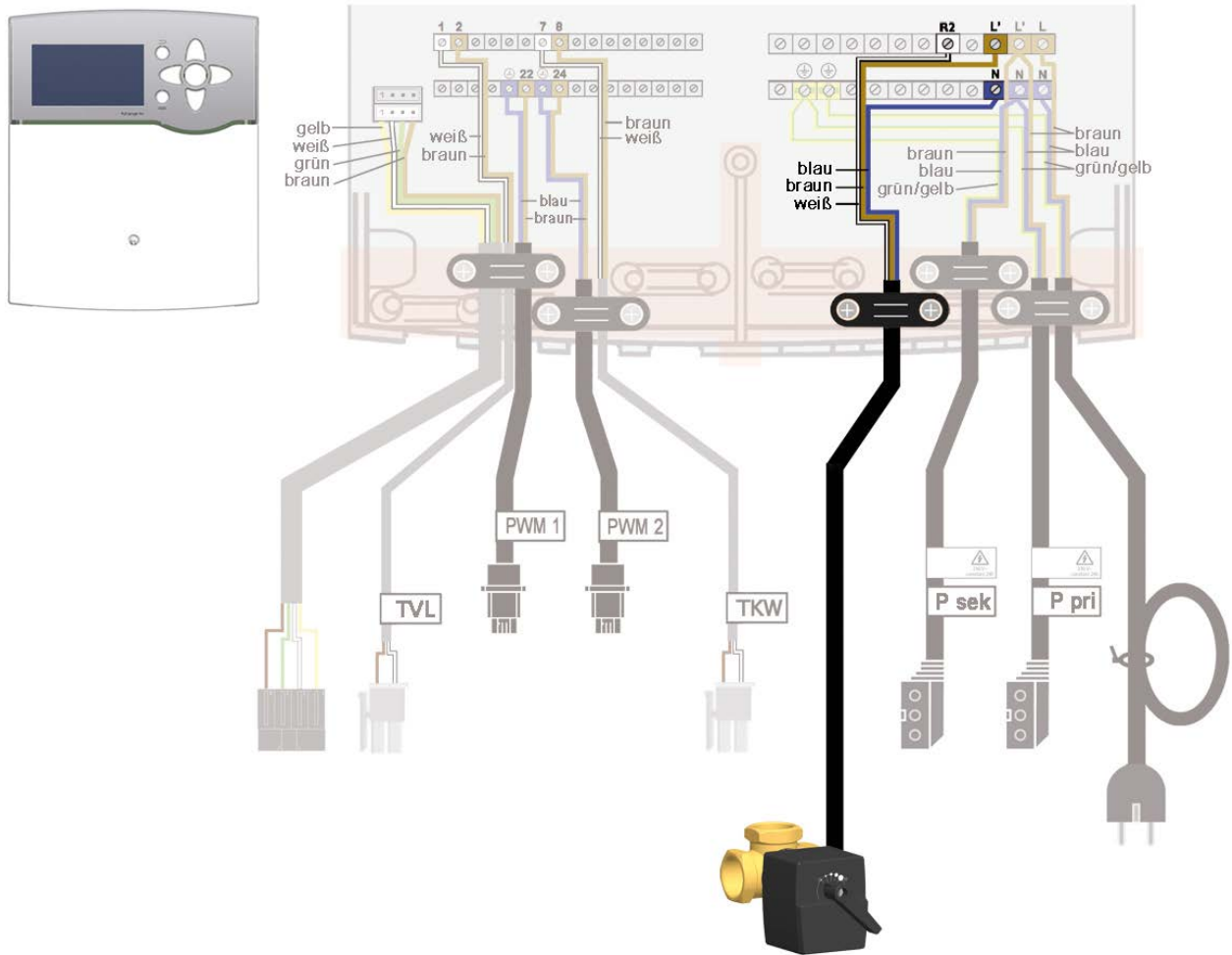

6 Ajuste del regulador

6.1 Ajuste del FC3.8

Active la función **"Válvula de distribución del retorno"** en el regulador. ¡Tenga en cuenta las instrucciones por separado del regulador!

Menú: Menú principal / Func / F:03 Válvula de distribución del retorno en "on"

6.2 Ajuste del FC4.13

Active la función **"Estratificación de retorno"** en el regulador. ¡Tenga en cuenta las instrucciones por separado del regulador!

Menú: Menú principal / Circulación / Estratif. retorno / Sí

Indice

1	Descrizione del prodotto	35
2	Avvertenze di sicurezza	36
3	Esempio di montaggio 640423 / 640425	37
4	Esempio di montaggio 640424 / 6404242 / 6404244	38
5	Schema di cablaggio.....	39
5.1	Esempio: 640425 al FriwaMidi con regolatore FC3.8	39
5.2	Esempio: 640424 al FriwaMaxi con regolatore FC4.13	40
6	Impostazione regolatore	41
6.1	Impostazione FC3.8.....	41
6.2	Impostazione FC4.13.....	41

Art. Nr. / Item no. / N° d'article / N° de art. / Nr. Art. 9964042x-mub-ml

Version / Versión / Versione V02

Technische Änderungen vorbehalten!

We reserve the right to make technical changes without notice!

Sous réserve de modifications techniques !

¡Sujeto a modificaciones técnicas!

Con riserva di modifiche tecniche!

PAW GmbH & Co. KG

Böcklerstraße 11

D-31789 Hameln, Germania



Printed in Germany - Copyright by PAW GmbH & Co. KG

1 Descrizione del prodotto

Durante la fase di ricircolo del modulo per acqua potabile Friwa si generano temperature di ritorno relativamente elevate. Affinché l'acqua di ritorno non penetri nella parte inferiore dell'accumulatore, qui mescolandosi con l'acqua fredda, mediante il set di distribuzione del ritorno Friwa è possibile stratificare l'acqua calda nella parte superiore dell'accumulatore.

Il set di distribuzione del ritorno comprende una valvola a tre vie con azionamento motorizzato (a seconda delle dimensioni).

Queste istruzioni valgono per gli articoli seguenti:



Set distribuzione ritorno	Codice articolo	
FriwaMini	640425	
FriwaMidi	640423	
FriwaMaxi	640424	
FriwaMidi-Kaskade FriwaMaxi-Kaskade	6404242	
FriwaMega-Kaskade	6404244	

2 Avvertenze di sicurezza

L'installazione, la messa in funzione nonché l'allacciamento dei componenti elettrici presuppongono conoscenze specialistiche, corrispondenti a un diploma di qualifica professionale riconosciuto, come impiantista termotecnico per impianti sanitari, di riscaldamento e di condizionamento ovvero a una professione con pari livello di conoscenze [esperto].

Durante l'installazione e la messa in funzione deve essere osservato quanto segue:

- normative regionali e sovraregionali rilevanti
- norme antinfortunistiche dell'Istituto di assicurazione contro gli infortuni sul lavoro
- indicazioni e avvertenze per la sicurezza delle presenti istruzioni per l'uso

	 AVVERTENZA
	<p>Pericolo di morte: scosse elettriche!</p> <ul style="list-style-type: none"> ➤ Staccare la spina prima di iniziare i lavori elettrici sul regolatore! ➤ Inserire la spina di rete del regolatore nella presa solo dopo aver concluso tutti i lavori di installazione. In questo modo si evita un avvio involontario dei motori.

3 Esempio di montaggio 640423 / 640425

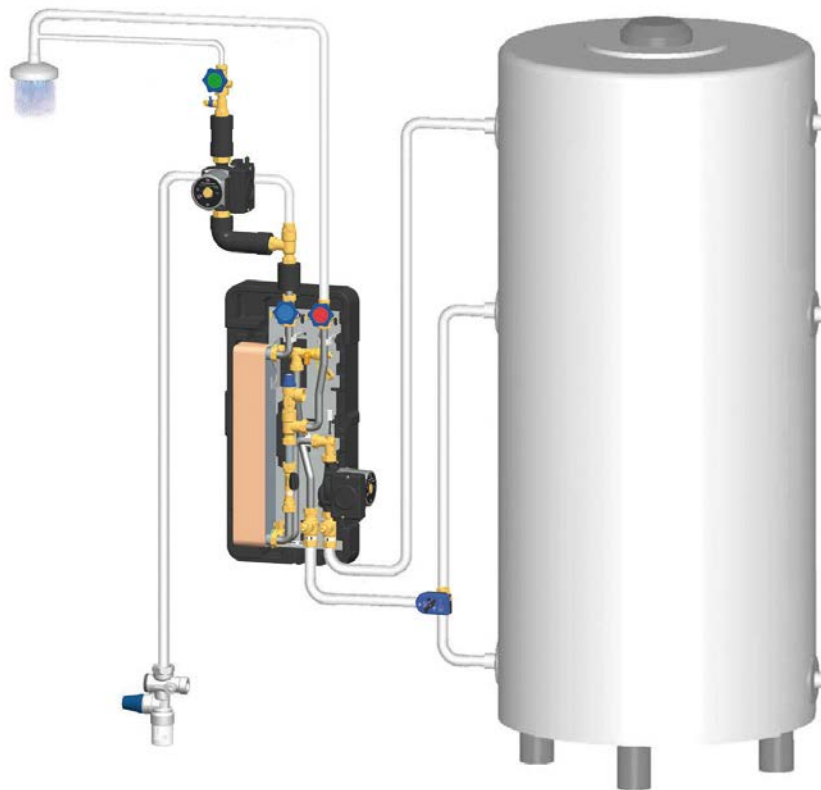

Con il modulo ACS istantanea FriwaMini o FriwaMidi a destra dell'accumulatore:
Cambiare la direzione di flusso della valvola di commutazione (vedi istruzioni a parte della valvola di commutazione).

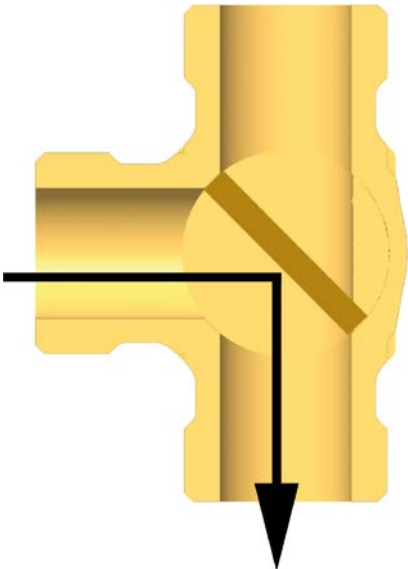
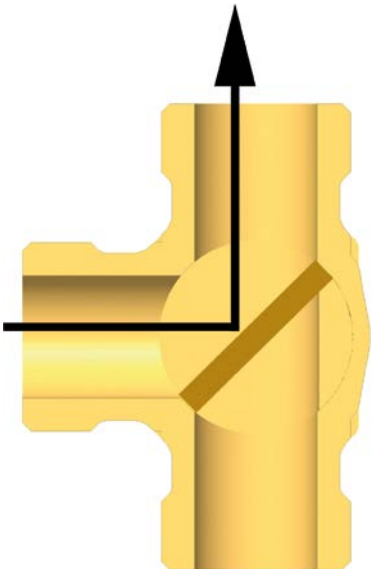
<p>Priorità primaria (motore in assenza di corrente)</p>	<p>Priorità secondaria (motore attivato)</p>
	

4 Esempio di montaggio 640424 / 6404242 / 6404244

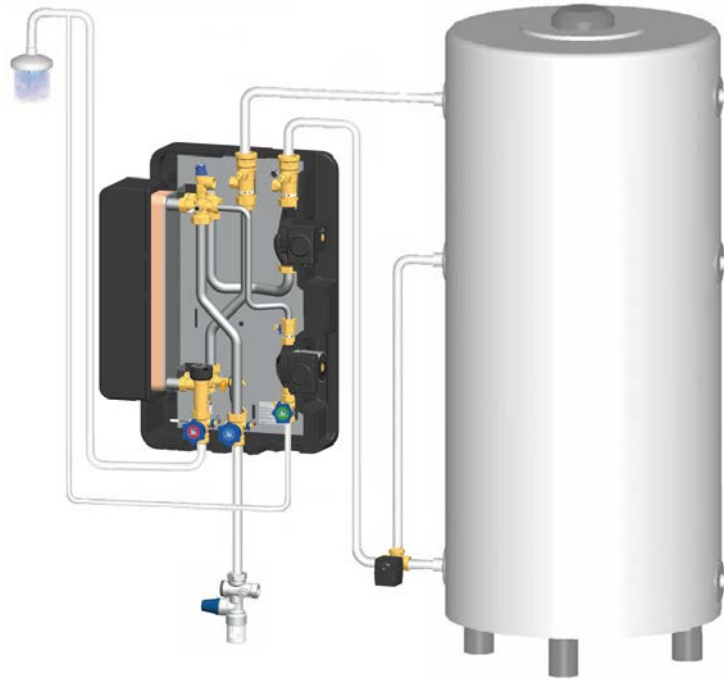

Con il modulo ACS istantanea FriwaMidi o FriwaMaxi a destra dell'accumulatore:
Cambiare la direzione di rotazione del servomotore (vedi istruzioni a parte del servomotore).

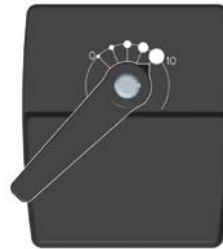
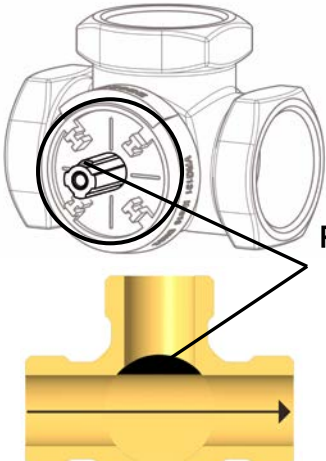
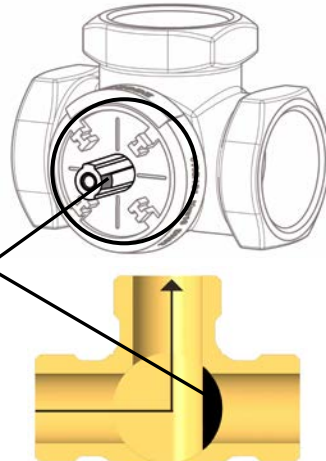
Priorità primaria (motore in assenza di corrente)	Priorità secondaria (motore attivato)
 <p data-bbox="383 1523 542 1568">Posizione 0</p>	 <p data-bbox="1037 1523 1197 1568">Posizione 10</p>
	

Prestare attenzione alla posizione del nasello!

5 Schema di cablaggio

Nello schema di collegamento sotto riportato viene illustrato il modo in cui la valvola a tre vie deve essere cablata con il sistema di regolazione.

Collegamento al regolatore	640423 / 640425	640424 / 6404242 / 6404244
Fase in rete ($L_{const.}$)	marrone	marrone
Neutro (N)	blu	blu
Fase d'inserzione (su R2)	nero	bianco
---	rosso: non utilizzato	---

5.1 Esempio: 640425 al FriwaMidi con regolatore FC3.8

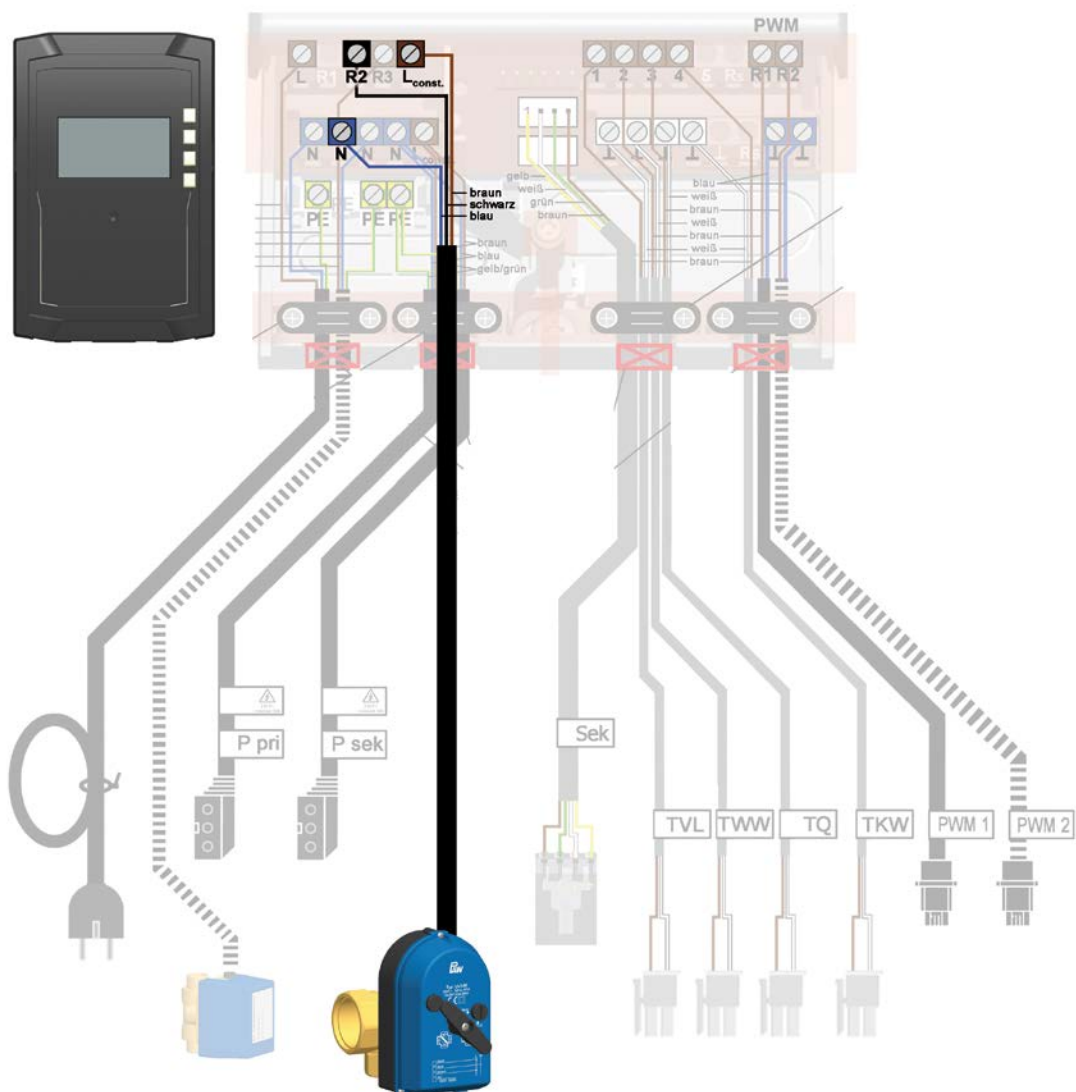

5.2 Esempio: 640424 al FriwaMaxi con regolatore FC4.13

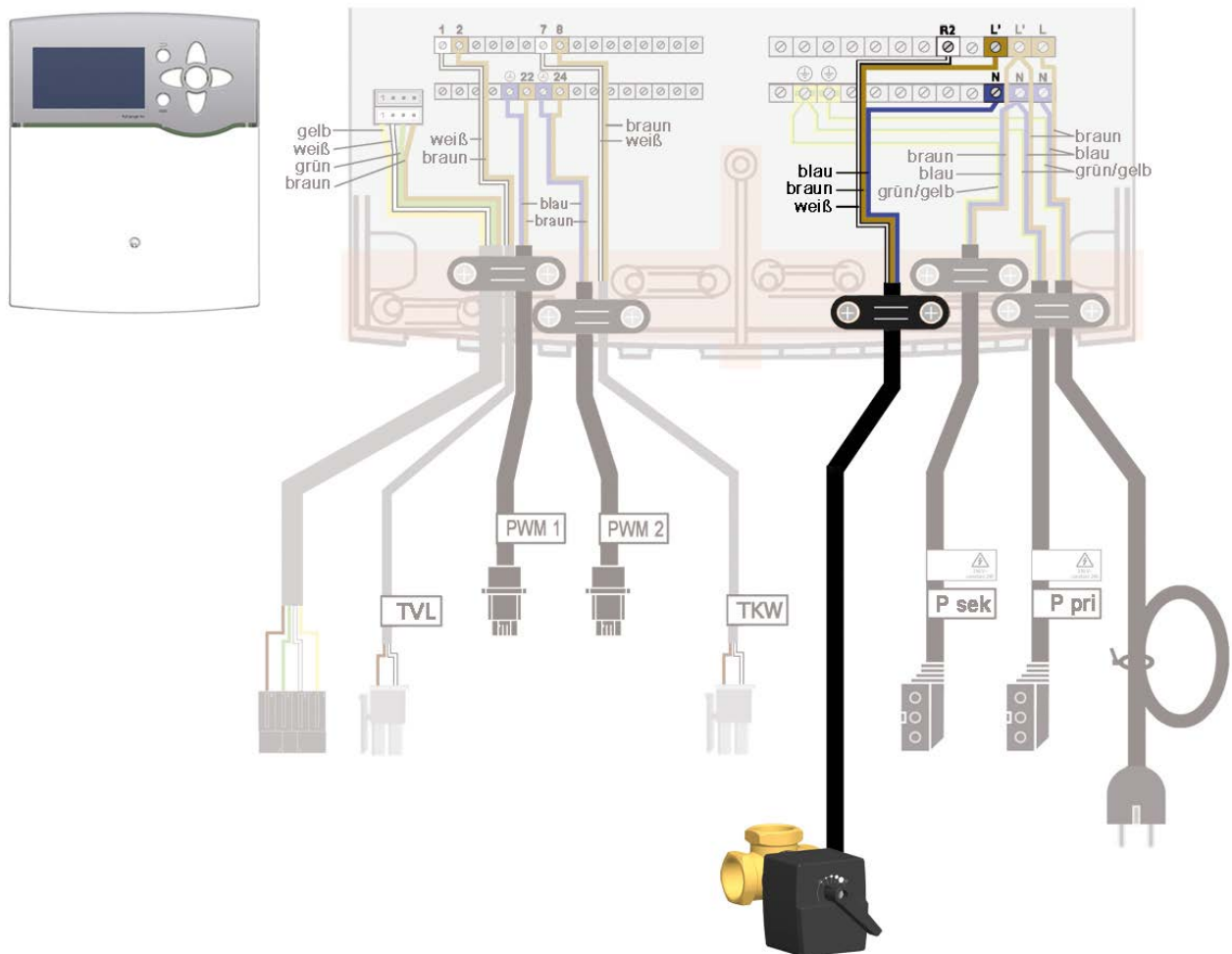

6 Impostazione regolatore

6.1 Impostazione FC3.8

Attivare la funzione **"Valvola di distribuzione nel ritorno"** nel regolatore. Attenersi alle istruzioni separate del regolatore!

Menu: Menu principale / Func / F:03 Valvola di distribuzione nel ritorno su "on"

6.2 Impostazione FC4.13

Attivare la funzione **"Stratificazione ritorno"** nel regolatore. Attenersi alle istruzioni separate del regolatore!

Menu: Menu principale / Circolazione / Stratif. ritorno /Sì

PAW GmbH & Co. KG
Böcklerstraße 11
D-31789 Hameln, Germany

www.paw.eu
Phone: +49 (0) 5151 9856 - 0
Fax: +49 (0) 5151 985698