



Installation and Operation Instructions Controller FC3.10 for DHW modules

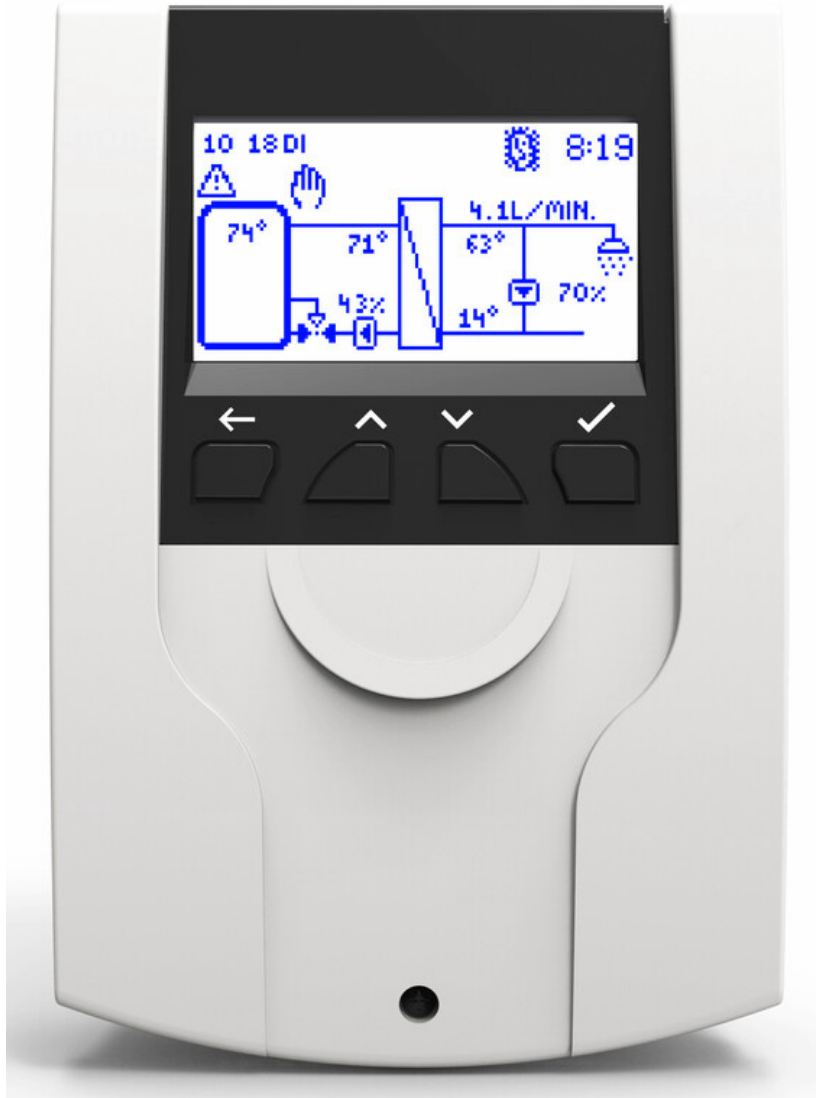

Table of Contents

1	General Information.....	6
1.1	Scope of these instructions.....	6
1.2	Designated use.....	6
1.3	Target group.....	6
2	Safety instructions.....	7
3	Mounting and installation [specialist].....	8
3.1	Installation of the controller.....	8
3.2	Establishing the electrical connections.....	11
4	Product description and operation.....	13
4.1	View of the controller.....	13
4.2	Operating buttons / key combination.....	13
4.3	Display.....	14
4.4	Symbols.....	15
5	Commissioning [specialist].....	16
5.1	Language.....	16
5.2	Controller type.....	16
5.3	Date.....	17
5.4	Time.....	17
5.5	Automatic Daylight saving time / Standard time.....	17
5.6	Cascade*.....	17
5.7	Scan Modbus*.....	18
5.8	Nominal temperature.....	18
5.9	Functions.....	18
5.10	Finish with protocol.....	18
5.11	Finish without protocol.....	19
6	Menu settings.....	20
7	Status.....	22
7.1	Measured and balance values.....	22
7.2	Reports.....	23

7.3	Service.....	23
7.4	Controller.....	24
8	Hot water.....	25
9	Functions.....	26
10	General settings.....	27
10.1	Language.....	27
10.2	Date.....	27
10.3	Time.....	27
10.4	Date / time.....	27
10.5	Automatic Daylight saving time / Standard time.....	27
10.6	Commissioning*.....	27
10.7	Software update.....	27
10.8	Display.....	28
11	Internet module.....	29
11.1	Registration.....	29
11.2	Set up the network.....	29
11.3	Information.....	29
12	Modbus settings*.....	30
13	USB.....	31
13.1	Eject memory.....	31
13.2	Load settings.....	31
13.3	Save settings.....	31
13.4	Save alarm history.....	31
13.5	Save parameter history.....	32
13.6	Data logging interval.....	32
13.7	Recording type.....	32
13.8	Format data carrier.....	32
13.9	Properties.....	33
14	Automatic/manual mode.....	34
15	User code.....	36

16	Advanced settings.....	37
16.1	Remote control / write protection.....	37
16.2	Minimum speed*.....	38
17	Description of function.....	39
17.1	Circulation.....	39
17.2	Stratification (return stratification).....	43
17.3	Modulating hot water temperature.....	44
17.4	Comfort function.....	45
17.5	Disinfection.....	46
17.6	Alarm relay.....	48
17.7	Parallel relay.....	49
17.8	Hygienic flush / protection against blocking.....	50
17.9	Buffer tank*.....	50
17.10	Reheating*.....	51
18	Installation of the cascade controller.....	52
18.1	Installation.....	53
18.2	Initial commissioning of the cascade controller.....	57
18.3	Extension of a single controller to a cascade network.....	59
19	Menu settings cascade.....	60
20	Submenu Cascade at the client.....	62
20.1	Cascade switchover points.....	62
20.2	Switchover point ON*.....	62
20.3	Switchover point OFF*.....	63
20.4	Switchover delay*.....	63
20.5	Duration of standby module*.....	63
20.6	Synchronise*.....	63
21	Submenus at the server.....	65
21.1	Status.....	65
21.2	General settings.....	65
21.3	USB.....	65

21.4	Automatic / manual mode.....	65
22	Functions in the cascade network.....	66
22.1	Circulation.....	66
22.2	Stratification return.....	67
22.3	Comfort function.....	68
22.4	Thermal disinfection.....	68
22.5	Alarm relay.....	69
22.6	Parallel relay.....	69
22.7	Hygienic flush / protection against blocking.....	69
22.8	Buffer tank.....	69
22.9	Post-heating.....	69
23	Connection to Building Management System.....	70
23.1	Single domestic hot water module.....	70
23.2	Cascade.....	71
23.3	List of the Modbus registers.....	73
24	Technical data.....	74
25	Error correction.....	76
25.1	Error messages.....	76
25.2	Troubleshooting.....	78
25.3	Checking the VFS 2-40 flow sensor.....	81
25.4	Checking the FlowSonic flow sensor.....	82
26	Disposal.....	84
27	Exclusion of liability.....	85
28	Legal guarantee.....	86

1 General Information



Carefully read these instructions before installation and commissioning.

Save these instructions in the vicinity of the installation for future reference.

1.1 Scope of these instructions

These instructions describe the function, installation and commissioning of the DHW controller FC3.10. The chapters called [specialist] are intended for specialists only. For further components external of the module, such as valves, please follow the instructions of the respective manufacturer.

1.2 Designated use

The domestic hot water controller, subsequently referred to as the controller, is an independently installed electronic temperature controller for on-surface installation. The maintenance-free controller is exclusively intended for the controlling and monitoring of a PAW domestic hot water module. Improper usage of the controller excludes any liability claims.

This product complies with the relevant directives and is therefore labelled with the CE mark. The Declaration of Conformity is available upon request, please contact the manufacturer.

Only use PAW accessories with the controller.

1.3 Target group

The target audience of this manual are technical professionals who:

- have the knowledge of terminology and the skills necessary for setting up and operating domestic hot water modules.
- have the necessary professional training, knowledge and experience as well as the knowledge of the relevant regulations, in order to evaluate the following work and to detect potential dangers:
 - Installation of electrical devices
 - Assembly and connection of data lines
 - Assembly and connection of power supply lines.

2 Safety instructions

The installation and commissioning as well as the connection of electrical components require technical knowledge commensurate with a recognised vocational qualification as a fitter for plumbing, heating and air conditioning technology, or a profession requiring a comparable level of knowledge [specialist].

The following must be observed during installation and commissioning:

- relevant local and national regulations
- accident prevention regulations of the professional association
- instructions and safety instructions mentioned in these instructions

WARNING

Personal injury and damage to property!

The controller must only be used in domestic hot water modules. The domestic hot water module can be damaged by improper operation of the device. The device must not be connected to the mains power supply when:

- ▶ the housing is open or damaged.
- ▶ cables are damaged.

This document is part of the product. Install and use the device only after having read and understood this document. Please observe all safety instructions. Please contact an additional expert if uncertainties occur.

The measures described in this document may only be carried out by qualified technical professionals. Factory labels and markings must never be modified, removed or rendered unreadable. Observe the prescribed operating conditions. For more information, see the section *Technical data*. This device is **not** intended for:

- Children
- Persons with restricted physical, sensory or mental capacities.
- Persons without sufficient experience or knowledge. Unless they are instructed in the use of the device, and initially supervised, by a person responsible for their safety.

3 Mounting and installation [specialist]

3.1 Installation of the controller

NOTICE

The following section describes only the installation of the controller. Follow the instructions of each respective manufacturer when installing external components (valves etc.)

Do not put the controller into operation in case of any visible damage.

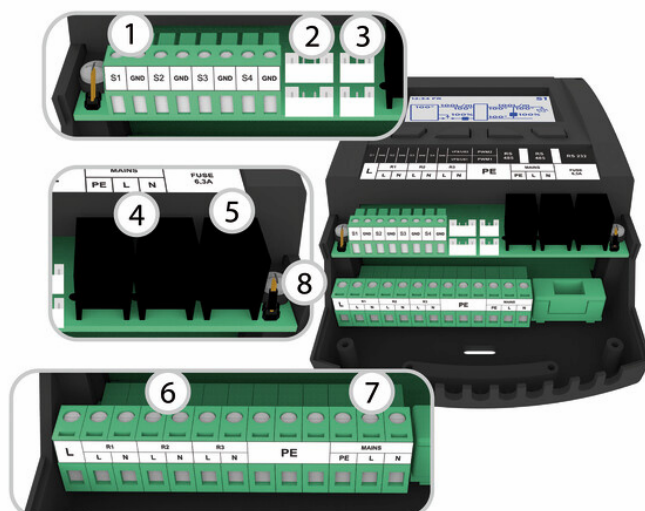
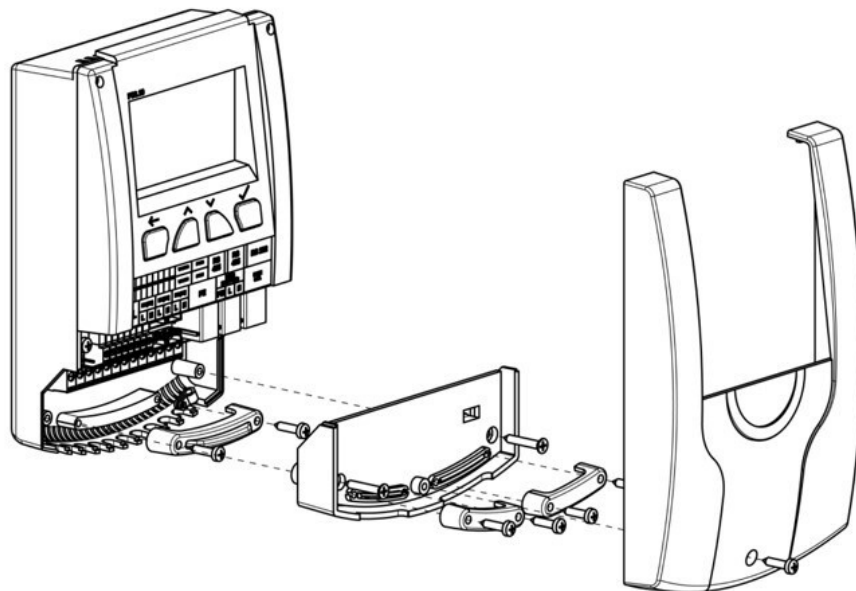

1. Temperature sensors S1-S4 (Pt1000)
2. Flow sensors (VFS/US)
3. Outputs PWM
4. Modbus (RS 485)
5. RS 232
6. Outputs 230 V
7. Supply
8. Position of the jumper
9. Fuse

WARNING



Risk to life and limb due to electric shock!

- ▶ Disconnect the controller from the power supply before opening the body.
- ▶ Make sure that the power supply cannot be unintentionally switched on when the body is open.

Inputs FriwaMini:

Terminal	Individual operation mode / Cascade operation mode
S1, L	Flow temperature, primary (T-FL)
S2, L	Optional: Storage tank temperature (T-ST), ext. circulation temperature, ext. return stratification temperature
S3, L	Optional: Storage tank temperature (T-ST), ext. circulation temperature, ext. return stratification temperature
S4, L	Cold water temperature, secondary (T-CW)
VFS/US1	Domestic hot water temperature (T-DHW) and flow rate, secondary

Inputs FriwaMidi/Maxi/Mega:

Terminal	Individual operation mode / Cascade operation mode
S1, L	Flow temperature, primary (T-FL)
S2, L	Domestic hot water temperature, secondary (T-DHW)
S3, L	Optional: Storage tank temperature (T-ST), ext. circulation temperature, ext. return stratification temperature
S4, L	Cold water temperature, secondary (T-CW)
VFS/US1	Flow rate, secondary
VFS/US2	(for FriwaMega): flow rate, secondary

Outputs:

Terminal	Individual operation	Cascade operation mode
R1	Optional: alarm relay, error relay, reheating, return stratification	Cascade valve
R2	Optional: return stratification, alarm relay, error relay, reheating	Return stratification (Connection at server 1)
R3	Primary- / secondary pump	Primary- / secondary pump
PWM1	Primary pump	Primary pump
PWM2	Secondary pump (circulation)	

3.2 Establishing the electrical connections

WARNING	
	<p>Risk to life and limb due to electric shock!</p> <p>Make sure that the following conditions are satisfied when performing the work described in this section:</p> <ul style="list-style-type: none"> ▶ All cables leading to the controller must be disconnected from the power supply and it must be ensured that they cannot be unintentionally reconnected during installation. ▶ The protective earth conductors (PE) from the mains cable and pump and valve cables must be connected to the protective earth conductor terminal block. ▶ All cables must be laid so that persons cannot stand on them or trip over them. ▶ The cables must satisfy the requirements listed in the <i>Technical data</i> section. ▶ The local power supply must match the specifications on the type plate of the controller. ▶ The power supply cable is to be connected to the mains power as follows: <ul style="list-style-type: none"> ● Using a plug connected to a wall mains socket or ● via an isolating mechanism allowing complete isolation in the case of permanent wiring. ▶ The power supply cable must be laid according to all applicable legal guidelines and regulations of the local electricity supplier.

CAUTION
Danger of damage and malfunction!

Connect only components that do not overload the controller inputs and outputs; more information is provided on the type plate and in the *Technical data* section.

When using a circulation pump, especially with the FriwaMega, the power consumption of the pump connected to the controller must absolutely be observed and it has to be checked whether they are compatible with the controller. In some cases the circulation pump directly has to be supplied by the mains connection. The speed is controlled via the PWM signal.

NOTICE

- ▶ Any connection polarity may be used for the 1 – 4 signal inputs and outputs.
- ▶ Only type Pt1000 temperature sensors may be used.
- ▶ Lay the sensor cables at least 100 mm away from any power supply cables.
- ▶ Use shielded sensor cables when inductive sources are present, e.g. high-voltage lines, radio transmitters, microwave devices.

4 Product description and operation

4.1 View of the controller

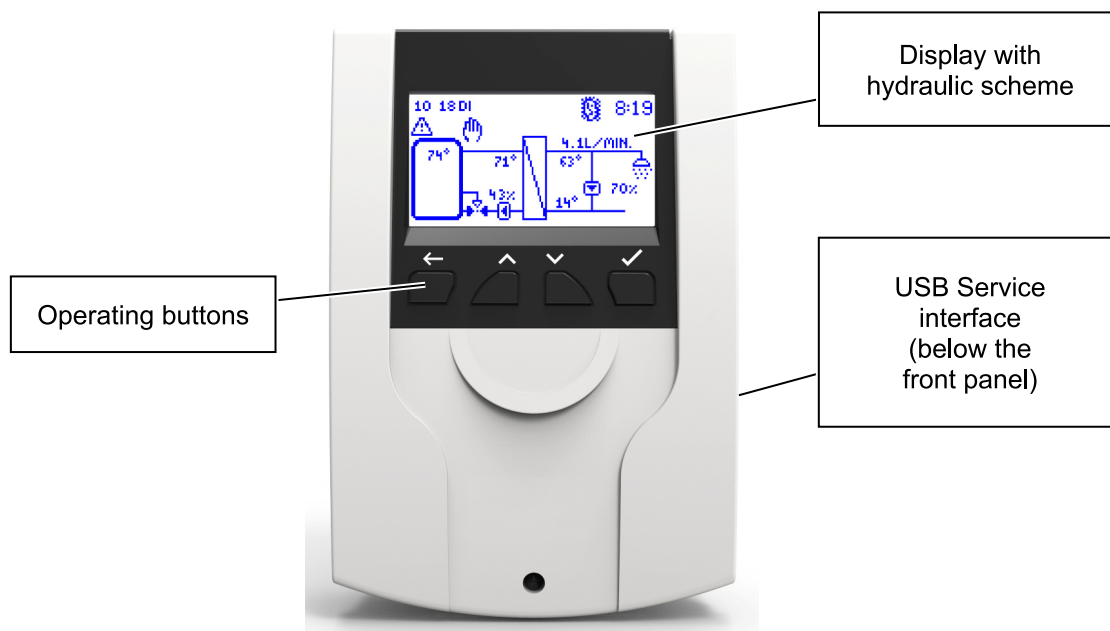

4.2 Operating buttons / key combination

Button	Description
	Back: goes back to the next higher level or back to the system overview
	Upwards: navigates upwards in the menu, increases adjustment values
	Downwards: navigates downwards in the menu, decreases adjustment values
	Confirm: opens the main menu, goes to the next lower level, confirms set values, activates functions

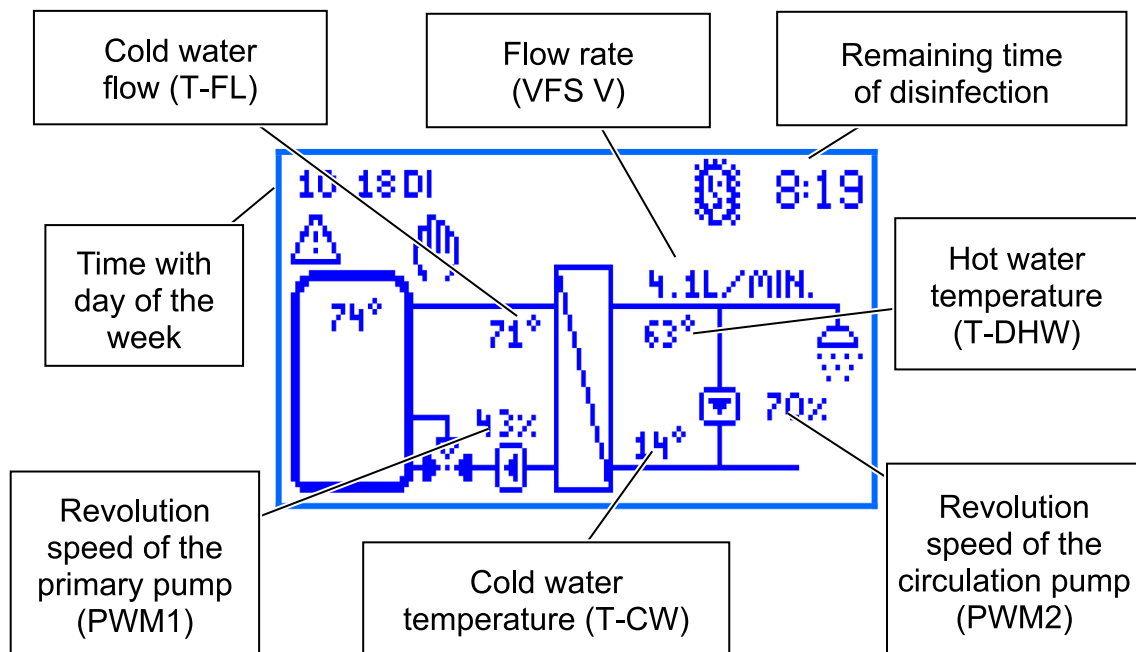

Key combination	Description
Standby on	Keep buttons Back and Confirm pressed
Standby off	Keep button Back pressed for 5 s
Factory settings	Keep button Confirm pressed for 30 s
Software update	Keep buttons Upwards and downwards pressed for 5 s (USB flash drive with firmware version connected)

4.3 Display



4 Product description and operation

4.4 Symbols

Symbol	Description
	Three-way valve with flow direction
	Check box (activated/deactivated)
	Disinfection active
	Error message
	Manual mode
	Pump
	Storage tank
	Thermometer
	Heat exchanger
	Modulating hot water temperature active
	Water withdrawal point
	USB record active
	Write protection for remote control via WiFi module, BMS, Modbus Gateway
	Modbus communication active
SYNC	Synchronisation of the parameters within the cascade

5 Commissioning [specialist]

DANGER	
	<p>Risk to life and limb due to electric shock!</p> <ul style="list-style-type: none"> ▶ Be sure to perform all the measures listed in the section <i>Mounting and installation</i> before starting the first commissioning.

If the controller is connected for the first time, the message "**Please carry out the first start-up**" is displayed on the screen.

After confirming with "**Yes**", the commissioning menu is displayed where you can successively make the desired general settings.

5.1 Language



Set the desired menu language.

5.2 Controller type

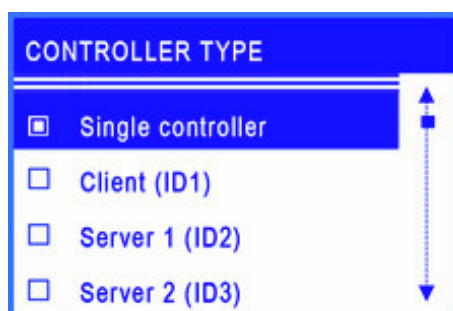

Set the available type of controller. The menu item Single controller should be selected if you want to put into operation only one domestic hot water module.

If you connect multiple domestic hot water modules (2 - 4 modules) hydraulically in parallel, these controllers are called cascading. The controllers are connected via a bus line with each other and are called *Client* or *server*.

5.3 Date



The screenshot shows a blue-bordered menu titled "SET DATE". The date "17 - 03 - 2020" is displayed in the center. The number "17" is highlighted with a blue background. At the bottom of the menu, the word "Day" is displayed in white text on a blue background.

Set the current date. First set the day, the month and finally the year.

5.4 Time

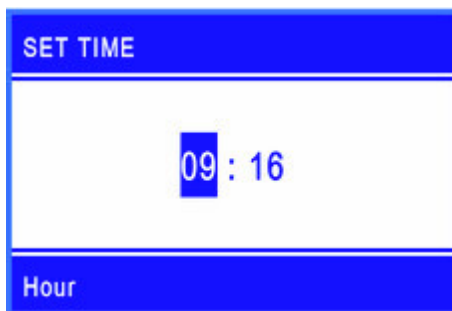

The screenshot shows a blue-bordered menu titled "SET TIME". The time "09 : 16" is displayed in the center. The number "09" is highlighted with a blue background. At the bottom of the menu, the word "Hour" is displayed in white text on a blue background.

Set the current time. First set the hours, then the minutes.

5.5 Automatic Daylight saving time / Standard time

Activate/deactivate the automatic daylight saving time / standard time.

When the controller is delivered, this item is activated.

5.6 Cascade*

At this menu item, the operating parameters (switchover point, duration of backup mode) of the domestic hot water modules within a cascade are set.

5.7 Scan Modbus*

SCAN MODBUS	STATUS
Server 1	OK
Server 2	---
Server 3	---
MB3.10	---

The identification of the domestic hot water modules which are operated in the cascade mode is made via the menu item *Scan Modbus*.

The dot marks which controller type is searched at the moment.

*This submenu appears if the client (ID1) was selected at "Controller type".

5.8 Nominal temperature

NOMINAL TEMPERATURE	
60 °C	
MIN : 35	MAX : 75

Setting the desired nominal temperature of the hot water.

5.9 Functions

Activate/deactivate the functions and further, corresponding settings. When the domestic hot water module is delivered, as well as after a reset to factory settings, all functions are deactivated apart from *Over temperature switch off*.

You will find detailed information on this in chapter 17.

5.10 Finish with protocol

Save the commissioning with creating a protocol. For this, an external memory (USB flash drive) must be connected to the service interface / USB port. This interface can only be accessed after removal of the front panel, see chapter 4.1.

5 Commissioning [specialist]

5.11 Finish without protocol

Completes the commissioning without a further saving on an external USB flash drive. The settings made during the commissioning can be changed at any time in the corresponding sub menus. After the commissioning is completed, the controller is ready for use.

Parameters	Description	Adjustment range	Factory setting
Language	Selection of the menu language	German, English, French, Spanish, Italian, Dutch, Polish, Swedish	German
Controller type	Setting the type of controller	Single controller, client, server 1, server 2, server 3, MB3.10, deactivated	Single controller
Date	Setting the date	-	-
Time	Setting the time	-	-
Autom. Daylight saving time/standard time	Activate the automatic change to daylight saving time/standard time	Yes, No	Yes
Cascade	Operating parameters of the cascade	-	-
Scan Modbus	Identification of the modules	-	-
Nominal temperature	Setting the hot water nominal temperature	35 ... 75 °C	60 °C
Functions	Submenu of the functions	-	-
Finish with protocol	Save with protocol	-	-
Finish without protocol	Save without protocol	-	-

6 Menu settings

By pressing the operating button "**Confirm**" the menu of the controller FC3.10 opens. The menu bar contains multiple submenus in which you can find or modify various settings. The available menu items of the first three levels are shown as a menu tree and will be explained in detail in the following chapters.

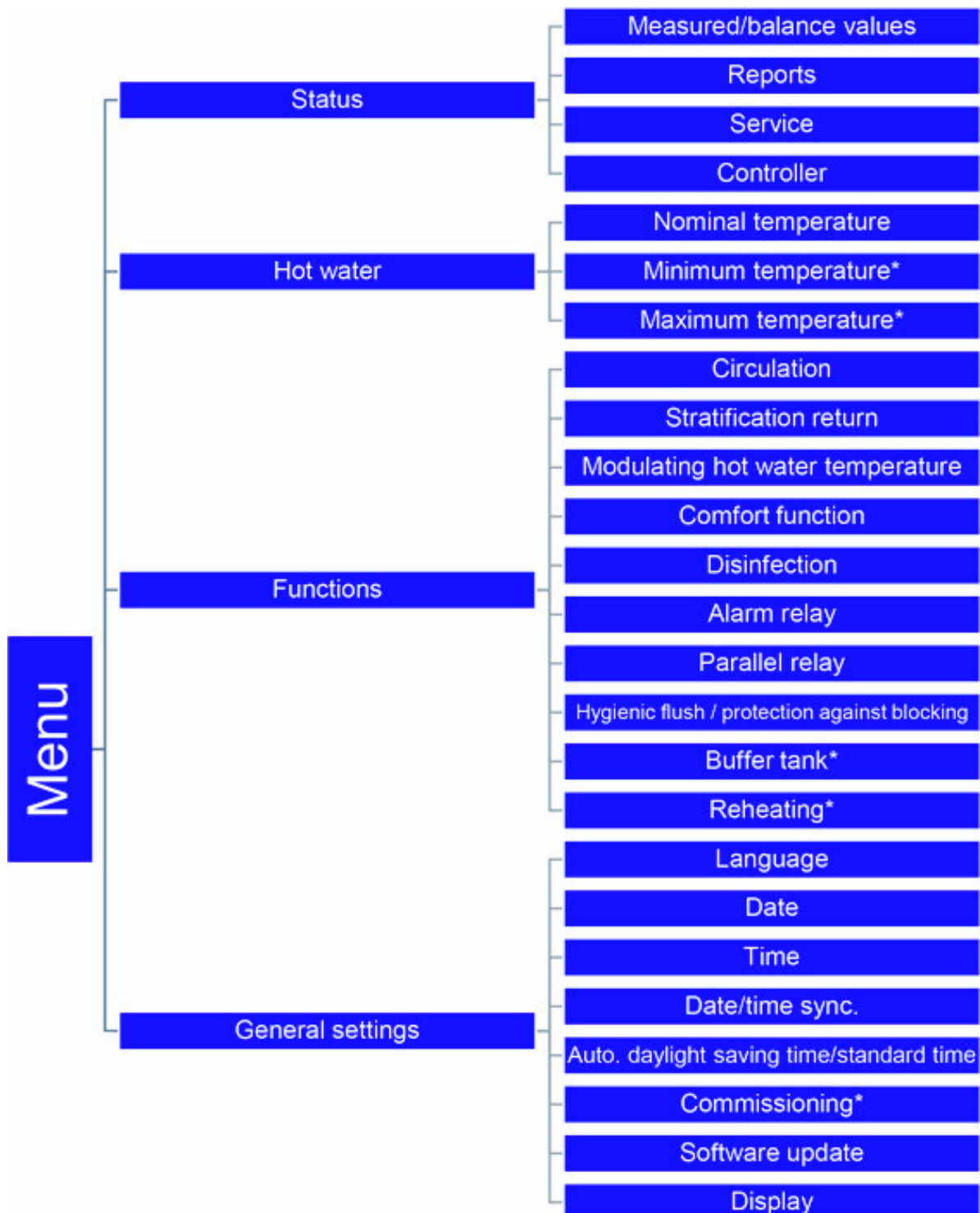



*Settings only visible with installer code (see chapter "User code").

7 Status

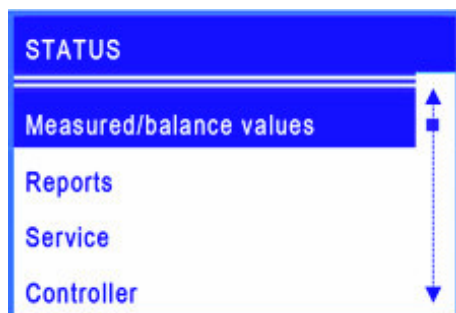

The menu item *Status* contains submenus which allow to look through all measured/balance values, temperatures and flow rates at the sensors, relay states, operating times, heat quantity, tap performance as well as error messages. In addition, the current firmware is displayed at the item *Controller*.

7.1 Measured and balance values

SENSORS		1/2	
	CURR.	MIN:	MAX:
Sensor S1 °C	79.4	78.9	80.6
Sensor S2 °C	--	--	--
Sensor S3 °C	--	--	--
Sensor S4 °C	9.8	8.2	13.4

This menu item contains the information of all current measured values of the sensors, their minimum and maximum measured values as well as the states of the relays (R1, R2, R3).

The minimum and maximum measured values can be reset by pressing the operating button *Confirm*.

OPERATING TIME			
Relay 1	0D	07H	01M
Relay 2	0D	00H	00M
Relay 3	0D	00H	00M
Pump 1	0D	07H	00M
Pump 2	0D	00H	00M

In addition, the current operating times, the cycles of operation, the heat quantity and the tap performance are recorded and are displayed in the corresponding submenus. An example is shown in the illustration.

The heat quantity and the tap performance are shown in the following periods of time:

- Current value
- Day (is reset at 00:00 a.m.)
- Week (is reset each Monday at 00:00 a.m.)
- Month (is reset at the first day of the month at 00:00 a.m.)
- Total

In addition, you can reset the data of the periods of time via the *Confirm* button.

7.2 Reports

This menu item displays the occurring errors which the controller diagnosed.



If an error occurs, the displays show a symbol, also an error message with information about the error is shown.

In the illustration on the left side, an example of an alarm message is shown.

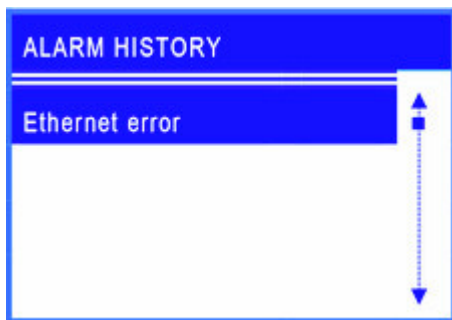

In this submenu item, the history of the occurred error messages can be repeatedly displayed. Also, you can receive more information about the corresponding error such as the date and the time. When they occur, error messages are confirmed with the operating button *Back*.

7.3 Service

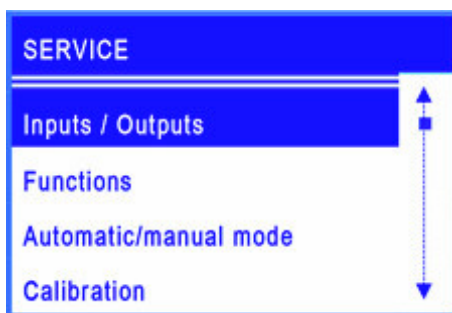

In this menu item, the assignment of all inputs and outputs is displayed.

In addition, it is shown which functions are active/inactive and which relays and sensors are actuated via the automatic/manual mode.

7.4 Controller

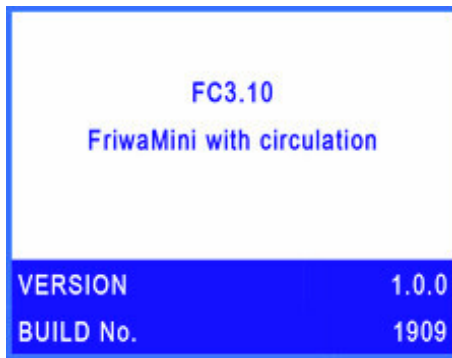

The screenshot shows a digital display with a white background and a blue border. At the top, the text 'FC3.10' is displayed in blue, followed by 'FriwaMini with circulation' in a smaller blue font. Below this, there is a blue horizontal bar containing the text 'VERSION 1.0.0' and 'BUILD No. 1909' in white.

FC3.10	
FriwaMini with circulation	
VERSION	1.0.0
BUILD No.	1909

Display of the current software version and the domestic hot water module which was selected during commissioning.

8 Hot water

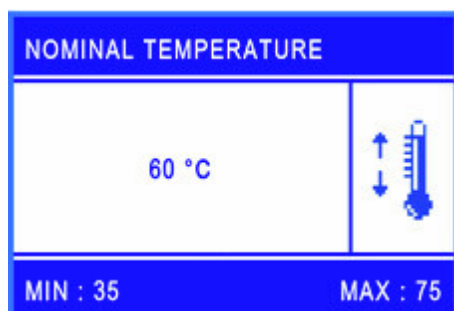

In this menu item, you can make the temperature settings for the hot water preparation.

Setting options for the following parameters are available:

- *Nominal temperature*: the set hot water temperature which is supposed to be reached at the outlet of the domestic hot water module.
- *Minimum temperature**: the lower limit for the setting of the hot water temperature.
- *Maximum temperature**: the upper limit for the setting of the hot water temperature.

Parameters	Description	Adjustment range	Factory setting
Nominal temperature	Hot water nominal temperature	35 ... 75 °C	60 °C
Minimum temperature*	Minimum hot water nominal temperature	20 ... 45 °C	35 °C
Maximum temperature*	Maximum hot water nominal temperature	60 ... 90 °C	75 °C

*Settings only visible with installer code (see chapter "User code").

9 Functions

This menu item contains all selectable functions as well as the corresponding settings. To activate/deactivate the desired functions, press the *Confirm* button. Then, the corresponding submenu opens. By pressing again the *Confirm* button, you can activate/deactivate the functions.

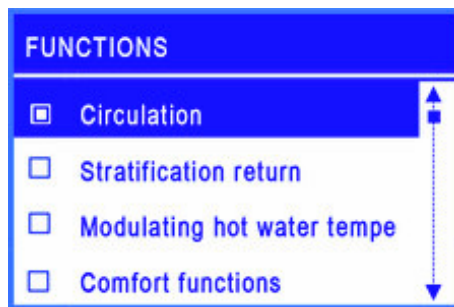

In the example, the ticked check box indicates that the function *Circulation* was activated.

The following functions are available:

- Circulation
- Stratification return
- Modulating hot water temperature
- Comfort function
- Disinfection
- Alarm relay
- Parallel relay
- Hygienic flush
- Buffer tank*
- Reheating*

Detailed information in chapter *Description of function*.

**Settings only visible with installer code (see chapter "User code").*

10 General settings

In this menu, you can make all basic settings of the controller as well as update/modify settings of the commissioning. The menu is structured as follows:

10.1 Language

Set the desired language (see "Commissioning")

10.2 Date

Set the current date. First set the day, the month and finally the year.

10.3 Time

Set the current time. First set the hours, then the minutes.

10.4 Date / time

Activate/deactivate the synchronisation of date and time. The synchronisation is only possible in connection with an internet module.

10.5 Automatic Daylight saving time / Standard time

Activate/deactivate the automatic daylight saving time / standard time.

When the controller is delivered, this menu item is activated.

10.6 Commissioning*

Opens the commissioning menu to go through the settings again.

**Settings only visible with installer code (see chapter "User code").*

10.7 Software update

To update the software, a USB flash drive with the new software on it must be connected to the USB port. After that, the update can be started via this menu item. This can take 5 minutes.

10.8 Display

The submenu contains all settings to adjust the display to your individual needs. Here you can adjust parameters like luminosity, contrast and inversion of colours. In addition to that, you can activate the screen lock.

After activating the screen lock, the screen is locked after a determined period and accessing the menu of the controller is only possible after entering the set PIN code.

Parameters	Description	Adjustment range	Factory setting
Language	Selection of the menu language	German, English, French, Spanish, Italian, Dutch, Polish, Swedish	German
Date	Setting the date	-	-
Time	Setting the time	-	-
Synchronise date/time	Synchronisation of the date/time (Internet module is required)	Yes, No	No
Autom. Daylight saving time/standard time	Activate the automatic change to daylight saving time/standard time	Yes, No	Yes
Commissioning*	Submenu of the commissioning	-	-
Software update	Start updating	-	-
Display	Submenu for settings of the display	-	-
Luminosity	Setting the luminosity	1 ... 100 %	80 %
Luminosity dimmed	Setting the dimmed luminosity	1 ... 100 %	50 %
Contrast	Setting the contrast	-15 ... 15	0
Colour inversion	Setting the colour inversion	Yes, No	Yes
Screen lock	Activate the screen lock	Yes, No	No
Screen lock after	Setting the delay	1 ... 10 min	2 minutes

11 Internet module

Via the Internet module, the domestic hot water module can be externally activated. For this, a wireless network / WLAN is required to connect the module via the Internet module. Important: For this, the port 2000 must be activated. At the moment, the following possibilities are available:

- Data logging inclusive analysis possibilities via the web service
- Remote maintenance
- Parameter / function modification
- Synchronisation of the time with the Internet

Additional instructions are enclosed to the Internet module. The following data can be additionally set in the domestic hot water controller FC3.10:

11.1 Registration

The registration is required to retrieve data of the domestic hot water module via the Internet and to make settings. With the registration, the module is assigned to a user within the web service.

11.2 Set up the network

Automatic: To set up the IP address automatically, the option *DHCP* is selected. Afterwards, the Internet module retrieves all settings from the DHCP server.

Manually: Via the menu items *IP address*, *Net mask*, *Gateway address* and *DNS address*, it is possible to manually enter the network settings. For information about the values to be entered there, please contact your network administrator.

11.3 Information

In this menu item, the current network settings of the Internet module are displayed. In addition, the firmware version and the MAC address can be seen.

12 Modbus settings*

The domestic hot water module can be connected to the Building Management System (BMS) via the Modbus interface of the FC3.10 controller. In this menu item, the Modbus transfer parameters such as Baudrate, data bits, stop bits, parity etc. can be set.

Detailed information for the setting can be found in chapter "*Connection to Building Management System*".

**Settings only visible with installer code (see chapter "User code").*

13 USB

The controller has a service interface (USB port) for standard USB flash drives. To connect a USB flash drive, first remove the EPP insulation around the controller. In a second step, unscrew the screw in the lower area and remove the white front panel. The USB port is at the right of the display at the side of the controller.



CAUTION

Danger of damage and malfunction!

Subsequent damage by using USB 3.x is possible.

- ▶ Only use USB flash drives of the type 1.x or 2.x for this service interface.

The following functions can be carried out with a USB flash drive:

13.1 Eject memory

Safe removal of a USB flash drive from the system in order to avoid data loss before the data are completely saved.

13.2 Load settings

If there are controller settings on the USB flash drive, you can export them to the controller in the menu item *Load settings*. A message is displayed when the loading is completed. Then the controller is restarted.

13.3 Save settings

This menu item allows to save the controller settings on the USB flash drive. During the saving process, the message *Copying data* is displayed, after that *Copying completed*.

13.4 Save alarm history

This menu item allows to save the alarm history on the USB flash drive. During the saving process, the message *Copying data* is displayed, after that *Copying completed*.

13.5 Save parameter history

This menu item allows to save the parameter history on the USB flash drive. During the saving process, the message *Copying data* is displayed, after that *Copying completed*.

13.6 Data logging interval

Setting of a data logging interval for the data recording. The log interval defines how regularly data should be recorded on the external storage medium.

13.7 Recording type



Selecting of the type of the data recorded.

If in the menu item the recording type *Linear* is set, the recording stops when the capacity limit is reached.

The message *USB stick: no free space* is displayed.

In the setting *Cyclical*, the oldest data on the USB stick are overwritten as soon the capacity limit is reached.

13.8 Format data carrier

Formats the USB flash drive. All data will be deleted on the USB flash drive.

13.9 Properties

Displays the capacity and the free memory on the USB flash drive.

Parameters	Description	Adjustment range	Factory setting
Remove data carrier	Safe removal of the USB flash drive	-	-
Load settings	Load the controller settings	-	-
Save settings	Save the controller settings	-	-
Save alarm history	Save the alarm history	-	-
Save parameter history	Save the parameter history	-	-
Data logging interval	Setting the data logging interval	1 ... 60 s	1 s
Recording type	Setting the recording type	Linear, cyclical	Linear
Format data carrier	Formatting the USB flash drive	-	-
Properties	Properties of the USB flash drive	-	-

14 Automatic/manual mode

In this menu item, you can set the operation mode of all used PWM outputs and relays in the controller as well as a sensor simulation.

With the sensor simulation, a certain temperature can be set for a sensor in order to simulate this temperature. In addition, a certain offset parameter for the automatic mode for all sensors can be set with the menu item *Calibration*.

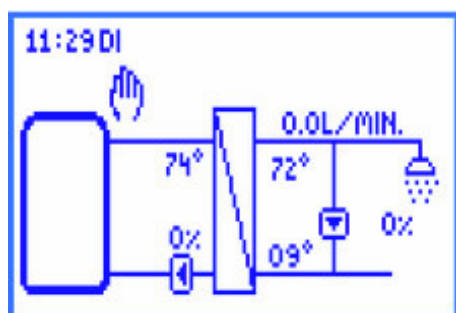

The manual mode has the highest priority.

These setting values overwrite the automatic actuating values of the controller.

If the controller runs in manual mode, a hand symbol is shown on the display of the system overview.

Parameters	Description	Adjustment range	Factory setting
Automatic mode	Sets all outputs to automatic / manual mode	On (automatic), Off (manual mode)	On
Sensor simulation	Goes to the submenu to the simulation of the inputs	-	-
Sensor 1	Sensor 1 (T-FL)	Automatic, simulation (-30 ...150 °C)	Automatic
Sensor 2	Sensor 2	Automatic, simulation (-30 ...150 °C)	Automatic
Sensor 3	Sensor 3	Automatic, simulation (-30 ...150 °C)	Automatic
Sensor 4	Sensor 4 (T-CW)	Automatic, simulation (-30 ...150 °C)	Automatic
VFS/US V	VFS/US flow rate	Automatic, simulation (0.0 ...40.0 l/min)	Automatic

14 Automatic/manual mode

Parameters	Description	Adjustment range	Factory setting
VFS/US T	VFS/US temperature	Automatic, simulation (-30 ...150 °C)	Automatic
Relay 1	Relay 1	Automatic, manual mode (on, off)	Automatic
Relay 2	Relay 2	Automatic, manual mode (on, off)	Automatic
Relay 3	Relay 3	Automatic, manual mode (on, off)	Automatic
PWM1	PWM control of the primary pump	Automatic / manual mode (0.0 ... 100 %)	Automatic
PWM2	PWM control of the circulation pump	Automatic, manual mode (0.0 ... 100 %)	Automatic

15 User code



In this menu, you can enter the user code. According to the entered code, a different access to the setting area of the controller is possible.

Each digit of the four-digit code must be individually entered and confirmed.

After confirming, the cursor goes automatically to the next digit. To receive access to all extended areas of the installation, enter the installation code **9856 or 0011**.

NOTICE

To avoid that settings are incorrectly modified, we recommend to enter the customer user code after completion of all installation work and before the controller is given to uninitiated system operators or customers: **0000**

16 Advanced settings

16.1 Remote control / write protection

A remote control allows a remote monitoring, data logging and setting of parameters of a domestic hot water module even if you are not nearby the module or the controller. All domestic hot water modules based on the FC3.10 controller allow a remote control which can be realised in different ways:

- BMS connection (Modbus RTU protocol)
 - Single controller via the RS-485 interface integrated at the FC3.10
 - Cascade by means of a MB3.10 Modbus RTU module
- WiFi / Internet module (own protocol)

The realisation of the remote control with a WiFi module is described in chapter 11 of these instructions. The connection to BMS is explained in chapter 23.

The function "*Remote control / write protection*" is activated when modifications of single parameters / functions or other settings are meant to be blocked via remote access.

All parameters / functions can be seen or read via the remote control, but they cannot be modified via the remote control. The parameters can exclusively be modified directly on-site at the FC3.10 controller.

The function "Remote control / write protection" can separately be activated or deactivated for the BMS connection of the single controller, MB3.10 or the WiFi module. The additional menu items appear at the display of the FC3.10 controller ("*WiFi module*", "*MB3.10*") if these are connected to the FC3.10 controller and are put into operation (e.g. "*Scan Modbus*" for MB3.10, see chapter 5.7). If required, this (de)activated function can be protected by a personalised password to avoid modifications (on/off) by third parties. Please store this password on a safe place because the activated function / the password cannot be reset, even if you reset to factory settings.

16.2 Minimum speed*

In this menu item, you can adapt the minimum speed of the primary pump.

The minimum speed is an important setting parameter which is exclusively responsible for the control quality in the low load operation (small withdrawal quantity). This minimally actuated PWM value is meant to guarantee the circulation of the heating water (the smallest flow rate) through the domestic hot water module.

An integrated check valve can cause that there is no circulation in the primary circuit at low withdrawal flow rates. This can be solved by slightly increasing the minimum speed.

**Settings only visible with installer code (see chapter "User code").*

17 Description of function

17.1 Circulation

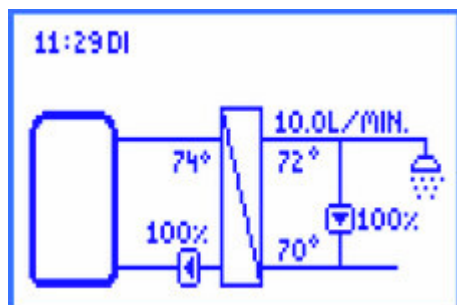

By means of a circulation function, the drinking water in the circulation line is heated to the desired nominal temperature. The designated circulation pump is actuated by the controller via the PWM 2 connection.

During the first commissioning of the circulation pump, you should specify the following parameters to adapt the operation of the domestic hot water module to the current circulation line:

- PWM value (0 ... 100 %) for the control of the circulation pump (PWM 2)
- Temperature sensors for hot and cold water (e.g. T-DHW and T-CW, optional: temperature at the external circulation sensor)

The setting of the PWM value for the pump control is made at the menu item *Circulation -> Pump rotation speed*. All relevant values are displayed in a hydraulic scheme.

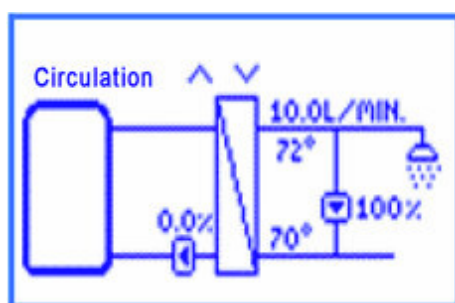

In this menu item, you can set the PWM signal (rotation speed) of the circulation pump with the operating buttons *upwards* and *downwards*. With the setting, the flow in the circulation line is modified, and consequently the temperature difference between inlet and outlet.

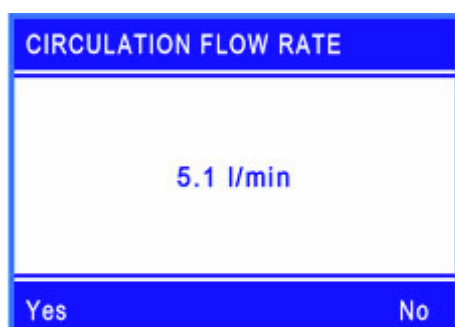

Please confirm the current flow rate which is currently circulated in the circulation mode (no active withdrawal) by the confirmed setting.

This flow rate is taken into account for statistic purposes at *Status -> Measured / balanced values -> Withdrawal quantity* to calculate more exactly the real withdrawal quantities.

NOTICE

An additional external circulation sensor can be defined. This can be useful to minimise the runtimes of the circulation pump or to determine the temperatures of pipes with a bad circulation.

The circulation function offers 3 operating modes which can be combined with each other.

- Temperature control
- Time control
- Demand

Depending on the activated mode, additional settings are required.

Operation mode "temperature control"

As a temperature sensor for the temperature control, either the cold water sensor (T-CW) or an external temperature sensor can be selected. If the temperature measured at the selected sensor falls below the switch-on temperature, the circulation pump is actuated. If the temperature measured at the selected sensor is higher than the switch-off threshold (switch-on temperature + ΔT Off), the circulation pump is switched off.

Operation mode "time control"

There are two possibilities to set the circulation pump in the menu item Time control:

- Continuous operation - the circulation pump runs permanently without interruption
- Time control settings - the circulation pump runs only in a user-defined time window

If the current time lies within a defined time window, the circulation pump is actuated. For each day of the week, up to 5 time windows can be defined.

At *Circulation* -> *Time control* -> *Time control settings*, choose the *Timer (Set)* and define one or multiple time windows on the desired days.

First set the hour, then the minutes of the time when the circulation is meant to start. After confirmation, set the hour and the minutes of the time when the circulation is meant to stop. Please also confirm the end time to completely define the time window.

The time setting of a day can be copied to another day. To copy the settings, select the menu item *Copy*. Then, select the day or the days to which the setting is meant to be copied. Finally, select the menu item *Confirm* in the last line to complete the copying.

At *Circulation* -> *Time control* -> *Time control settings, Preview*, an overview of the defined circulation times is displayed.

Operation mode "demand"

Is a tap open for a few seconds (max 5 s) and closed, the flow rate sensor detects this tap impulse. If the *Demand* mode is activated, this tap impulse initiates the switch-on of the circulation pump for the determined runtime.

After the end of the runtime, the circulation pump is locked for a defined break duration.

During the runtime as well as during the break, no new demand is accepted.

Setting changes made during a circulation in process will not be applied until after the circulation process has ended (break duration included).

Connecting the operation modes

You can connect the 3 circulation operation modes with each other in order to adapt the circulation to your needs. The following combinations are possible:

- **Temperature control + Time control:** The temperature control is only active during the determined time windows. The circulation pump is switched on and off by the conditions of the temperature control.
- **Temperature control + Demand:** The circulation is switched on on demand (tap impulse). The circulation is switched off when the switch-off threshold temperature is exceeded or after the end of the runtime. After that, the demand for a determinable break is locked.
- **Time control + Demand:** During the time windows, the circulation runs continuously. Outside the time windows, the circulation starts on demand and stops after the end of the runtime. After that, the demand for a determinable break is locked.
- **Temperature control + Time control + Demand:** The temperature control is only active during the determined time windows. Outside the time windows on demand. When the desired temperature is reached, the demand ends ahead of time. If it is reached, the function is still locked by the demand for the determined break and can only be activated if the break has ended.

Parameters	Description	Adjustment range	Factory setting
Circulation active	Activate the function	On, Off	Off
Temperature control	Submenu for settings of the temperature control	On, Off	Off
Switch-on temperature	Setting the switch-on temperature	35 ... 75 °C	55 °C
ΔT Off	ΔT for the determination of the switch-off temperature	2 ... 10 K	2 K
Time control	Submenu for settings of the time control	On, Off	Off
Continuous operation	Continuous operation	On, Off	Off
Week settings	Timer function	On, Off	On
Timer	Setting of the time windows	Monday ... Friday 00:00 ... 23:59	-
Demand	Submenu for settings of the demand	On, Off	Off
Runtime	Runtime	00:00 ... 10:00 min	01:00 min
Pause	Pause	0 ... 60 min	10 min
Circulation sensor	Selection of the sensor	T-CW, external sensor (S2 (only for FriwaMini), S3)	T-CW
Pump speed	Setting of the pump speed	0 ... 100 %	40 %

17.2 Stratification (return stratification)

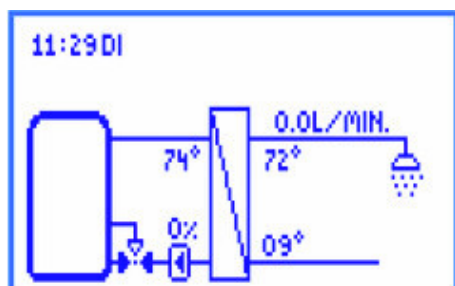

This function serves to improve the temperature stratification in the storage tank or to avoid a temperature mix. In the return can be considerable temperature differences (for example, with an existing circulation). Therefore, the return is connected to the storage tank via a three-way valve.

According to this, the return is fed into the upper or the lower part of the storage tank, depending on the position of the three-way valve.

For this function, 2 modes can be selected:

- Thermostat mode
- Differential mode

At *Stratification -> Sensor selection*, you can select an external sensor as an alternative to the cold water sensor for both modes. The external sensor must be mounted into the return ahead of the three-way valve.

Operation mode "Thermostat mode"

If the switch-on temperature is exceeded at the cold water sensor, the controller activates the relay for the stratification. The return is fed into the upper part of the storage tank. If the temperature at the cold water sensor falls below the switch-off threshold (switch-on temperature - hysteresis), the relay is switched off. The return is fed into the lower part of the storage tank.

Operation mode "Differential mode"

In addition to the temperature at the cold water sensor, the storage temperature is required.

This temperature is measured exclusively via S3. If the temperature difference between the cold water sensor and the storage tank sensor exceeds the value ΔT_{On} , the controller switches on the relay for the stratification. The return is fed into the upper part of the storage tank. If the temperature difference between the cold water sensor and the storage tank sensor exceeds the value ΔT_{Off} , the relay is switched off.

The return is fed into the lower part of the storage tank.

NOTICE

When the *Differential mode* is activated, the controller uses the sensor input S3 to measure the storage tank temperature. The three-way valve has to be installed in such a way that in a currentless state the flow direction is switched towards the colder part of the storage tank.

The storage tank sensor has to be installed in the warmer part of the storage tank.

NOTICE

If the three-way valve was not activated in the last 24 hours, it is opened and closed automatically. This prevents that the valve seizes up after a longer downtime.

Parameters	Description	Adjustment range	Factory setting
Stratification return	Activate the function	On, Off	Off
Selection of relay	Selection of the relay	Relay 1, Relay 2	Relay 2
Thermostat mode	Submenu for settings of the thermostat mode	On, Off	On
Switch-on temp.	Switch-on temperature	20 ... 60 °C	35 °C
Hysteresis	Hysteresis	1 ... 20 K	5 K
Differential mode	Submenu for settings of the differential mode	On, Off	Off
ΔT On	Switch-on temp. difference	1 ... 20 K	10 K
ΔT Off	Switch-off temp. difference	1 ... 20 K	6 K
Sensor selection	Selection of the sensor	T-CW, external sensor (S2 (only for FriwaMini), S3)	T-CW

17.3 Modulating hot water temperature

This function adapts the defined nominal temperature of the hot water if the temperature level in the storage tank is not sufficient.

17 Description of function

The temperature is decreased when the flow temperature (T-FL) is lower than the nominal temperature (D.H.W. set temperature) + 5 K. The decreased nominal temperature is dynamically defined as follows:

Nominal temperature (new) = nominal temperature – 5 K.

After a new withdrawal, the controller starts with the decreased nominal temperature. Only when the flow temperature (T-FL) is 12 K higher than the decreased nominal temperature, it is increased again by 5 K.

Parameters	Description	Adjustment range	Factory setting
Modulating hot water temperature	Activate the function	On, Off	Off

17.4 Comfort function

The comfort function controls the operation of the primary pump when there is no withdrawal and circulation. In order to speed up the start-up process of the module, the flow to the heat exchanger can be warmed up and be maintained on a certain temperature. To do that, the primary pump is actuated depending on the flow temperature. After starting the pump, the comfort function is locked for the duration of a defined break.

An additional limitation to specific time windows is possible by using a weekly timer (detailed information on the time control settings in chapter *Circulation - Time control*).

The nominal temperature for the comfort function cannot be set freely, but is calculated dynamically:

Comfort nominal temperature = hot water nominal temperature - ΔT .

The sensor which measures the comfort nominal temperature is the flow sensor (T-FL / S1). In order to avoid a permanent operation of the primary pump due to a storage tank that is not hot enough, a security query is carried out. If, within 100 seconds after the start of the comfort function, the flow temperature has not reached the calculated comfort nominal temperature, the comfort function is blocked for one hour.

NOTICE

If there is an increased risk of limescale for the heat exchanger, it is recommended to use the comfort function only in a restricted way.

Parameters	Description	Adjustment range	Factory setting
Comfort function	Activate the function	On, Off	Off
Pause	Pause	1 ... 60 min	10 min
ΔT	Temperature difference	1 ... 15 K	5 K
Pump speed	Control primary pump	0 ... 100 %	25 %
Time control			
Continuous operation	Primary pumps runs permanently	On, Off	Off
Week settings	Setting of the time windows	Monday ... Friday 00:00 ... 23:59	-

17.5 Disinfection

WARNING

Danger of scalding due to hot water!

If the function is activated, there is the risk of scalding during the defined time window at all withdrawal points!

- ▶ Inform user
- ▶ Make sure to avoid scalding at the installation

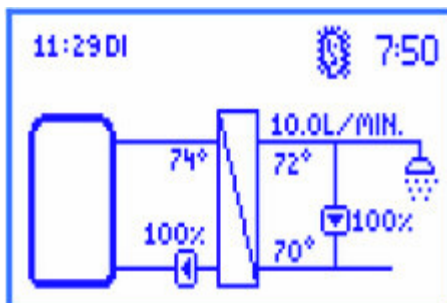

Bigger DHW systems are thermally disinfected in order to kill dangerous germs (such as legionella bacteria) in the system. For this, the domestic hot water module can provide higher hot water temperatures.

If the function is activated, the disinfection automatically starts at the selected disinfection day at the selected disinfection time.

17 Description of function

It is also possible to start the disinfection manually.

When the disinfection starts, the circulation pump is actuated with 100 % speed at the same time and remains switched on for the defined disinfection duration (only when circulation was activated). If the circulation is deactivated, the nominal temperature is overwritten by the disinfection temperature during a withdrawal. During the disinfection, the primary pump is controlled in a way that the defined disinfection temperature is maintained at the hot water outlet.

The disinfection is logged as "successful" when, during the duration of the disinfection, the temperature at the cold water sensor (with circulation) or at the hot water sensor (without circulation) exceeds the temperature (disinfection temperature – 5 K) for the defined time *Disinfection OK after*. A successful disinfection can be automatically stopped before time by selecting *Disinfection -> Stop before time*. At *Disinfection -> Disinfection history* can be seen when a disinfection was carried out and if it was successful or not.

After the end of the disinfection duration, the circulation pump is switched off and the primary pump controls again to the defined hot water nominal temperature.

By deactivating the function, the disinfection is aborted.

Parameters	Description	Adjustment range	Factory setting
Disinfection	Activate the function	On, Off	Off
Manual disinfection	Manual start of the disinfection	On, Off	Off
Disinfection temperature	Setting the disinfection temperature	60 ... 80 °C	60 °C
Duration of disinfection	Setting the duration of disinfection	10 ... 240 min	60 min
Disinfection day	Weekday of the disinfection	Monday ... Friday	-
Disinfection start hour	Start time of the disinfection	0 ... 11:00 p.m.	01:00 a.m.
Disinfection OK after	Duration for which the temperature condition must be met	9 min ... Duration of disinfection – 1 min	15 min

Parameters	Description	Adjustment range	Factory setting
Abort	Activate the automatic abortion	On, Off	Off
Disinfection history	History of previous disinfections	-	-

17.6 Alarm relay

The function *Alarm relay* allows to switch a relay in case of an error. For example, a signal transmitter can be connected which reports errors. If the function is activated, the controller switches the relay in case of an error.

If the option *Inverted* is activated, the relay is always switched on if no error is present. If an error occurs, the controller switches off the relay.

Parameters	Description	Adjustment range	Factory setting
Alarm relay	Activate the function	On, Off	Off
Relay selection	Selection of the relay	Relay 1, Relay 2	-
Inverted	Relay function inverted	On, Off	Off
Pt1000 error	Short-circuit / interruption at a temperature sensor	On, Off	Off
VFS/US error	Short-circuit / interruption / exceeding or falling under the measuring range at the flow rate sensor	On, Off	Off
µC error	µC error	On, Off	Off
Time error	Time not defined or lost	On, Off	Off
Communication error	Communication error in the cascade network	On, Off	Off
Disinfection error	Disinfection not successfully completed	On, Off	Off

17 Description of function

17.7 Parallel relay

The function *Parallel relay* makes it possible to switch an additional relay in case of an error. It is possible to select what kind of incident causes the relay to be switched.

Example: The parallel relay R2 is chosen for the primary pump. Whenever the controller sends a signal to the primary pump, the relay R2 is switched.

This can be useful to switch hydraulic paths on or off using a zone valve, for example.

Parameters	Description	Adjustment range	Factory setting
Parallel relay	Activate the function	On, Off	Off
Relay 1	Submenu to relay 1	-	-
Deactivated	Status of the relay	On, Off	On
Primary pump	Connects in parallel to the primary pump	On, Off	Off
Circulation pump	Connects in parallel to the circulation pump	On, Off	Off
Disinfection	Connects in parallel to the disinfection	On, Off	Off
Disinfection error	Connects in parallel if disinfection was not successful	On, Off	Off
Relay 2	Submenu to relay 2	-	-
Deactivated	Status of the relay	On, Off	On
Primary pump	Connects in parallel to the primary pump	On, Off	Off
Circulation pump	Connects in parallel to the circulation pump	On, Off	Off
Disinfection	Connects in parallel to the disinfection	On, Off	Off
Disinfection error	Connects in parallel if disinfection was not successful	On, Off	Off

17.8 Hygienic flush / protection against blocking

The function *Hygienic flush / protection against blocking* serves to avoid that the circulation pump seizes up after a longer downtime. During cascade operation, it also serves to flush the cascade modules in operation which are switched on alternately.

The module is flushed every 24 hours at a defined time for a defined duration.

Parameters	Description	Adjustment range	Factory setting
Hygienic flush / protection against blocking	Activate the function	On, Off	Off
Start time	Start time of the hygienic flush	0 ... 11:00 p.m.	10:00 a.m.
Flush duration	Duration of hygienic flush	00:00 ... 10:00 min	05:00 min

17.9 Buffer tank*

The function *Buffer tank* prevents an unintended heat transfer from the secondary side of the domestic hot water module to the primary side. In this case, the circulation pump is switched off in the circulation mode. This does not influence the operation during the Disinfection.

If the storage tank temperature is equal or less than the cold water temperature, the activation of the circulation pump is blocked. The blocking is revoked as soon as the storage tank temperature is 5 K higher than the cold water temperature.

If the function is activated, the additional temperature is displayed in the buffer tank.

**Settings only visible with installer code (see chapter "User code").*

Parameters	Description	Adjustment range	Factory setting
Buffer tank	Activation of the function	On, Off	Off
Buffer sensor	Selection of the sensor	Sensor 2 (only for FriwaMini), Sensor 3	-

17 Description of function

17.10 Reheating*

If the temperature in the buffer tank is not sufficiently high, a reheat request can be sent to the boiler via a defined relay.

If the buffer tank temperature is equal or less than the hot water nominal temperature + 3 K, the relay is switched on. The reheat request is sent to a boiler.

If the buffer tank temperature is equal or higher than the hot water nominal temperature + 8 K, the relay is switched off. No reheating is required.

**Settings only visible with installer code (see chapter "User code").*

Parameters	Description	Adjustment range	Factory setting
Post-heating	Activate the function	On, Off	Off
Sensor selection	Selection of the sensor	Sensor 2 (only for FriwaMini), Sensor 3	-
Relay selection	Selection of the relay	Relay 1, Relay 2	-

18 Installation of the cascade controller

Domestic hot water modules (max. 4) that are connected hydraulically in parallel with each other are called cascade. The following installation/mounting steps are required to prepare the modules for the cascade operation.

First connect the domestic hot water modules hydraulically, flush them and fill them hydraulically. Then, define which domestic hot water module is called client.

The term client comes from the Modbus RTU protocol and describes the serial client-server communication. Via the client, the basic settings are made and also functions are set. Also, the circulation pump is electrically connected and it is determined which is used for the cascade. The other controllers are called server 1, server 2 or server 3, depending how many controllers are available.

Please note: The three-way valve for the stratification is exclusively connected electronically to the controller of the server 1.

The controllers must be arranged from left to right in the following order:

client, server 1, server 2, server 3.

If additionally, a MB3.10 Modbus RTU module is connected, it should exclusively be connected with the client via the bus line / communication cable. For further details, please refer to the separate operation instructions of the MB3.10 (PAW item no. 1339002).

In the following illustration you can see an example of a 4-fold cascade. To connect the two-way zone valves (cascade valves), the three-way valve for the improved stratification control in the storage tank (return stratification) as well as the controller via a bus line, follow the steps in chapter 18.1.

18 Installation of the cascade controller

18.1 Installation

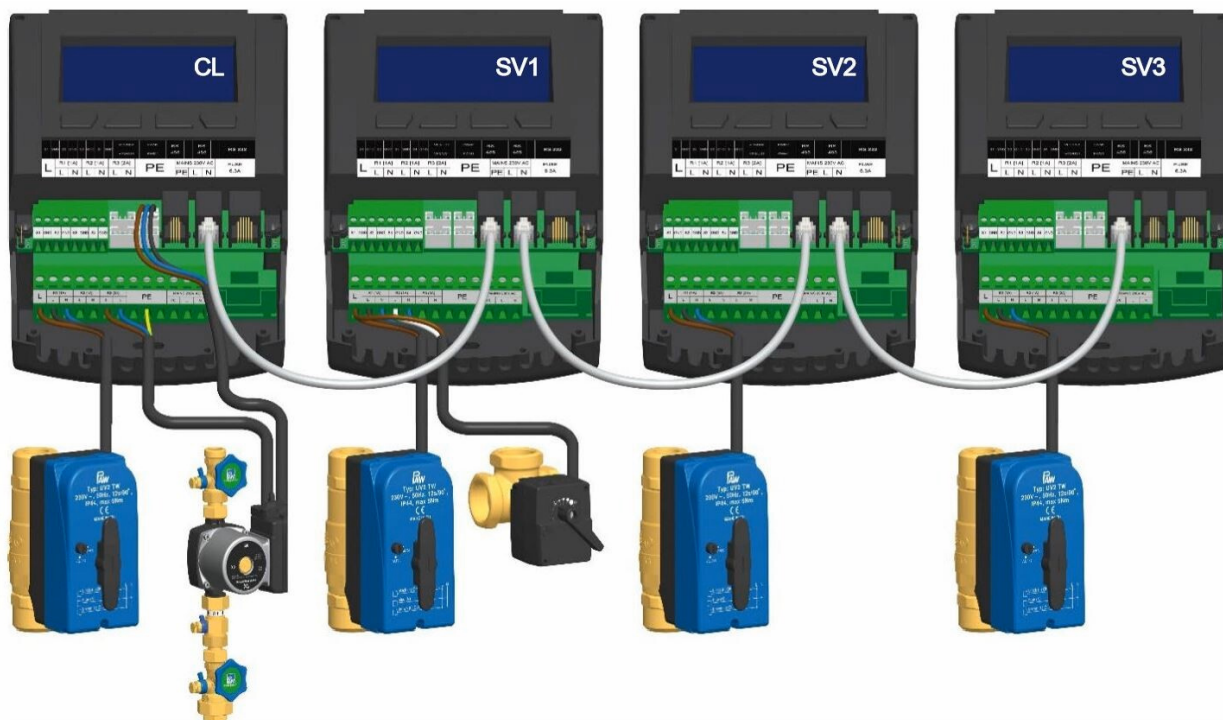

During the installation, please observe the instructions in chapter 3.1 and 3.2.

WARNING



Risk to life and limb due to electric shock!

- ▶ Disconnect the controller from the power supply before opening the body.
- ▶ Make sure that the power supply cannot be unintentionally switched on when the body is open.

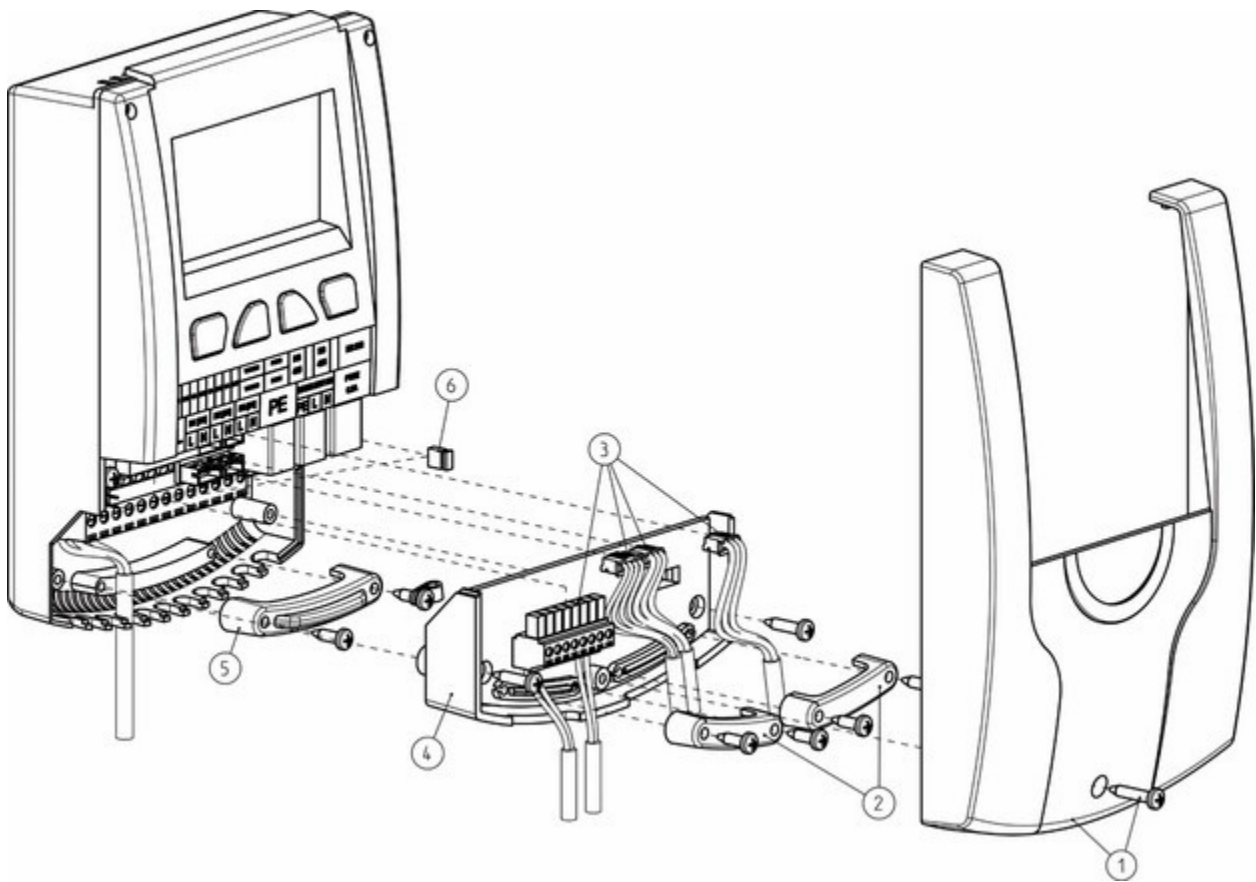

1. Remove the white front panel of the controller (1).
2. Then, remove the strain reliefs (2).
3. After that, remove the sensor cables of the VFS/US sensors, of the PWM signal and the temperature sensors from the controller circuit board plug connector (3).
4. In the next step, unscrew the two screws to remove the intermediate level (4).
5. Remove the strain relief on the 230 V level (5). Now, connect the cascade valve to the output relay 1. If also a three-way valve for the improved stratification control in the storage tank (return stratification) must be connected, use the output relay 2 of the server 1. Use a duo wire end ferrule (twin wire end ferrule) for the crimping if two wires are meant to be mounted below one screw terminal. Please note that the polarity is established as shown in the following illustration.

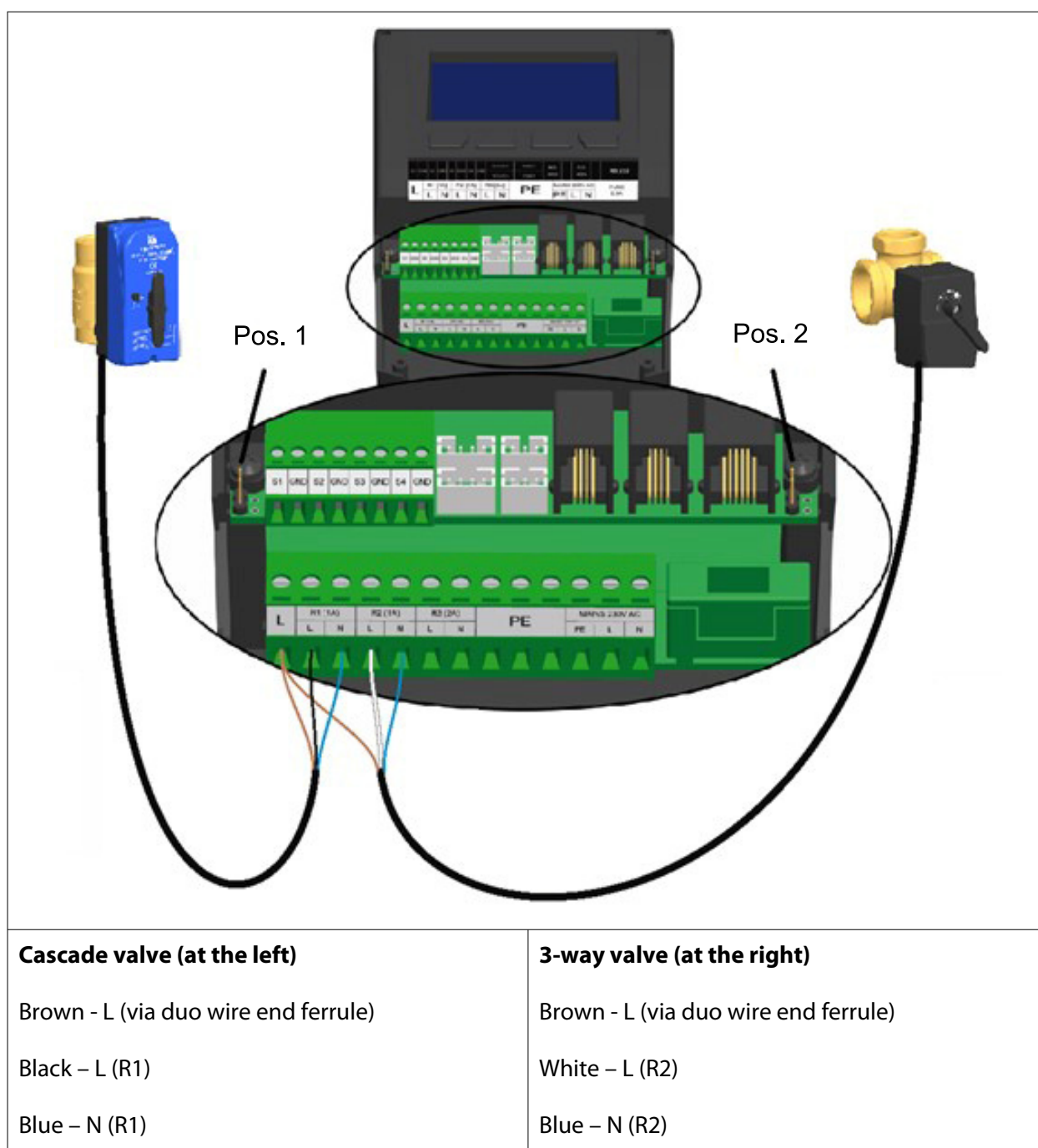

The circulation pump must be electrically connected to the client.

Both pumps (primary pump and circulation pump) must be connected to the relay 3 by means of the duo wire end ferrules.

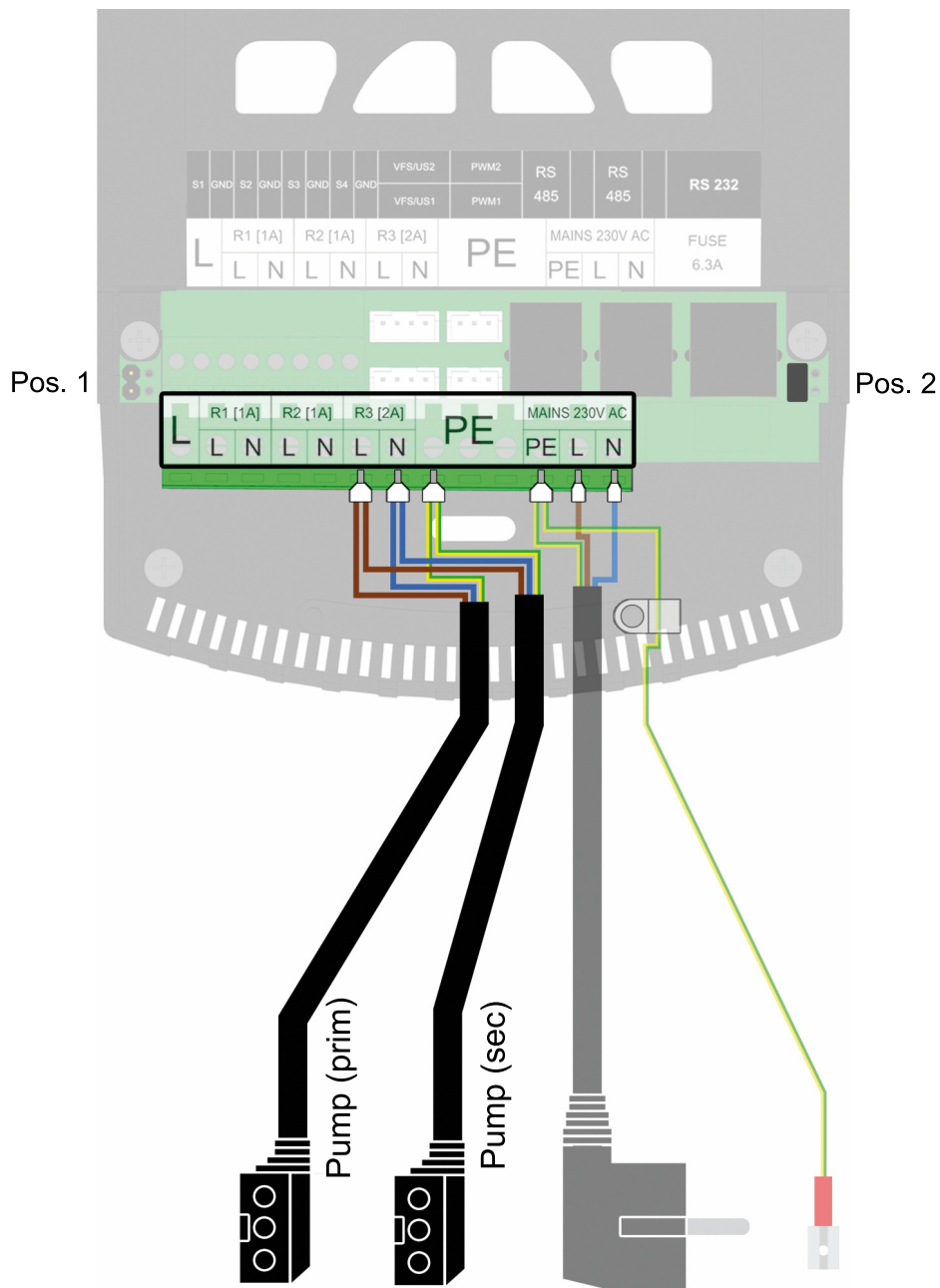

6. For the first and last participant of the Modbus communication, the jumpers must be placed in position 2 (see upper illustration). Place the jumpers as follows:

Number of cascade modules	Client	Server 1	Server 2	Server 3
2	Pos. 2	Pos. 2	-	-
3	Pos. 2	Pos. 1	Pos. 2	-
4	Pos. 2	Pos. 1	Pos. 1	Pos. 2

18 Installation of the cascade controller

If the MB3.10 is meant to be connected as well, plug the jumpers as follows:

Number of cascade modules	MB3.10	Client	Server 1	Server 2	Server 3
2	Pos. 2	Pos. 1	Pos. 2	-	-
3	Pos. 2	Pos. 1	Pos. 1	Pos. 2	-
4	Pos. 2	Pos. 1	Pos. 1	Pos. 1	Pos. 2

7. Then, mount the strain relief (5) and the intermediate level (4).
8. Connect the cascade controllers via RJ10 bus line with each other, as shown in the illustration in chapter 18.
9. Connect the sensor cables (3) with the controller.
10. Mount the strain relief (2).
11. Mount the front panel (1) and fix it by using screws.

18.2 Initial commissioning of the cascade controller

If the entire cascade is hydraulically filled and electrically connected, the mains connection must be established.

In the case of an initial commissioning and the first mains connection of the cascade controllers, start the installation in the menu item *Commissioning*.

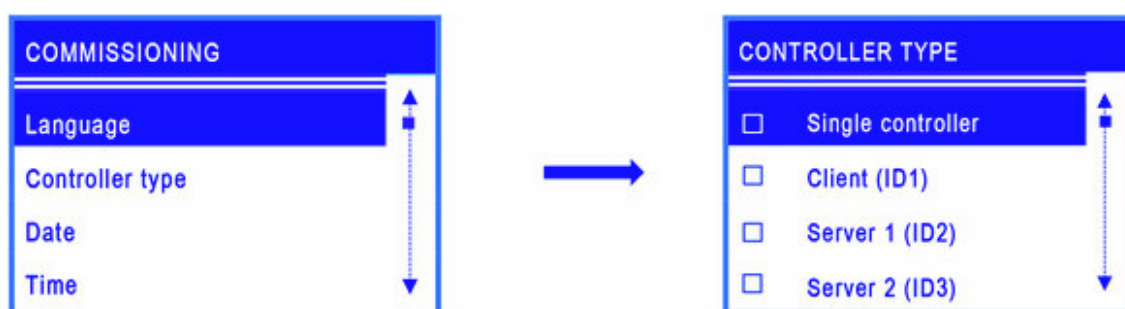

After the selection of the desired menu language, choose the corresponding controller type: client, server 1, server 2 or server 3. Please note that a controller type cannot be selected twice within a cascade.



If the controller was marked as client, the following message is shown.

Now, assign the correct controller types to the other modules. If a controller was marked as a server, the menu items of the commissioning are shortened because the main parameters are set via the client.

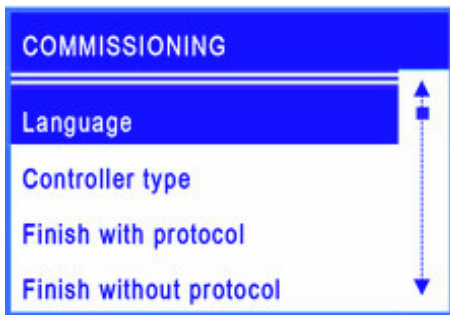

To complete the commissioning at the servers, confirm the items *Finish with protocol* (for this, a USB flash drive must be connected to the controller) or *Finish without protocol*.

Now, at the client, go to the menu item *Scan Modbus*. In the following, a search run starts which identifies the connected controllers in the cascade system. If a server was detected by the client, it is marked with *OK*. After that, leave the menu via the *Back* button.

Now, the automatic synchronisation of all controllers in the cascade starts. When it is completed, the message *"Synchronisation finished"* is displayed.

Attention: If the number of the communicating domestic hot water modules is modified within the cascade (e.g. server X is being maintained) or the MB3.10 is switched on or off, *Scan Modbus* must be repeated to specify the exact number of the participants within the Modbus network.

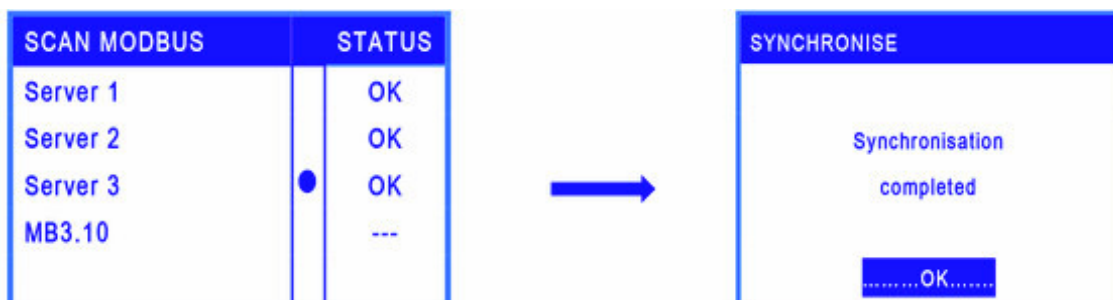

NOTICE

If a server has an error message, such as a sensor failure, the note "error" is displayed next to the respective module. However, the communication is still available.

If a module is not detected or is incorrectly connected, or if an incorrect controller type is set at the server, the note "---" is still displayed.

If the client was able to detect the servers in the network and if no errors occur, the note "OK" is displayed.

If there are different module types within the cascade, the following note is displayed after cancelling the Modbus scan "Attention! Different module types".

Please also note that the firmware version of all cascade controllers must be identical.

If all connected modules are marked with OK, a secure connection between all controllers was established. Now carry out the further commissioning, see corresponding chapter.

From now on, the settings in the commissioning menu can only be made via the client (language, controller type still at the server). After any modifications, the settings at the client are synchronised with the servers.

18.3 Extension of a single controller to a cascade network

If you already have a FC3.10 domestic hot water system as a single controller and if you wish to extend it to a cascade network, you first need to enter the installation code, see chapter 15.

After that, the cascade network can be extended via *Basic settings* -> *Commissioning* and can be put into operation. Please observe the instructions in chapter 10.6 and in chapter 18.2.

19 Menu settings cascade

By pressing the Confirm-button, the menu of the FC3.10 controller opens.

The menu bar contains multiple submenus in which you can find or modify various settings. The available menu items of the first three levels are shown as a menu tree on the basis of the client and will be explained in detail in the following chapters. Please note that the client contains more menu items because the main settings are made via the client. The available menu items of a server are marked with ** in this menu tree.

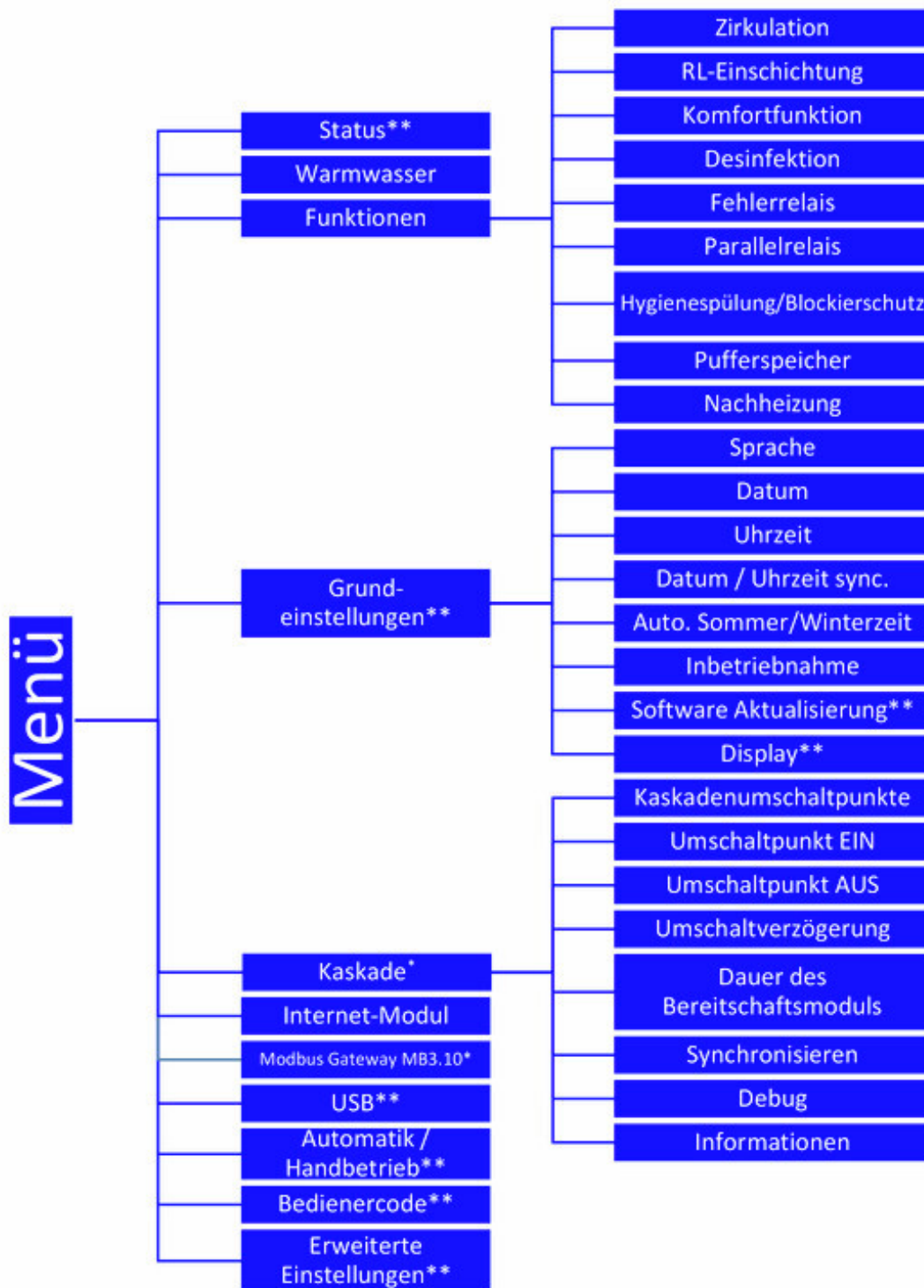

*Settings only visible with installer code (see chapter "User code").

**Settings are visible at the servers.

20 Submenu Cascade at the client

The main setting options were already described in the chapters 7-17. The menu item "Modbus Gateway MB3.10" is described in detail in chapter 23 "Connection to Building Management System" (see 23.2 "Cascade"). The submenu *Cascade* is only visible at the client and contains the following setting parameters:

20.1 Cascade switchover points

If a withdrawal flow rate falls under or over the determined threshold, an additional domestic hot water module is switched off or on via the cascade valve.

CASCADE SWITCHOVER POINTS	
ACTIVE MODULES: 2	
MAX. FLOW	56.0 L/MIN
SWITCH ON (80%)	44.8 L/MIN
SWITCH OFF (30%)	16.8 L/MIN

This menu is an overview for the minimum withdrawal flow rate when the respective domestic hot water module / cascade module is switched on or off. You can navigate through the 4 modules with the *upwards* and *downwards* buttons.

Max. flow: Indicates the maximum withdrawal flow rate for the number of modules, see example: 56.0 l/min for 2 active modules.

Switch on (80 %): This marks the threshold for the minimum flow rate when the next module is switched on. In the example, the third module would switch on at a minimum flow rate of 44.8 l/min and the cascade valve would open.

Switch off (30 %): This marks the threshold for the minimum flow rate when the corresponding module is switched off. In the example, the second module switches off if the flow rate falls below 16.8 l/min.

20.2 Switchover point ON*

Here you can define the threshold for the minimum flow rate when the next module is switched on and the cascade valve opens. The percentage refers to the maximum flow rate of the active modules. Please note the automatic connection of the switchover points ON and OFF, a modification can impact the control performance.

20 Submenu Cascade at the client

20.3 Switchover point OFF*

Here you can define the threshold for the minimum flow rate when the active module is switched off and the cascade valve closes. The percentage refers to the maximum flow rate of the active modules.

Please note the automatic connection of the switchover points ON and OFF, a modification can impact the control performance.

20.4 Switchover delay*

Allows to set a delay after which time a new module is meant to switch on/switch off.

For example, if the threshold for the switching on of a module is exceeded, the next module is only switched on after the defined switching delay.

20.5 Duration of standby module*

A standby module is a domestic hot water module whose cascade valve is still open at that moment, even if there is no withdrawal. There is always only one standby module, the other modules with open cascade valves (if available) are called switch on modules. The domestic hot water modules alternately assume the role as standby module in order to distribute the operating hours equally to the modules. Via the menu item, you can define the duration how long a standby module should be activated before it is exchanged to the next standby module which has the lowest operation time of the pump.

20.6 Synchronise*

In case of modifications in the menu of the cascade, a separate synchronisation can be required if the settings are transmitted incorrectly.

In this case, all settings of the client are transmitted again to the connected MB3.10 servers.

Parameters	Description	Adjustment range	Factory setting
Cascade switchover points	Overview for the minimum flow rate when a module is activated or switched off	-	-
Switchover point ON	Threshold for the minimum flow rate when the next module is activated	70 ... 100 %	80 %
Switchover point OFF	Threshold for the minimum flow rate when the module switches off	0 ... 70 %	30 %
Switchover delay	Allows the activation of a delay for activating/switching off	00:00 ... 10:00 min	00:00 min
Duration of standby module	Duration how long a standby module is active	00:01 ... 07:00 hours	07:00 hours
Synchronise	Transferring the settings from the client to the MB3.10 server	Yes, No	-

21 Submenus at the server

At the server, there is only a small number of setting options available after the commissioning.

21.1 Status

Measured and balance values are measured and displayed per controller. In addition, you receive information about the error messages, the selected service settings and the installed firmware version. For further information, see chapter 7.

21.2 General settings

In the general settings, you can make modifications at the servers via the display.

These include luminosity, dimmed luminosity and contrast.

It is also possible to make a software update.

21.3 USB

If a USB flash drive is connected to the controllers, you must make the corresponding settings separately at the different modules. Before removing a USB flash drive, always confirm *Eject memory*

21.4 Automatic / manual mode

Setting options for the automatic/manual mode are made for each controller, see chapter 14.

22 Functions in the cascade network

To use the functions Circulation and Stratification, the modules must be connected as shown in the following illustration: three domestic hot water modules: client (at the left), server 1 (centre) and server 2 (at the right).

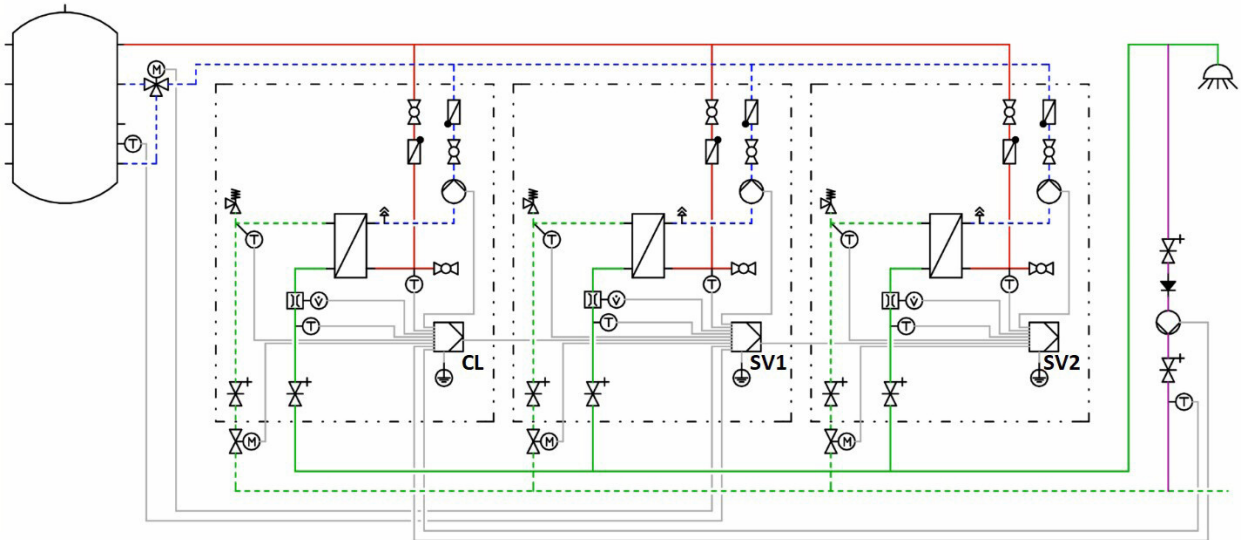

22.1 Circulation

NOTICE

The settings for the circulation menu can only be made and monitored via the client in the cascade network. In addition, the circulation pump must be electrically connected via the client. For further information, see chapter 18.1.

There is always only one circulation pump within the entire cascade. If this function is activated, it only appears on the client display. The client display is shown as in the display view in chapter 17.1.

Identically to the single controller, the circulation function provides 3 different operating modes, which can be combined with each other.

- Temperature control
- Time control
- Demand

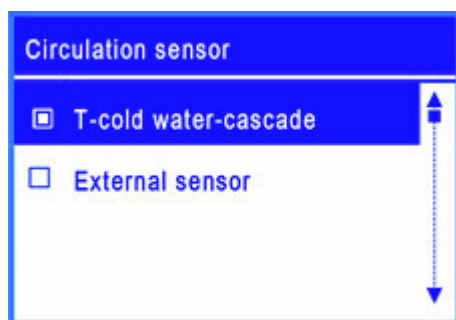

The special characteristic of the temperature control at the cascade is the selection of a new sensor which is called *T-cold water-cascade*.

T-cold water-cascade is the highest temperature of the T-CW sensors of all active modules/domestic hot water modules. Alternatively, an *external sensor* can be selected.

If an external sensor is selected, the sensor must be connected to the client. For a FriwaMini Cascade, you can select *Sensor 2* and *Sensor 3*. For a FriwaMidi, FriwaMaxi or FriwaMega cascade the *external sensor* must be connected to input *Sensor 3* and activated in the menu item *Circulation sensor*.

22.2 Stratification return

NOTICE

The settings for the stratification can only be made and monitored via the client in the cascade network.

The three-way valve and the external sensor, which is meant to be used for the function, must be electrically connected to the controller of server 1.

For the selection of the stratification, the relay 2 of server 1 is already preset and cannot be modified.

To avoid a temperature mix in the storage tank, the supply of the primary return can be realised in two different levels by means of a three-way valve. Similar to the individual controller, this function can be selected in two modes for cascade:

- Thermostat mode
- Differential mode

In the thermostat mode, the temperature can be monitored either via *T-cold water-cascade* sensor or via an *external sensor*. The *T-cold water-cascade* sensor is the highest temperature of the T-CW sensors of all active modules/domestic hot water modules. For the parameter *External sensor*, you can select between *server 1 - sensor 2* (only for FriwaMini) or *server 1 - sensor 3* (FriwaMidi / FriwaMaxi / FriwaMega).

In the differential mode, *server 1 - sensor 3* is used for measuring the storage tank temperature and is already preset. In order to monitor the temperature in the return line, the sensor *T-cold water-cascade* is used for a FriwaMidi / FriwaMaxi / FriwaMega module. For a FriwaMini module, an *external sensor* can be used for a precise monitoring of the temperature in the return line. The external sensor can be connected to the input *server 1 - sensor 2*. The measured values of the external sensors can be read at the SV1- FC3.10 controller at *Menu -> Status >- Measured values -> Sensors*.

22.3 Comfort function

When the comfort function is activated, the heat exchanger of the standby module is maintained in the defined temperature range in the flow line. This allows to ensure a faster hot water preparation in the cascade network. The setting options in the cascade network are identical to those for a single controller, see chapter 17.4.

22.4 Thermal disinfection

WARNING

Danger of scalding due to hot water!

If the function is activated, there is the risk of scalding during the defined time window at all withdrawal points!

- ▶ Inform user
- ▶ Make sure to avoid scalding at the installation

This function is also set and monitored via the client. The client transfers the settings to the controllers and servers.

When a disinfection starts, all cascade valves are opened. This means, all modules carry out the disinfection at the same time.

The disinfection is logged as "successful" when, during the duration of the disinfection, the temperature at the cold water inlet (with circulation) or hot water outlet (without circulation) has exceeded the temperature (disinfection temperature - 5 K) for the defined time *Disinfection OK* after. If a module from the cascade network meets these conditions at an earlier time, its cascade valve is closed. If a module could not reach the temperature (disinfection temperature - 5 K) for the defined duration, it is displayed with "disinfection error" on the controller.

22.5 Alarm relay

This function can be set via the client and can be connected via a free output to different modules. This allows to connect the alarm relay which is meant to be activated to the relay 2 of the server 1 (if no three-way valve is active), of the server 2 or the server 3.

22.6 Parallel relay

This function is set and monitored via the client. It is possible to connect multiple parallel relays. These can be connected to the free relays 2 of the clients/servers. This allows to link each parallel relay with a function via the menu and therefore to be activated.

22.7 Hygienic flush / protection against blocking

In the cascade operation mode, the hygienic flush always starts after a standby module was changed. You can also determine a particular time in the function when the primary pump is meant to run for the defined runtime.

22.8 Buffer tank

This function reacts in the cascade network identically to an operation via a single controller. No specific characteristics must be observed in the cascade operation mode.

22.9 Post-heating

This function reacts in the cascade network identically to an operation via a single controller. No specific characteristics must be observed in the cascade operation mode.

23 Connection to Building Management System

The connection to the Building Management System (BMS) can be realised for an individual domestic hot water module as well as for cascade operation (up to 4 single modules). The BMS connection is carried out via the Modbus interface of the controller (single domestic hot water module) or the Modbus RTU module MB3.10 (in the following abbreviated MB3.10) for Friwa Cascade. For the data exchange between the participants of the bus, the Modbus RTU protocol is used.

23.1 Single domestic hot water module

Connection of the controller to BMS

The domestic hot water modules with the FC3.10 controller have the great advantage that the Modbus interface already exists at the controller. No additional hardware is required to realise the BMS connection. Please use the PAW original communication cable RJ10 (item no. N00317) to connect the FC3.10 controller to the BMS.

Insert one plug of the cable into the RS-485 port of the FC3.10 controller.

Use the other plug for the BMS connection.

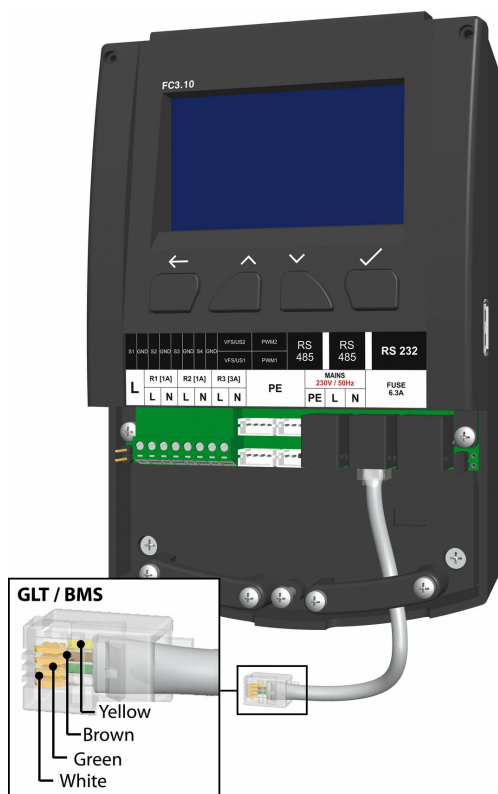

If the connection to the BMS is meant to be realised via a clamping connection, please consider the pin assignment of the communication cable.

Yellow: Communication A+

Brown: GND

Green: Communication B-

White: GND

If the FC3.10 controller is operated as the physical first / last device in the Modbus network, a termination via a jumper is required. For this, the jumper must be plugged at the right side of the controller (see chapter "*Installation of the cascade controller*") to activate the termination resistance (120 Ohm). If the termination is not required, the jumper is plugged onto the placeholder (at the left side of the controller).

Setting at the FC3.10 controller

The Modbus transfer parameters must have identical settings for all devices connected to the BMS. Please set these Modbus transfer parameters in the menu *Modbus settings* by using the installation code **9856 / 0011**.

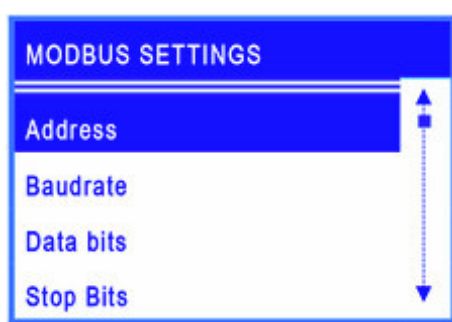

The address is a personal allocation number of the FC3.10 controller (server) within the bus, which the BMS addresses to during the communication.

The speed of the data transfer is set by the parameter Baudrate.

Further setting parameters such as Data bits, Stop bits and Parity describe the basic Modbus communication technology and must be identical to the parameters of the BMS which is meant to be connected.

The *Timeout* parameter is the period of time in which at least one communication between the BMS and the FC3.10 controller must take place.

If no communication takes place within this period of time, the FC3.10 controller interprets this as "Timeout error".

23.2 Cascade

A Friwa Cascade (up to 4 modules) can, as well as an single module, only be connected to the BMS as a bus participant. For this, the MB3.10 (PAW item no. 1339002) is required.

Connection of the cascade to BMS

The following graphic illustrates the connection of a Friwa Cascade (4 modules) to the BMS via MB3.10. Please note that the MB3.10 (far left) is exclusively connected with the client. For further information, please refer to the operation instructions of the Modbus RTU module MB3.10.

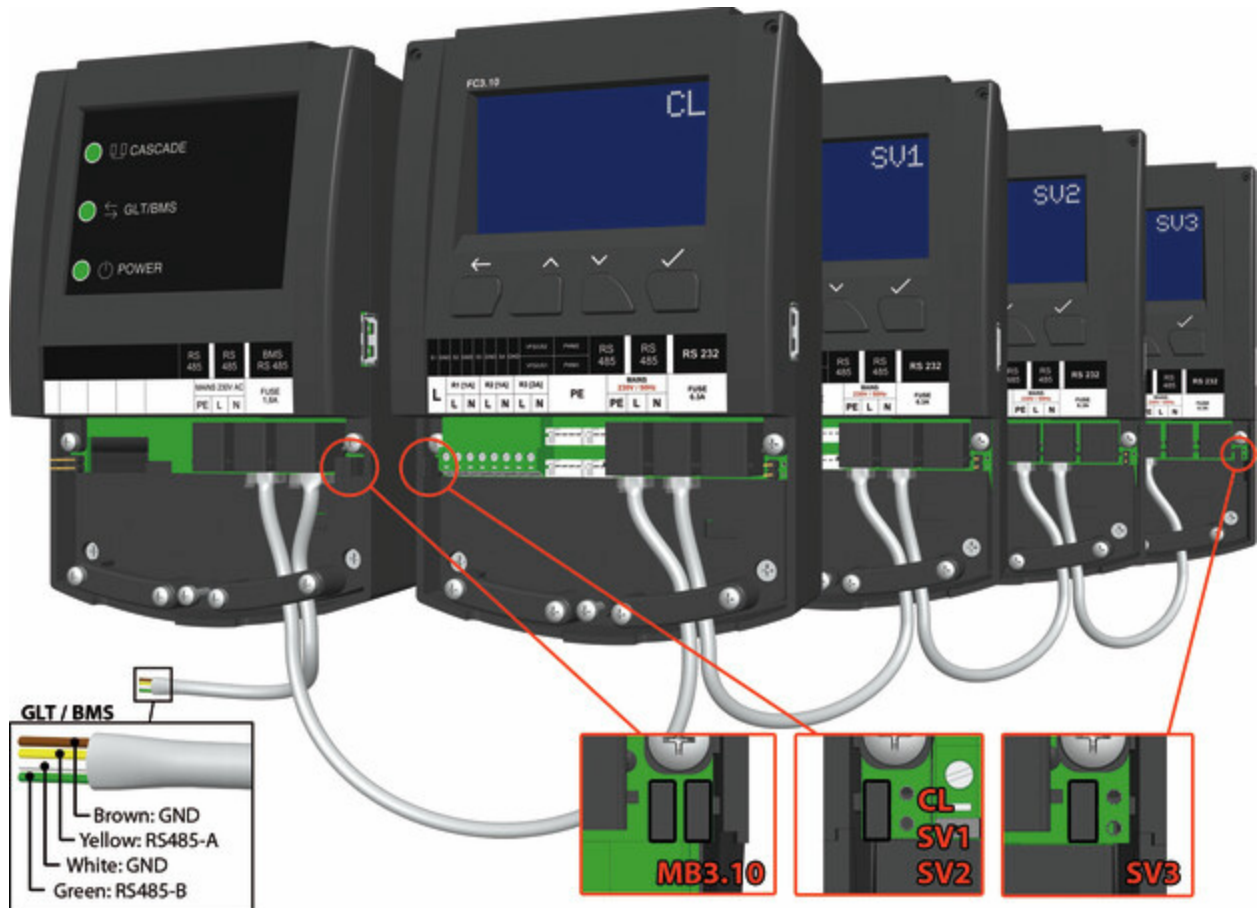

Setting of the MB3.10

After the electrical connection, all required settings must be made at the FC3.10 "Client" and not at the MB3.10. For this, navigate to the menu item *Scan Modbus: Menu -> General settings -> Commissioning* by using the installation user code **9856** (possibly installation code *0011* for customer specific controller versions). A search run starts which assigns the connected controllers in the cascade system and the connected MB3.10. As soon as the MB3.10 (as well as the FC3.10 controller) are identified, *OK* is displayed in the respective line. After all components have reached the status *OK*, leave the menu via the button *Back*.

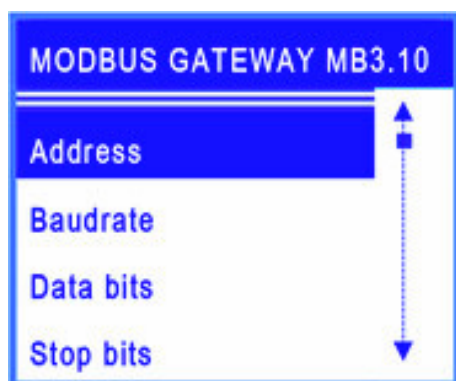

In the main menu at the client, now an additional menu item appears - Modbus Gateway MB3.10.

As in the previous chapter, the Modbus transfer parameters must have identical settings for all devices connected to the BMS.

The speed of the data transfer is set by the parameter *Baudrate*.

Further setting parameters such as *Data bits*, *Stop bits* and *Parity* describe the basic Modbus communication technology and must be identical to the parameters of the BMS which is meant to be connected. The *Timeout* parameter is the period of time in which at least one communication between the BMS and the MB3.10 must take place. If no communication takes place within this period of time, the FC3.10 controller interprets this as "*Timeout error*".

Via the entry *Factory settings*, you can reset the MB3.10 to the default settings. The last menu item *Information* shows the current firmware and bootloader version of the MB3.10.

Parameters	Adjustment range	Factory setting
Address	1 ... 247	64
Baudrate	2400 ... 57600 bps	38400
Data bits	8 ... 9	8
Stop bits	1 ... 2	1
Parity	None/Even/Odd	Odd
Timeout	00:30 ... 30:00	03:00

23.3 List of the Modbus registers

Via the BMS connection, you can remotely read or modify various parameters of a domestic hot water module or cascade. You will find a complete list of all Modbus registers (ca. 2000) of domestic hot water modules in a separate document which can be downloaded via the website www.paw.eu or is available on demand directly at PAW.

24 Technical data

General	
Rated voltage (system voltage)	230 V/AC, 50 Hz
Own consumption	< 2.5 W
Own consumption standby	< 1 W
Fuse element	6.3 A

Outputs		
Outputs R1, R2	Type	Relay
	Switching current	1 A
	Voltage	230 V/AC, 50 Hz
Output R3	Type	Relay
	Switching current	3 A
	Voltage	230 V/AC, 50 Hz
Total	Switching current	5 A
	Voltage	230 V/AC, 50 Hz

Signal inputs		
Temperature	Number	4
	Designation	S1 ... S4, sensor 1 ... 4
Flow rate	Number	2
	Type	VFS / US
	Channels per sensor	2 (flow rate and temperature)
	Voltage	5 V/DC \pm 5%
	Current (max.)	20 mA
PWM	Number	2
	Frequency	75 Hz
	Voltage	10 V

Signal outputs		
PWM	Number	2
	Frequency	200 Hz
	Voltage	10 V
	Current (max.)	10 mA
Modbus	Number of connections	2 RJ10
	Type	
Internal bus	Number of connections	1 RJ12
	Type	

Application conditions	
Protection category	IP20
Protection class	I
Ambient temperature	0 ... 50 °C, in the case of free wall assembly

Physical values	
Dimensions L x W x H	164 x 112 x 55 mm
Weight	390 g
Controller body temperature	max. 90 °C

25 Error correction

25.1 Error messages

WARNING	
	<p>Risk of death by electrocution!</p> <ul style="list-style-type: none"> ▶ Immediately disconnect the device from the power supply if it can no longer be operated safely, f. ex. in the case of visible damage. ▶ Disconnect the device from the power supply before opening the body. ▶ All work on the open device may only be carried out by professional personnel.

NOTICE
<p>The controller is a quality product which has been conceived for numerous years of continuous operation. Please observe the following aspects:</p> <p>The cause of an error is often not the controller but one of the connected components.</p> <p>The following notes about fault localisation indicate the most frequent causes of error.</p>

Alarm	Possible cause	Problem solution
Damaged sensor 1	- short circuit or failure of the sensor - damaged sensor	Check sensor for proper connection, in case of defective sensor: exchange sensor if necessary
Damaged sensor 2		
Damaged sensor 3		
Damaged sensor 4		
VFS/US V error		
VFS/US T error		
Ethernet error	- module is separated - module is faulty	Check module for proper connection
Modbus communication error	- separated Modbus cable - failure of a controller in a cascade network	Check the Modbus communication for proper connection
Disinfection error	- disinfection temperature was not reached within the defined time window	Check buffer temperature
USB stick: no free space	- USB memory is full	Insert a new storage medium, modify recording type

25.2 Troubleshooting

Pump noises can be heard, bubble noises in the pipe.

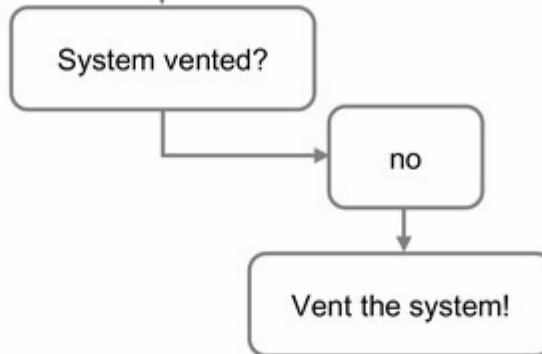

Withdrawal quantity is too low.

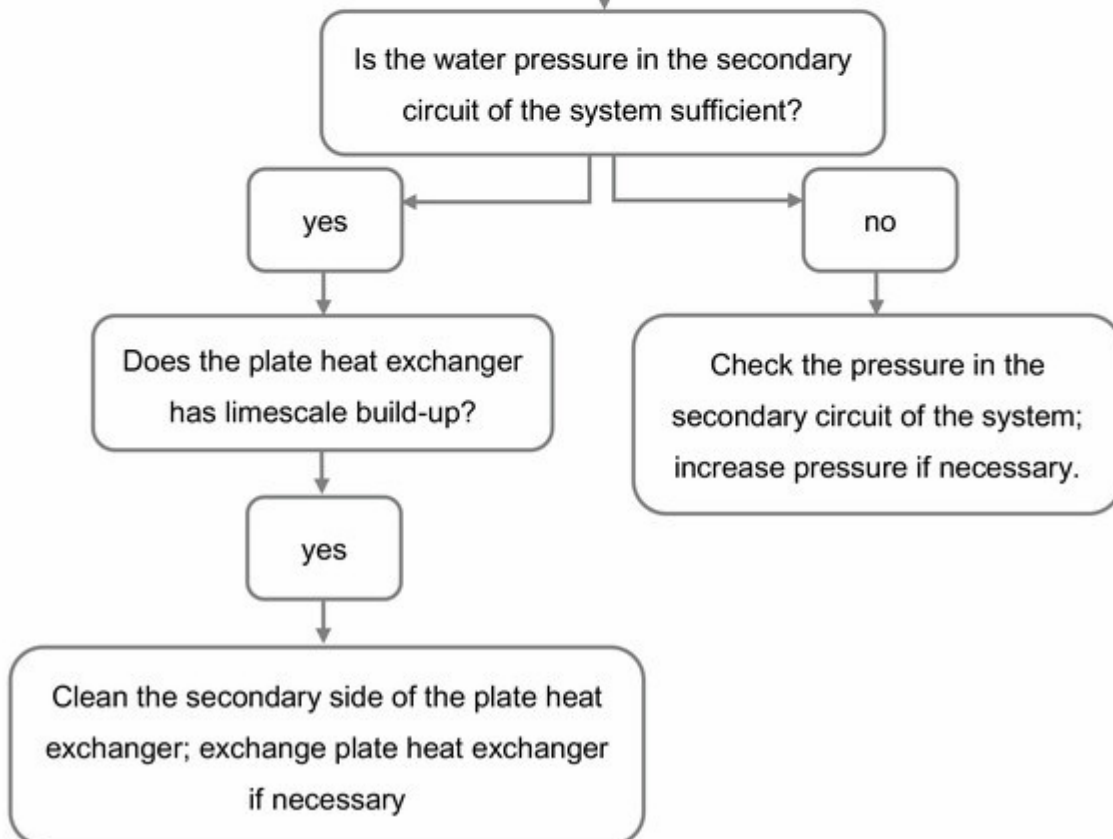

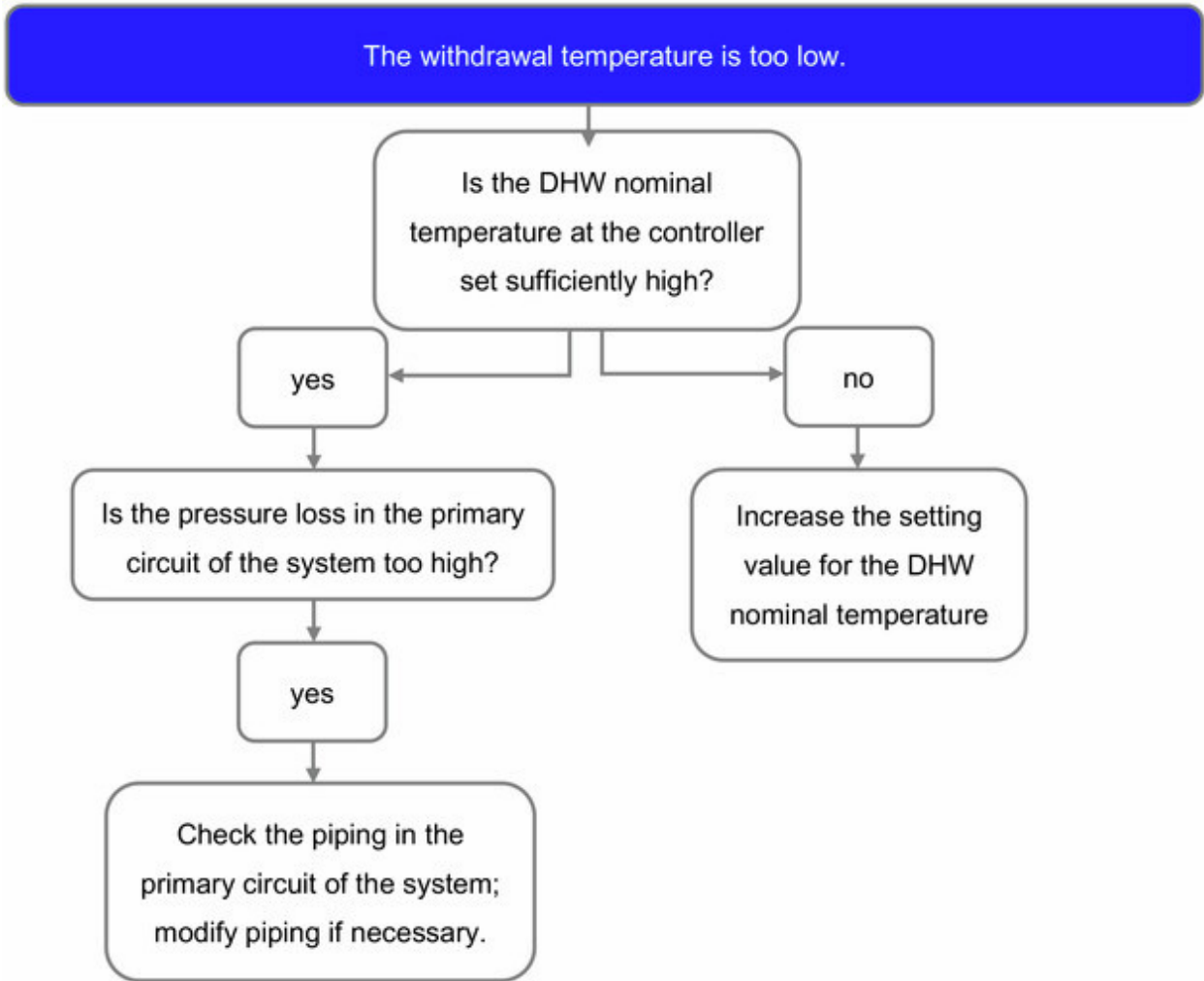

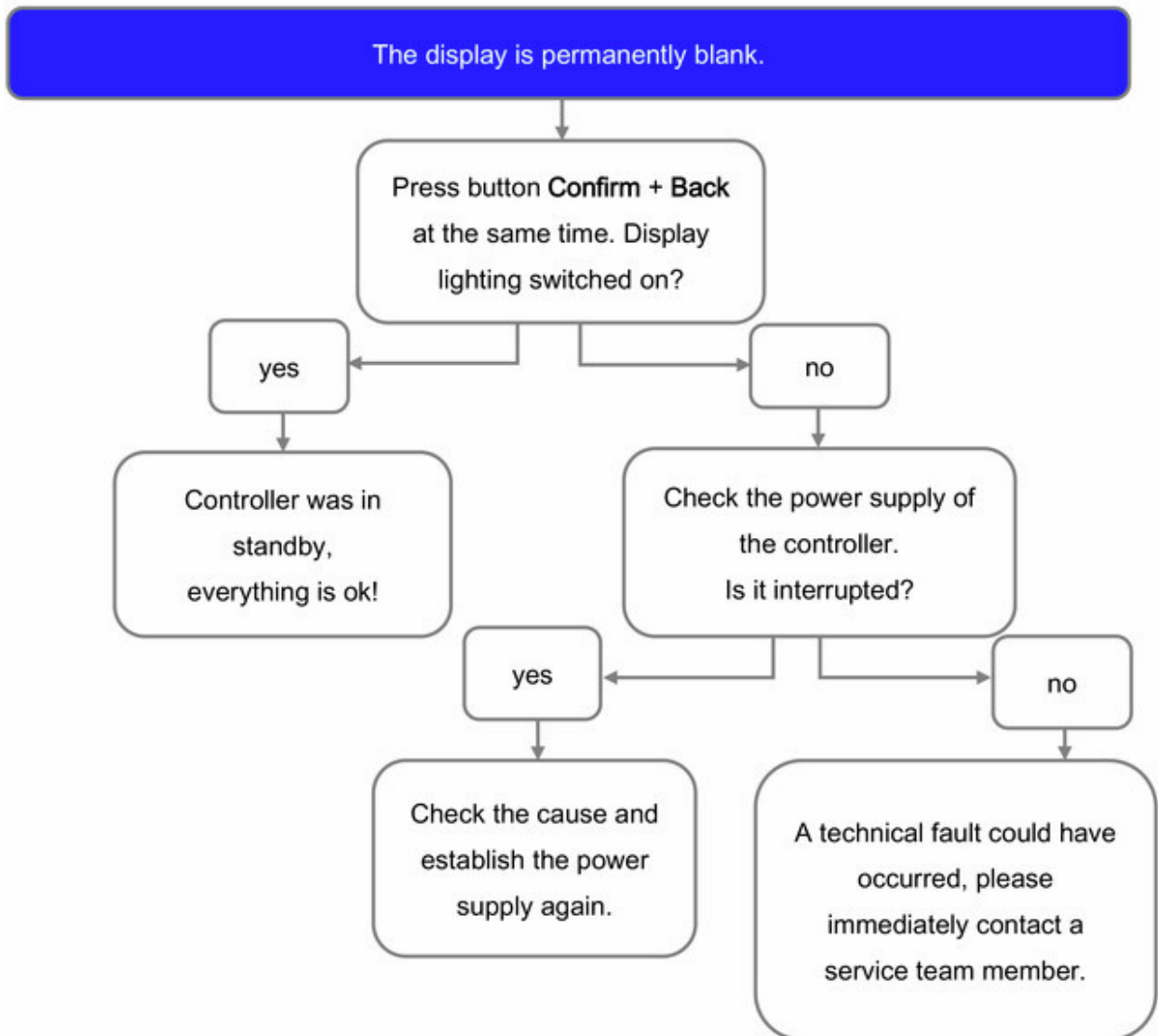

25.3 Checking the VFS 2-40 flow sensor

WARNING	
	<p>Risk to life and limb due to electric shock!</p> <ul style="list-style-type: none"> ▶ Disconnect the controller from the power supply before opening the body. ▶ All work on the open device may only be carried out by professional personnel.

Only for FriwaMini:

1. Remove the front panel.
2. Connect the voltmeter with the plug of the flow sensor at the controller (see illustration on pin assignment).
3. Measure the tension of the flow sensor with a voltmeter and compare it to the following table.
Small deviations are acceptable.
4. After the completed measurement, mount the front panel.

Assignment tension - flow										
Voltage [V]	0.50	0.66	0.82	0.97	1.13	1.29	1.45	1.61	1.76	1.92
Flow [l/min]	2	4	6	8	10	12	14	16	18	20

Voltage [V]	2.08	2.24	2.40	2.55	2.71	2.87	3.03	3.18	3.34	3.50
Flow [l/min]	22	24	26	28	30	32	34	36	38	40

Assignment voltage - temperature										
Voltage [V]	0.50	0.80	1.10	1.40	1.70	2.00	2.30	2.60	2.90	3.20
Temperature [°C]	0	10	20	30	40	50	60	70	80	90

Signal configuration VFS 2-40			
Pin	Designation	Technical description	Cable
1	Temperature signal	0.5 - 3.5 V measured to pin 3	Yellow
2	Flow signal	0.5 - 3.5 V measured to pin 3	White
3	Ground	0 V	Green
4	Power supply	5 V/DC	Brown

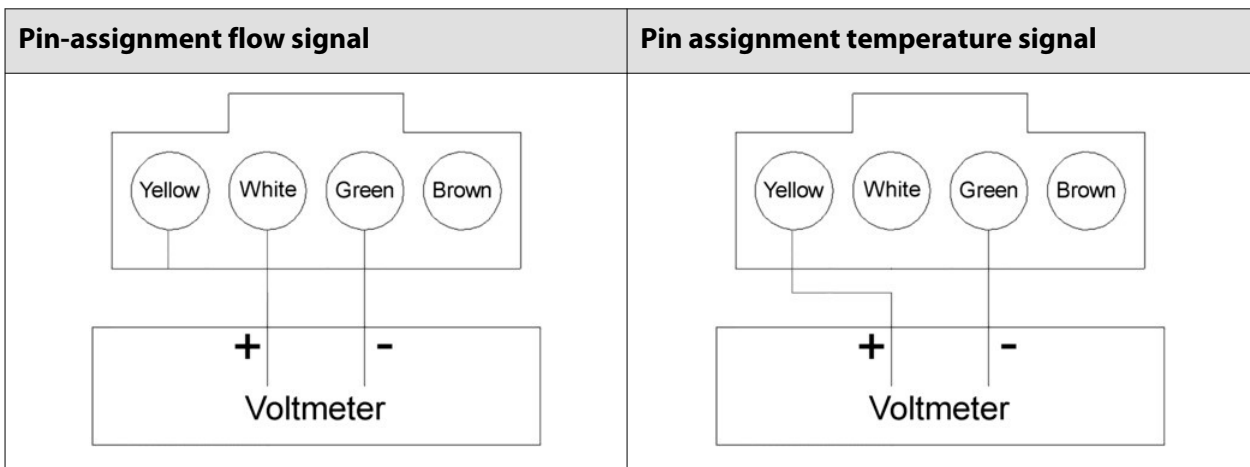

25.4 Checking the FlowSonic flow sensor

WARNING	
	<p>Risk to life and limb due to electric shock!</p> <ul style="list-style-type: none"> ▶ Disconnect the controller from the power supply before opening the body. ▶ All work on the open device may only be carried out by professional personnel.

Only for FriwaMidi, FriwaMaxi, FriwaMega:

1. Remove the front panel.
2. Connect the voltmeter with the plug of the flow sensor at the controller (see illustration on pin assignment).

25 Error correction

3. Measure the tension of the flow sensor with a voltmeter and compare it to the following table.
Small deviations are acceptable.
4. After the completed measurement, mount the front panel.

Assignment tension - flow											
Voltage [V]	0.35	0.38	0.51	0.66	0.82	0.98	1.14	1.29	1.45	1.61	1.77
Flow [l/min]	0 (Standby)	1	5	10	15	20	25	30	35	40	45

Voltage [V]	1.92	2.08	2.24	2.40	2.55	2.71	2.87	3.03	3.18	3.34	3.50
Flow [l/min]	50	55	60	65	70	75	80	85	90	95	100

Signal configuration FlowSonic			
Pin	Designation	Technical description	Cable
1	Temperature signal	Not important for the control	Yellow
2	Flow signal	0.38 - 4.5 V measured to pin 3	White
3	Ground	0 V	Green
4	Power supply	5 V/DC	Brown

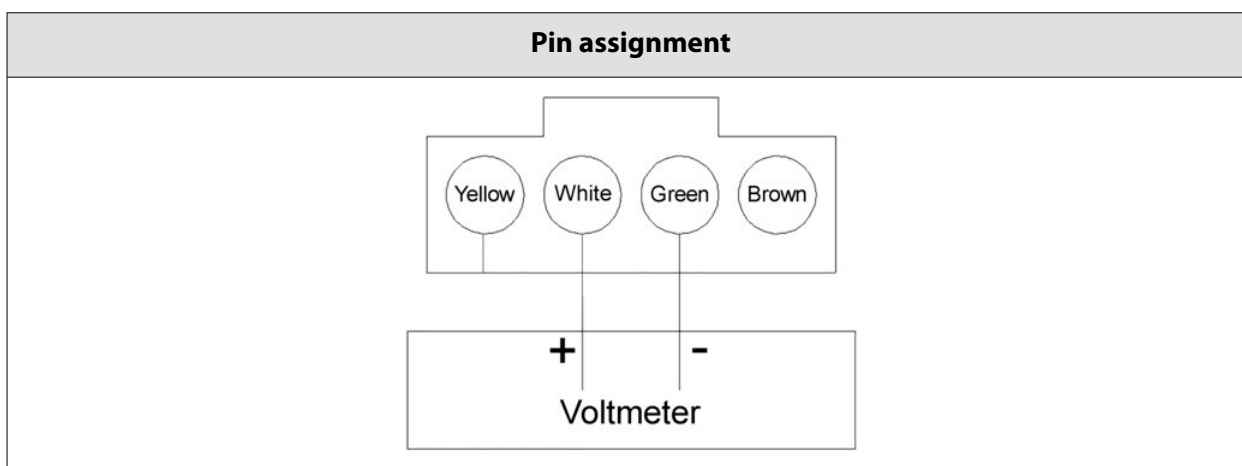

26 Disposal

NOTICE

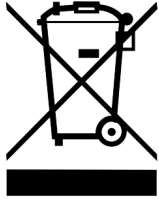

Electrical and electronic devices must not be disposed of in the household waste.

For your return, there are free collection points for electrical appliances and, if necessary, additional points of acceptance for the reuse of the devices in your area.

The addresses can be obtained from your city or communal administration.

If the old electrical or electronic device contains personal data, you are responsible for deleting it before returning the device.

Batteries and rechargeable batteries must be removed prior to the disposal of the product. Depending on the product equipment (partly with optional accessories), single components can also contain batteries and rechargeable batteries.

Please observe the disposal symbols on the components.

Disposal of transport and packaging materials

The packaging materials are made of recyclable materials and can be disposed of with recyclable materials.

27 Exclusion of liability

The manufacturer can neither monitor the compliance with this manual nor the conditions and methods during the installation, operation, usage and maintenance of the controller. Improper installation of the system may result in damage to property and, as a result, to bodily injury.

Therefore, the manufacturer assumes no responsibility and liability for loss, damage or costs which result from or are in any way related to incorrect installation, improper operation, incorrect execution of installation work and incorrect usage and maintenance.

Similarly, we assume no responsibility for patent right or other right infringements of third parties caused by usage of this controller.

The manufacturer reserves the right to make changes to the product, technical data or installation and operating instructions without prior notice.

28 Legal guarantee

In accordance with German statutory regulations, there is a 2-year legal guarantee on this product for the customer. The seller will remove all manufacturing and material faults that occur in the product during the guarantee period and affect the correct functioning of the product. Natural wear and tear do not constitute a malfunction.

No legal guarantee can be offered if the fault can be attributed to third parties, unprofessional installation or commissioning, incorrect or negligent handling, improper transport, excessive loading, use of improper equipment, faulty construction work, unsuitable construction location or improper operation or use. Legal guarantee claims shall only be accepted if notification of the fault is provided immediately after it is discovered. Guarantee claims are to be directed to the seller.

The seller must be informed before guarantee claims are processed.

For processing a guarantee claim an exact fault description and the invoice / delivery note must be provided.

The seller can choose to fulfil the legal guarantee either by repair or replacement. If the product can neither be repaired nor replaced, or if this does not occur within a suitable period in spite of the specification of an extension period in writing by the customer, the reduction in value caused by the fault shall be replaced, or, if this is not sufficient taking the interests of the end customer into consideration, the contract is cancelled.

Any further claims against the seller based on this guarantee obligation, in particular claims for damages due to lost profit, loss-of-use or indirect damages are excluded, unless liability is obligatory by law.



Item no. 99E13331xx-mub-en

Translation of the original instructions

We reserve the right to make technical changes without notice!

Printed in Germany – Copyright by PAW GmbH & Co. KG

PAW GmbH & Co. KG

Böcklerstraße 11

31789 Hameln, Germany

www.paw.eu

Phone: +49-5151-9856-0

Fax: +49-5151-9856-98