

SC5.14



Manual for the
specialised craftsman

Mounting

Connection

Operation

Troubleshooting

Application examples



11204656

Thank you for buying this product.

Please read this manual carefully to get the best performance from this unit. Please keep this manual carefully.

en

Manual

Safety advice

Please pay attention to the following safety advice in order to avoid danger and damage to people and property.

Instructions

Attention must be paid to the valid local standards, regulations and directives!

Information about the product

Proper usage

The solar controller is designed for use in PAW SOLEX systems in compliance with the technical data specified in this manual.

Improper use excludes all liability claims.

CE-Declaration of conformity

The product complies with the relevant directives and is therefore labelled with the CE mark. The Declaration of Conformity is available upon request, please contact the manufacturer.



Note

Strong electromagnetic fields can impair the function of the controller.

- Make sure the controller as well as the system are not exposed to strong electromagnetic fields.

Subject to technical change. Errors excepted.

Target group

These instructions are exclusively addressed to authorised skilled personnel. Only qualified electricians should carry out electrical works. Initial installation must be effected by the system owner or qualified personnel named by the system owner.

Description of symbols

WARNING!

Warnings are indicated with a warning triangle!



→ **They contain information on how to avoid the danger described.**

Signal words describe the danger that may occur, when it is not avoided.

- **WARNING** means that injury, possibly life-threatening injury, can occur.
- **ATTENTION** means that damage to the appliance can occur.



Note

Notes are indicated with an information symbol.

- Arrows indicate instruction steps that should be carried out.

Disposal

- Dispose of the packaging in an environmentally sound manner.
- Dispose of old appliances in an environmentally sound manner. Upon request we will take back your old appliances bought from us and guarantee an environmentally sound disposal of the devices.

Contents

1 Overview	4	9 Arrangement	46
1.1 Optional functions	5	9.1 Optional functions	46
2 Installation	5	10 Heating	56
2.1 Mounting	5	10.1 Demands	56
2.2 Electrical connection	6	10.2 Heating circuits	56
2.3 Data communication / Bus	7	10.3 Optional functions	59
2.4 SD memory card slot	8	11 HQM	63
3 Step-by-step parameterisation	8	12 Basic settings	64
4 Operation and function	9	13 SD card	65
4.1 Buttons	9	14 Manual mode	66
4.2 Selecting menu items and adjusting values	9	15 User code	67
4.3 Menu structure	12	16 In- / Outputs	67
5 Initial commissioning	13	16.1 Modules	67
5.1 Pre-configured SOLEX schemes	15	16.2 Inputs	68
5.2 Basic systems and hydraulic variants	17	16.3 Outputs	69
5.3 Overview of relay and sensor allocation	18	16.4 PWM profiles	70
6 Main menu	28	17 Troubleshooting	71
7 Status	28	18 Accessories	74
7.1 Solar	28	18.1 Sensors and measuring instruments	74
7.2 Arrangement	28	18.2 VBus® accessories	74
7.3 Heating	29	18.3 Interface adapters	76
7.4 Messages	29	19 Index	76
7.5 Meas. / Balance values	30		
7.6 Service	30		
8 Solar	30		
8.1 Basic solar settings	31		
8.2 Solar optional functions	33		
8.3 Function control	45		
8.4 Solar expert menu	46		

1 Overview

- Extra large graphic display
- 5 relay outputs
- 9 (10) inputs for Pt1000, Pt500 or KTY temperature sensors
- 1 input for a FlowRotor
- 1 input for an analogue Grundfos Direct Sensors™ or an electronic pressure gauge
- 4 PWM outputs for speed control of high-efficiency pumps
- Datalogging / firmware updates via SD memory card
- Selectable system schemes for PAW SOLEX
- Pre-programmed optional functions
- Drainback option
- Time-controlled thermostat function
- Thermal disinfection
- Automatic function control according to VDI 2169
- VBus®
- Energy-saving switch-mode power supply

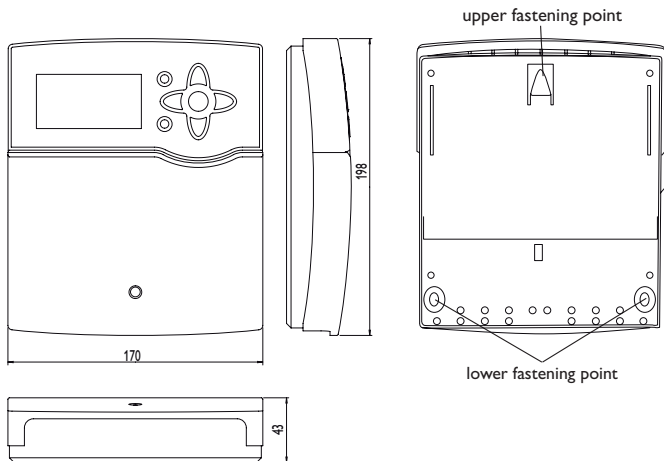

Technical data

Housing: plastic, PC-ABS and PMMA

Protection type: IP 20/EN 60529

Protection class: I

Ambient temp.: 0 ... 40 °C

Dimensions: 198 × 170 × 43 mm

Mounting: wall mounting, also suitable for mounting into patch panels

Display:

Full graphic display, control lamp (directional pad) and background illumination

Operation: 7 push buttons at the front of the housing

Functions: ΔT control, pump speed control, heat quantity measurement, operating hours counter for the solar pump, tube collector function, antifreeze function, thermostat function, store loading in layers, weather-compensated heating circuit control, priority logic, drainback option, booster function, heat dump function, thermal disinfection function, PWM pump control, automatic function control according to VDI 2169.

Inputs: 9 (10) inputs for Pt1000, Pt500 or KTY temperature sensors (7 of them can optionally be used for RTA11-M remote controls), 1 V40 impulse input, input for 1 analogue Grundfos Direct Sensor™ or 1 electronic pressure gauge 1 CS10 irradiation sensor, 1 FlowRotor

Outputs: 4 semiconductor relays, 1 potential-free relay, 4 PWM outputs (switchable to 0-10 V)

Data interfaces: VBus®, SD card slot

Power supply: 100 ... 240 V~, 50 ... 60 Hz

Switching capacity per relay:

1 (1) A 100 ... 240 V~ (semiconductor relay)

4 (2) A 100 ... 240 V~ (potential-free relay)

Total switching capacity: 4 A

Standby power consumption: < 1W

Mode of operation: type 1.Y

Degree of pollution: 2

Rated impulse voltage: 2.5 kV

Supply connection: type Y attachment

1.1 Optional functions

Solar

Bypass
CS-Bypass
External heat exchanger
Tube collector
Target temperature
Frost protection
Afterheating suppression
Parallel relay
Cooling mode
Drainback
Twin pump
Heat dump
Flow rate monitoring
Pressure monitoring

Arrangement

Parallel relay
Mixer
Store loading
Error relay
Heat exchange
Solid fuel boiler
Circulation
Return preheating
Function block
Irradiation switch

Heating

Thermal disinfection
DHW heating

2 Installation

2.1 Mounting

The unit must only be located in dry interior rooms.

The controller must additionally be supplied from a double pole switch with contact gap of at least 3 mm.

Please pay attention to separate routing of sensor cables and mains cables.

In order to mount the device to the wall, carry out the following steps:

- Unscrew the cross-head screw from the cover and remove it along with the cover from the housing.
- Mark the upper fastening point on the wall. Drill and fasten the enclosed wall plug and screw leaving the head protruding.
- Hang the housing from the upper fastening point and mark the lower fastening points (centres 150 mm).
- Insert lower wall plugs.
- Fasten the housing to the wall with the lower fastening screws and tighten.
- Carry out the electrical wiring in accordance with the terminal allocation, (see page 6).
- Put the cover on the housing.
- Attach with the fastening screw.

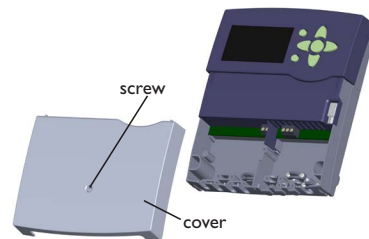

Note

Strong electromagnetic fields can impair the function of the controller. Make sure the controller as well as the system are not exposed to strong electromagnetic fields.

WARNING! Electric shock!



Upon opening the housing, live parts are exposed!

→ **Always disconnect the controller from power supply before opening the housing!**

2.2 Electrical connection



Note:

Connecting the device to the power supply must always be the last step of the installation!

The controller is equipped with 5 **relays** in total to which loads such as pumps, valves, etc. can be connected:

Relays 1 ... 4 are semiconductor relays, designed for pump speed control.

Conductor R1... R4

Neutral conductor N (common terminal block)

Protective earth conductor PE \oplus (common terminal block)

Relay 5 is a potential-free relay:

Connections to the R5 terminals can be made with either polarity.

WARNING! ESD damage!



Electrostatic discharge can lead to damage to electronic components!

→ **Take care to discharge properly before touching the inside of the device! To do so, touch a grounded surface such as a radiator or tap!**



Note:

The pump speed must be set to 100% when non-speed-controlled devices such as valves are connected.

WARNING! Electric shock!



Upon opening the housing, live parts are exposed!

→ **Always disconnect the controller from power supply before opening the housing!**



Note

For more details about the initial commissioning procedure see page 13.

Depending on the product version, mains cables and sensor cables are already connected to the device. If that is not the case, please proceed as follows:

Temperature sensors (S1 to S9) have to be connected to the terminals S1...S9 and GND (either polarity).

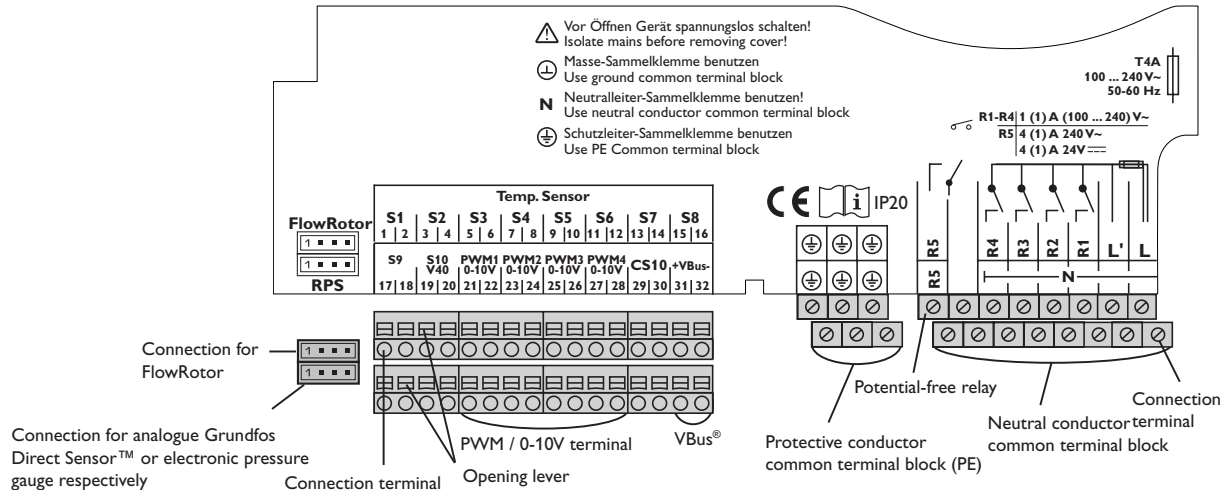

The S10 terminal is an impulse input for a V40 flowmeter or an FS08 flow switch. A V40 flowmeter can be connected to the terminals S1 / V40 and GND (either polarity).

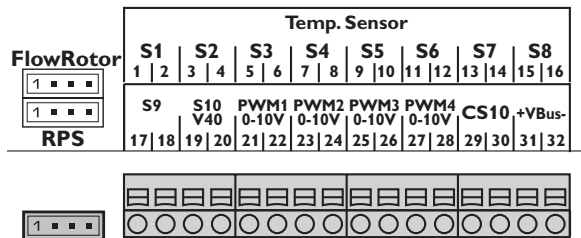

Connect the irradiation sensor **CS10** to the terminals CS10 and GND with correct polarity. To do so, connect the cable marked GND to the GND common terminal block, the cable marked CS to the terminal marked CS10.

The terminals marked PWM1...4 contain the 2 PWM- / 0-10-V speed control signal outputs for high-efficiency pumps.

Note:
If a relay is to be allocated to a PWM / 0-10 V output, carry out the following adjustment in the In- / Outputs menu:

1. PWM / 0-10 V output: selection output = PWM1
2. PWM / 0-10 V output: selection output = PWM2
3. PWM / 0-10 V output: selection output = PWM3
4. PWM / 0-10 V output: selection output = PWM4

Connect the **FlowRotor** to the input marked FlowRotor. Connect **analogue Grundfos Direct Sensor™** or the **electronic pressure gauge** to the input marked RPS.

Note:
When Grundfos Direct Sensors™ are used, the sensor ground common terminal block must be connected to PE.

The controller is supplied with power via a mains cable. The power supply of the device must be 100...240V~ (50...60 Hz).

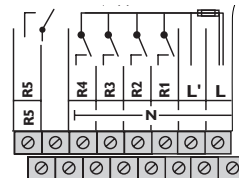

The mains connection is at the terminals:

Neutral conductor N

Conductor L

Conductor L' (L' is not connected with the mains cable. L' is a fused contact permanently carrying voltage.)

Protective earth conductor PE (⊕) (common terminal block)

2.3 Data communication / Bus

The controller is equipped with a VBus® or data transfer with and energy supply to external modules. The connection is to be carried out at the two terminals marked VBus and GND (any polarity). One or more VBus® modules can be connected via this data bus, such as:

- GA3 Large Display module / SD3 Smart Display
- AM1 Alarm Module
- DL2 Datalogger
- EM Extension module

Furthermore, the controller can be connected to a PC via the VBus®/USB or VBus®/LAN interface adapter (not included). With the ServiceCenter Software, measured values can be read, processed and visualised. The software allows an easy function control of the system.

Parameterising the controller via the ServiceCenter software is not possible at the moment. This feature will be made available in a later version of the RPT configuration tool.

Note:
More accessories on page 74.

WARNING! Electric shock!



L' is a fused contact permanently carrying voltage.)

➔ Always disconnect the controller from power supply before opening the housing!

2.4 SD memory card slot

The controller is equipped with an SD card slot.

With an SD card, the following functions can be carried out:

- Store measurement and balance values onto the SD card. After the transfer to a computer, the values can be opened and visualised, e. g. in a spreadsheet.
- Prepare adjustments and parameterisations on a computer and transfer them via the SD card.
- Store adjustments and parameterisations on the SD card and, if necessary, retrieve them from there.
- Download firmware updates from the Internet and install them on the controller.

For more information about using an SD card, see page 65.



3 Step-by-step parameterisation

The SC5.14 controller is a controller that offers a broad variety of functions to the user. At the same time, the user has a lot of freedom in configuring them. Therefore, to set up a complex system, careful planning is required. We recommend drawing a sketch of the system first.

If planning, hydraulic execution and electrical connection have all been carried out successfully, proceed as follows:

1. Running the commissioning menu

The commissioning menu is run after the first connection and after every reset. It will request the following basic adjustments:

- Menu language
- Temperature unit
- Volume unit
- Pressure unit
- Energy unit
- Time
- Date
- Solar system
- Hydraulic variant

At the end of the commissioning menu, a safety enquiry follows. If the safety enquiry is confirmed, the adjustments will be saved.

For further information about the commissioning menu see page 13.

2. Registering sensors

If flowmeters, flow switches, Grundfos Direct Sensors™ and/or external extension modules are connected, these have to be registered in the In-/Outputs menu.

For further information about the registration of modules and sensors see page 67.

3. Activating solar optional functions

The basic solar system has been adjusted during commissioning. Now, optional functions can be selected, activated and adjusted.

Free relays can be allocated to optional functions which require a relay. The controller always suggests the numerically smallest free relay.

Sensors can be allocated to more than one function.

For further information about the optional arrangement functions see page 33.

4. Activating optional arrangement functions

Now, optional functions for the non-solar part of the arrangement can be selected, activated and adjusted.

Free relays can be allocated to optional functions which require a relay. The controller always suggests the numerically smallest free relay.

Sensors can be allocated to more than one function.

For further information about the optional arrangement functions see page 46.

5. Adjusting heating circuits and activating optional heating functions

Now, heating circuits can be activated and adjusted.

For the heating part of the arrangement, optional functions can be selected, activated and adjusted.

To heating circuits and optional functions which require one or more relays, the corresponding number of free relays can be allocated. The controller always suggests the numerically smallest free relay.

Sensors can be allocated to more than one function.

For further information about heating circuits and optional heating functions see page 56.

4 Operation and function

4.1 Buttons

The controller is operated via the 7 buttons next to the display. They have the following functions:

button 1 - scrolling upwards

button 3 - scrolling downwards

button 2 - increasing adjustment values

button 4 - reducing adjustment values

button 5 - confirming

button 6 - entering the status menu / chimney sweeper mode (system-dependent)

button 7 - escape button for changing into the previous menu

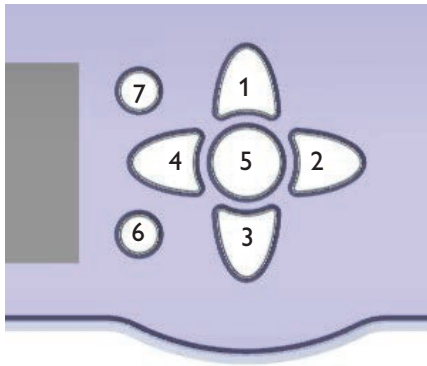

4.2 Selecting menu items and adjusting values

During normal operation of the controller, the display is in the main menu. If no button is pressed for a few seconds, the display illumination goes out.

Press any key to reactivate the display illumination.

→ In order to scroll through a menu or to adjust a value, press either buttons 1 and 3 or buttons 2 and 4.

→ To open a sub-menu or to confirm a value, press button 5.

→ To enter the status menu, press button 6 – unconfirmed adjustments will not be saved.

→ To switch to the previous menu level, press button 7 – unconfirmed adjustments will not be saved.

If no button has been pressed within a couple of minutes, the adjustment is cancelled and the previous value is retained.

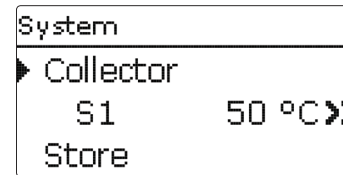

If the symbol » is shown behind a menu item, pressing button 5 will open a new sub-menu.

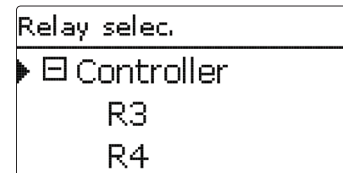

If the symbol ⊞ is shown in front of a menu item, pressing button 5 will open a new sub-menu. If it is already opened, a ⊞ is shown instead of the ⊞.

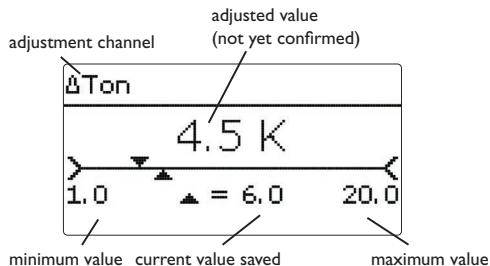

Values and adjustments can be changed in different ways:

Numeric values can be adjusted by means of a slide bar. The minimum value is indicated to the left, the maximum value to the right. The large number above the slide bar indicates the current adjustment. By pressing buttons **2** and **4** the upper slide bar can be moved to the left or to the right.

Only after the adjustment has been confirmed by pressing button **5** will the number below the slide bar indicate the new value. The new value will be saved if it is confirmed by pressing button **5** again.

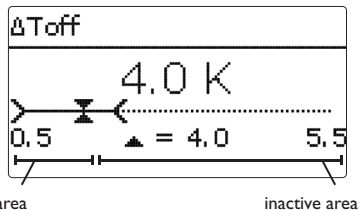

When two values are locked against each other, they will display a reduced adjustment range depending on the adjustment of the respective other value.

In this case, the active area of the slide bar is shortened, the inactive area is indicated as a dotted line. The indication of the minimum and maximum values will adapt to the reduction.

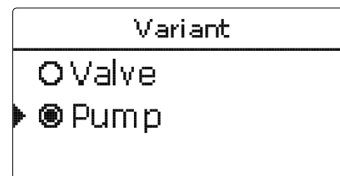

If only one item of several can be selected, they will be indicated with "radio buttons". When one item has been selected, the radio button in front of it is filled.

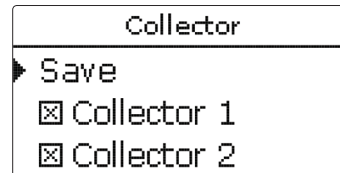

If more than one item of several can be selected, they will be indicated with checkboxes. When an item has been selected, an x appears inside the checkbox.

Adjusting the timer

When the **Timer** option is activated, a timer is indicated in which time frames for the function can be adjusted.

First of all, an overview of the current adjustments is displayed. For each day of the week there is an overview display. The display can be switched back and forth between the different days by pressing buttons **2** and **4**.

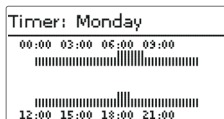

In order to adjust the timer, press button **3**.

First the individual days of the week or all days of the week can be selected.

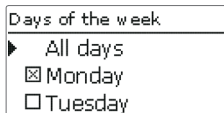

The last menu item after the list of days is **Continue**. If Continue is selected, the **Edit timer** menu opens, in which the time frames can be adjusted.



Adding a time frame:

The time frames can be adjusted in steps of 15 min. In order to add an active time frame, proceed as follows:

➔ Move the cursor to the desired starting point of the time frame by pressing buttons **2** and **4**. Confirm the starting point of the time frame by pressing button **1**.

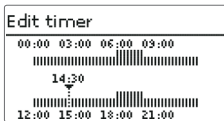

➔ Move the cursor to the desired ending point of the time frame by pressing buttons **2** and **4**.

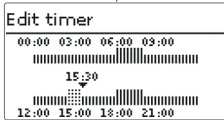

- ➔ The end of a time frame can be determined by pressing button **5**.
- ➔ In order to add another time frame, repeat the last three steps.
- ➔ Press button **5** again to get back to the overview of current adjustments.

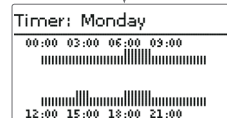
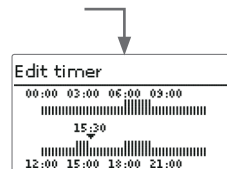

Removing a time frame:

In order to remove an active time frame, proceed as follows:

- ➔ Determine the point from which on the time frame is to be removed by pressing button **7**.

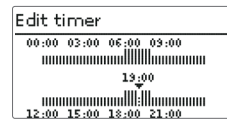

- ➔ Move the cursor to the desired ending point of the time frame by pressing buttons **2** and **4**.

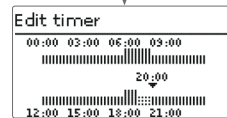

- ➔ In order to conclude removing the time frame, press button **5** upon reaching the desired ending point.

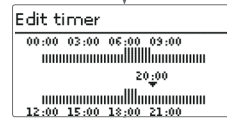

- ➔ Press button **5** again to get back to the overview of current adjustments.

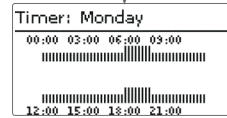

4.3 Menu structure

Main menu

Status

Solar

Arrangement

Heating

HQM

Basic settings

SD card

Manual mode

User code

In- / Outputs

Expert

Solar

Basic setting

Optional functions

Function control

Expert

Arrangement

Optional functions

Heating

Demands

Heating circuits

Optional functions

Basic settings

Language

Auto DST

Date

Time

Temp. unit

Vol. unit

...

In- / Outputs

Modules

Inputs

Outputs

Basic setting

System

Collector

Store

Loading logic

Optional functions

Parallel relay

Mixer

Store loading

Error relay

...

Parallel relay

Relay

Reference relay

Overrun

Delay

Inverted

...

The menu items and adjustment values selectable are variable depending on adjustments already made. The figure only shows an exemplary excerpt of the complete menu in order to visualise the menu structure.

5 Initial commissioning

When the hydraulic system is filled and ready for operation, connect the controller to the mains.

The controller runs an initialisation phase in which the directional pad flashes red. When the controller is commissioned for the first time or when it is reset, it will run a commissioning menu after the initialisation phase. The commissioning menu leads the user through the most important adjustment channels needed for operating the system.

Commissioning menu

The commissioning menu consists of the channels described in the following. In order to make an adjustment, push button **5**. Adjust the value by pressing buttons **2** and **4**, then push button **5** to confirm. The next channel will appear in the display.

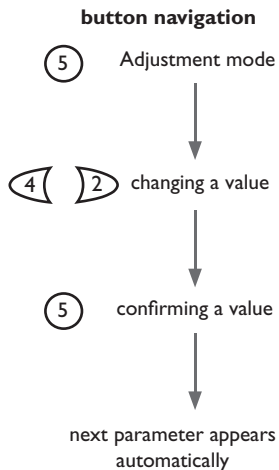

1. Language:

→ Adjust the desired menu language.

2. Scheme:

→ Adjust the scheme number according to page 15.

3. Units:

→ Adjust the desired temperature unit.

→ Adjust the desired volume unit.

→ Adjust the desired pressure unit.

→ Adjust the desired energy unit.

4. Daylight savings time adjustment:

→ Activate or deactivate the automatical daylight savings time adjustment.

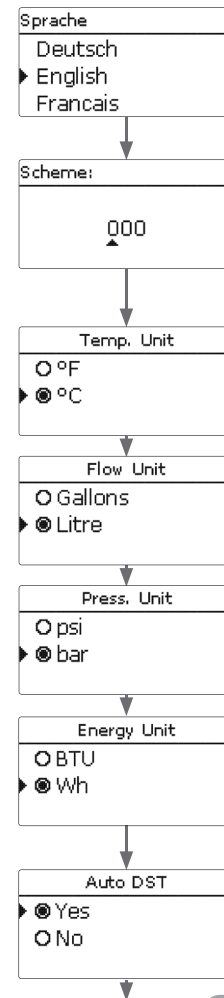

5. Time:

- Adjust the clock time. First of all adjust the hours, then the minutes.

Time
08:29

6. Date:

- Adjust the date. First of all adjust the year, then the month and then the day.

Date
??.??.2014

7. Selection of the solar system:

- Adjust the desired solar system (number of collectors and stores, hydraulic variants).

System
6.2



Note:

This step will be skipped when a scheme number has been entered.

8. Completing the commissioning menu:

After the system has been selected, a safety enquiry appears. If the safety enquiry is confirmed, the adjustments will be saved.

- In order to confirm the safety enquiry, press button (5).
- In order to reenter the commissioning menu channels, press button (7). If the safety enquiry has been confirmed, the controller is ready for operation and should enable an optimum system operation.

All adjustments made during commissioning can, if necessary, be changed later on in the **Basic settings** menu.

System
Save Yes

5.1 Pre-configured SOLEX schemes

SOLEX 1 = Scheme 881

(In order to select this scheme, enter scheme number 881)

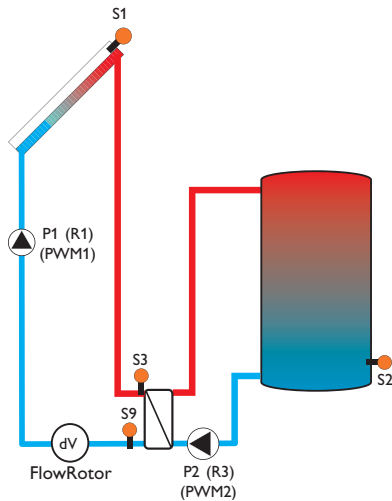
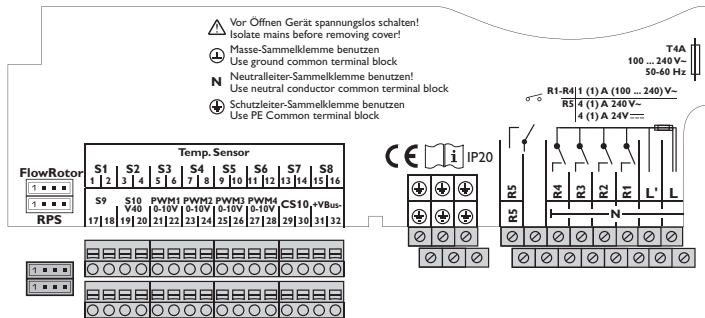

Relay / sensor allocation

Connection terminal	Description	Indication
PWM1	Primary pump Speed control signal	Primary pump
PWM2	Secondary pump Speed control signal	Sec.ExtHX 1
S1	Collector sensor	Collector/ Flow HQM 1
S2	Store sensor	Store 1
S3	Heat exchanger sensor	ExtHX: Primary 1
S9	Return sensor	Return HQM 1
FlowRotor	Flow rate sensor	FlowRotor
R1	Primary pump Power supply	
R3	Secondary pump Power supply	

Functions

Function	Factory setting	Sensors
External heat exchanger, solar	yes	S3
Flow rate monitoring	yes	FlowRotor
Heat quantity measurement	yes	S3, S9, FlowRotor
Heat transfer fluid	Tyfofor LS	

SOLEX 2 = Scheme 882

(In order to select this scheme, enter scheme number 882)

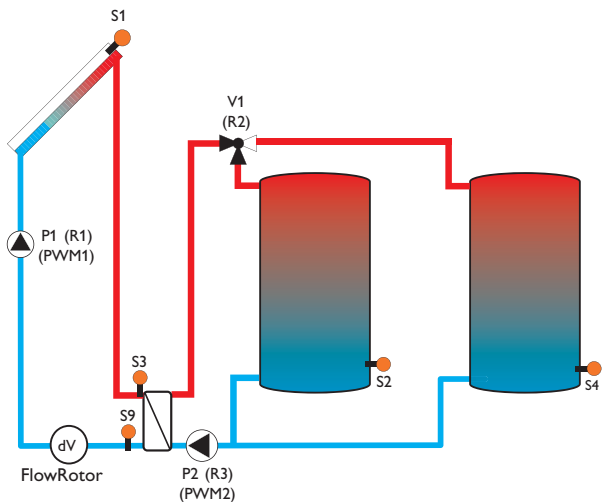
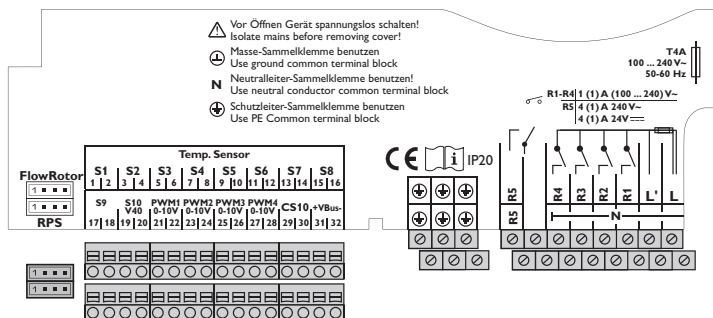

Relay / sensor allocation

Connection terminal	Description	Indication
PWM1	Primary pump Speed control signal	Primary pump
PWM2	Secondary pump Speed control signal	Sec.ExtHX 1
S1	Collector sensor	Collector/ Flow HQM 1
S2	Store sensor	Store 1
S4	Store sensor 2	Store 2
S3	Heat exchanger sensor	ExtHX: Primary 1
S9	Return sensor	Return HQM 1
FlowRotor	Flow rate sensor	FlowRotor
R1	Primary pump Power supply	
R2	3-port changeover valve	3PV store 2
R3	Secondary pump Power supply	

Functions

Function	Factory setting	Sensors
External heat exchanger, solar	yes	S3
Flow rate monitoring	yes	FlowRotor
Heat quantity measurement	yes	S3, S9, FlowRotor
Heat transfer fluid	Tyfocor LS	

5.2 Basic systems and hydraulic variants

System

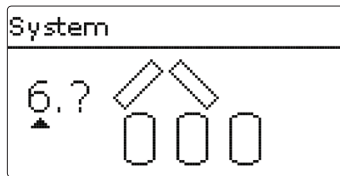

In addition to the pre-configured schemes 881 and 882, the controller is pre-programmed for 7 basic solar systems. The selection depends on the number of heat sources (collector fields) and heat sinks (stores, pool). Factory setting is system 1. The selection of the basic solar system is one of the most important adjustments and is thus requested already in the commissioning menu.

First, the basic system is adjusted by means of the number of stores and collectors fields, then the hydraulic variant.

The selected system is visualised by the corresponding number of store and collector symbols. The figure to the left shows system 6 which consists of 3 stores and 2 collector fields ("east- / west collectors").

Variant

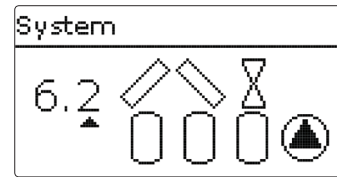

The hydraulic variant refers to the different actuators that are to be controlled. They are visualised on the display by means of symbols, when the variant is selected. The upper symbol indicates the actuator belonging to the collector fields, the lower one the actuators belonging to the stores.

The exemplary figure shows the display indicated when system 6, variant 2 has been selected. In this case, each collector field has a 2-port valve, the stores are loaded by means of pump logic.

For each variant, the controller allocates the corresponding relays and sensors. The allocations of all combinations are shown in chap. 5.3.

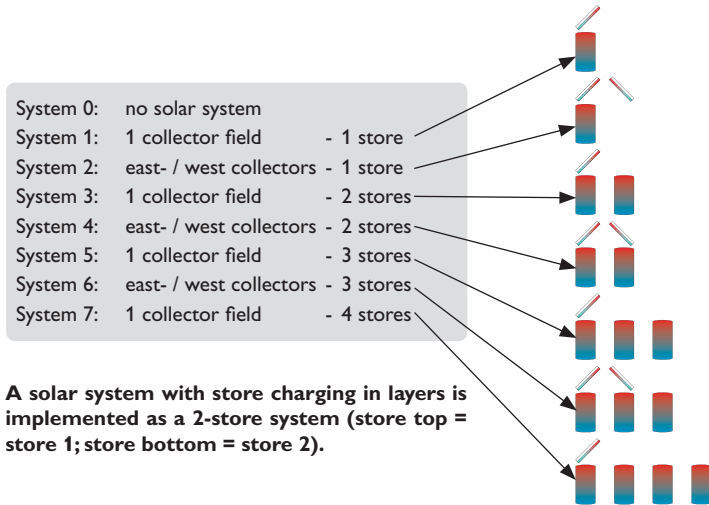

A solar system with store charging in layers is implemented as a 2-store system (store top = store 1; store bottom = store 2).

5.3 Overview of relay and sensor allocation

System 1

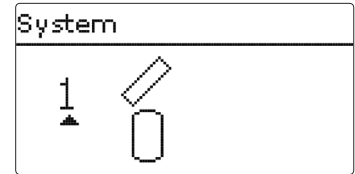
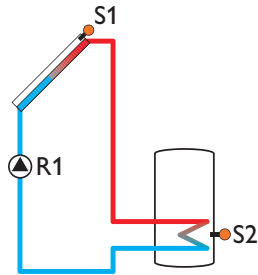

Relay / sensor allocation

	1	2	3	4	5	6	7	8	9
Relay	Solar pump	Optional function	Optional function	Optional function	Optional function				
Sensor	Collector 1	Store base	Free	Free	Free	Free	Free	Free	Free

System 2 variant 1

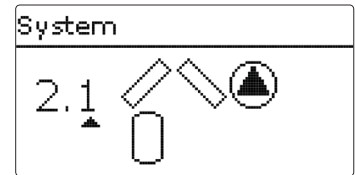
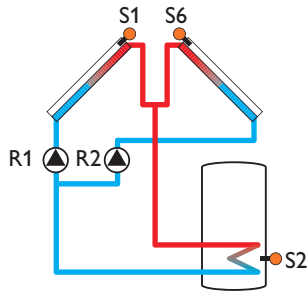

Relay / sensor allocation

	1	2	3	4	5	6	7	8	9
Relay	Pump coll. 1	Pump coll. 2	Optional function	Optional function	Optional function				
Sensor	Collector 1	Store base	Free	Free	Free	Collector 2	Free	Free	Free

System 2 variant 2

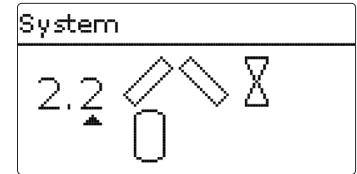
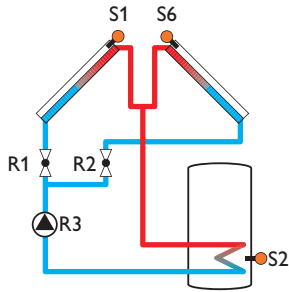

Relay / sensor allocation

	1	2	3	4	5	6	7	8	9
Relay	2PV coll. 1	2PV coll. 2	Solar pump	Optional function	Optional function				
Sensor	Collector 1	Store base	Free	Free	Free	Collector 2	Free	Free	Free

System 3 variant 1

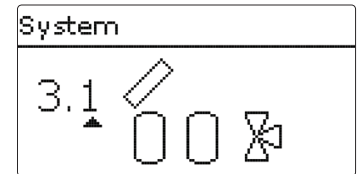
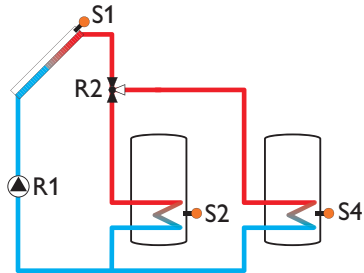

Relay / sensor allocation

	1	2	3	4	5	6	7	8	9
Relay	Solar pump	3PV Store 2	Optional function	Optional function	Optional function				
Sensor	Collector	Store 1 base	Free	Store 2 base	Free	Free	Free	Free	Free

System 3 variant 2

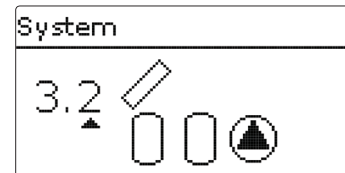
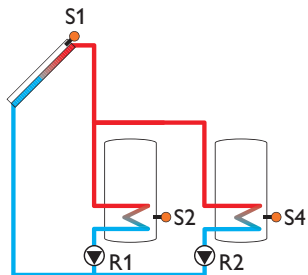

Relay / sensor allocation

	1	2	3	4	5	6	7	8	9
Relay	Solar pump Store 1	Solar pump Store 2	Optional function	Optional function	Optional function				
Sensor	Collector	Store 1 base	Free	Store 2 base	Free	Free	Free	Free	Free

System 3 variant 3

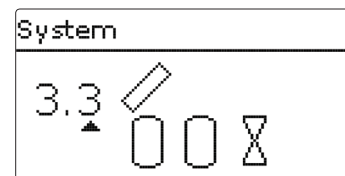
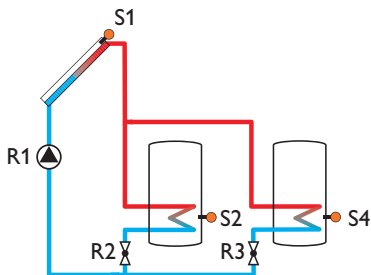

Relay / sensor allocation

	1	2	3	4	5	6	7	8	9
Relay	Solar pump	2PV Store 1	2PV Store 2	Optional function	Optional function				
Sensor	Collector	Store 1 base	Free	Store 2 base	Free	Free	Free	Free	Free

System 4 variant 1

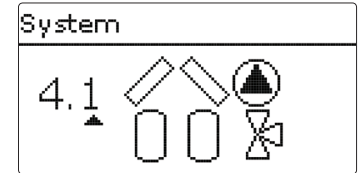
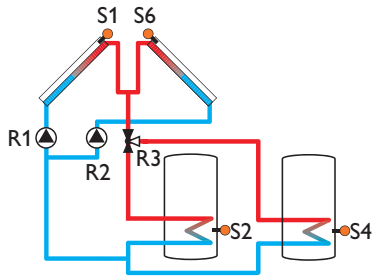

Relay / sensor allocation

	1	2	3	4	5	6	7	8	9
Relay	Pump coll. 1	Pump coll. 2	3PV Store 2	Optional function	Optional function				
Sensor	Collector 1	Store 1 base	Free	Store 2 base	Free	Collector 2	Free	Free	Free

System 4 variant 2

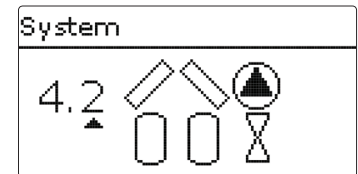
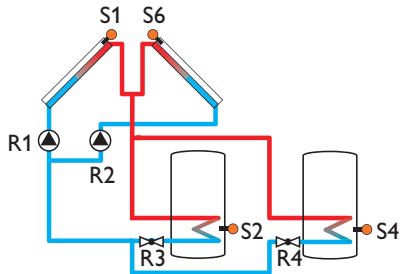

Relay / sensor allocation

	1	2	3	4	5	6	7	8	9
Relay	Pump coll. 1	Pump coll. 2	2PV Store 1	2PV Store 2	Optional function				
Sensor	Collector 1	Store 1 base	Free	Store 2 base	Free	Collector 2	Free	Free	Free

System 4 variant 3

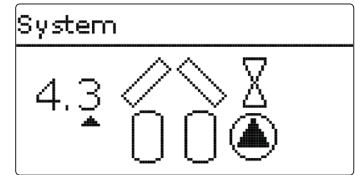
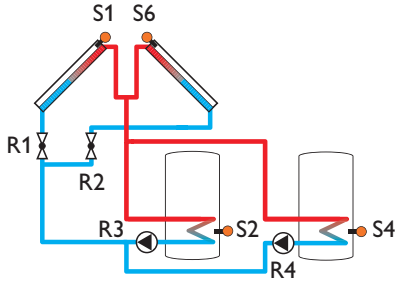

Relay / sensor allocation

	1	2	3	4	5	6	7	8	9
Relay	2PV coll. 1	2PV coll. 2	Solar pump store 1	Solar pump store 2	Optional function				
Sensor	Collector 1	Store 1 base	Free	Store 2 base	Free	Collector 2	Free	Free	Free

System 4 variant 4

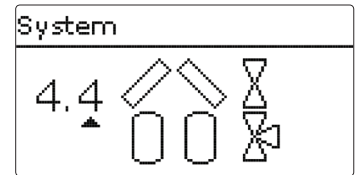
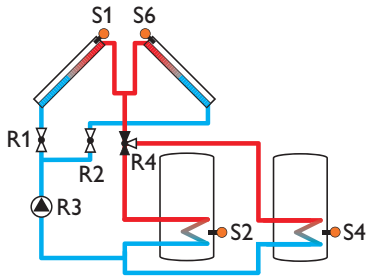

Relay / sensor allocation

	1	2	3	4	5	6	7	8	9
Relay	2PV coll. 1	2PV coll. 2	Solar pump	3PV Store 1	Optional function				
Sensor	Collector 1	Store 1 base	Free	Store 2 base	Free	Collector 2	Free	Free	Free

System 5 variant 1

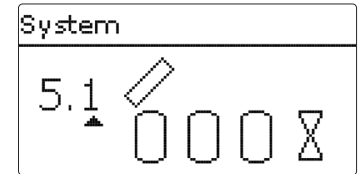
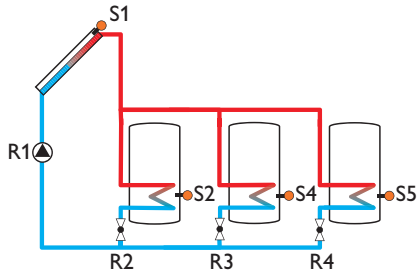

Relay / sensor allocation

	1	2	3	4	5	6	7	8	9
Relay	Solar pump	2PV Store 1	2PV Store 2	2PV Store 3	Optional function				
Sensor	Collector 1	Store 1 base	Free	Store 2 base	Store 3 base	Free	Free	Free	Free

System 5 variant 2

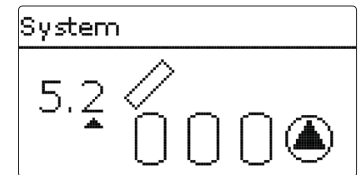
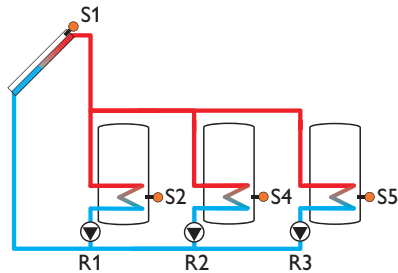

Relay / sensor allocation

	1	2	3	4	5	6	7	8	9
Relay	Solar pump store 1	Solar pump store 2	Solar pump store 3	Optional function	Optional function				
Sensor	Collector 1	Store 1 base	Free	Store 2 base	Store 3 base	Free	Free	Free	Free

System 5 variant 3

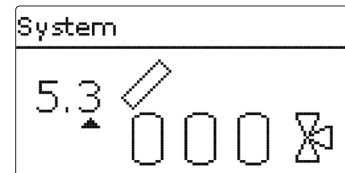
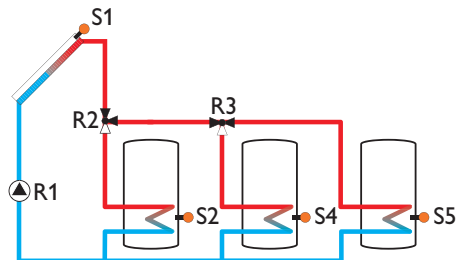

Relay / sensor allocation

	1	2	3	4	5	6	7	8	9
Relay	Solar pump	3PV Store 1	3PV Store 2	Optional function	Optional function				
Sensor	Collector 1	Store 1 base	Free	Store 2 base	Store 3 base	Free	Free	Free	Free

System 6 variant 1

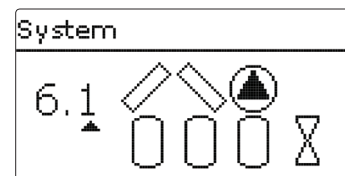
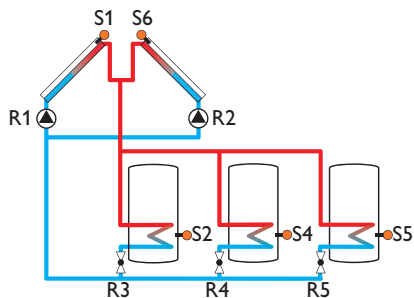

Relay / sensor allocation

	1	2	3	4	5	6	7	8	9
Relay	Pump coll. 1	Pump coll. 2	2 PV store 1	2 PV store 2	2 PV store 3				
Sensor	Collector 1	Store 1 base	Free	Store 2 base	Store 3 base	Collector 2	Free	Free	Free

System 6 variant 2

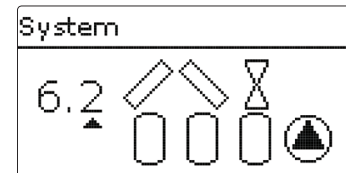
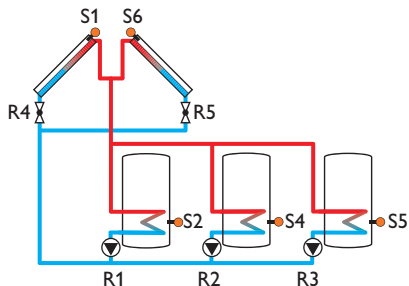

Relay / sensor allocation

	1	2	3	4	5	6	7	8	9
Relay	Solar pump store 1	Solar pump store 2	Solar pump store 3	2PV coll. 1	2PV coll. 2				
Sensor	Collector 1	Store 1 base	Free	Store 2 base	Store 3 base	Collector 2	Free	Free	Free

System 6 variant 3

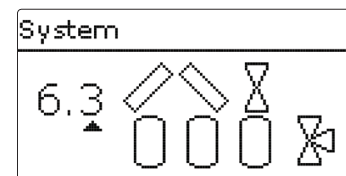
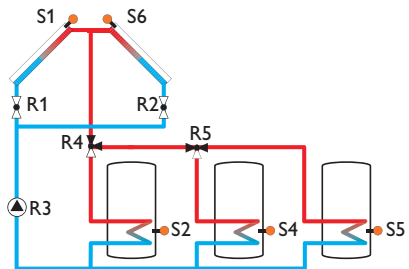

Relay / sensor allocation

	1	2	3	4	5	6	7	8	9
Relay	2PV coll. 1	2PV coll. 2	Solar pump	3PV Store 1	3PV Store 2				
Sensor	Collector 1	Store 1 base	Free	Store 2 base	Store 3 base	Collector 2	Free	Free	Free

System 6 variant 4

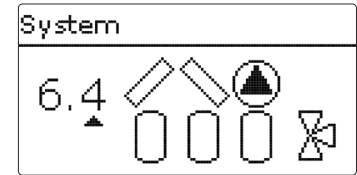
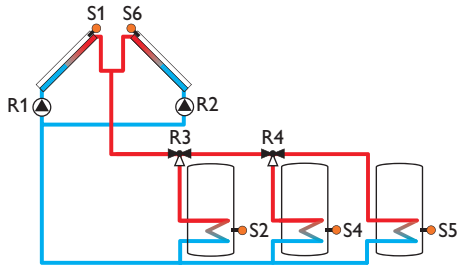

Relay / sensor allocation

	1	2	3	4	5	6	7	8	9
Relay	Pump coll. 1	Pump coll. 2	3 PV store 1	3 PV store 2	Optional function				
Sensor	Collector 1	Store 1 base	Free	Store 2 base	Store 3 base	Collector 2	Free	Free	Free

System 7 variant 1

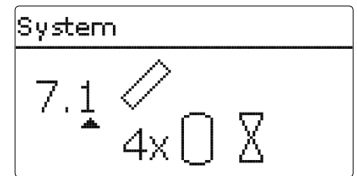
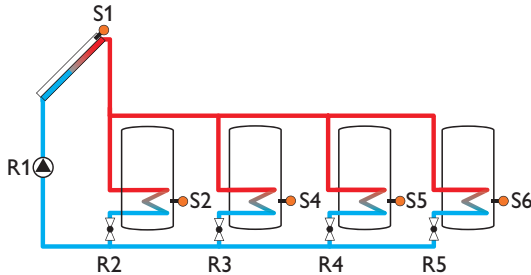

Relay / sensor allocation

	1	2	3	4	5	6	7	8	9
Relay	Solar pump	2PV Store 1	2PV Store 2	2PV Store 3	2PV Store 4				
Sensor	Collector 1	Store 1 base	Free	Store 2 base	Store 3 base	Store 4 base	Free	Free	Free

System 7 variant 2

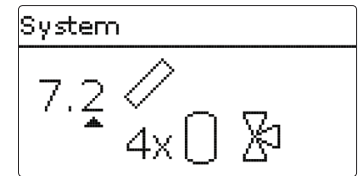
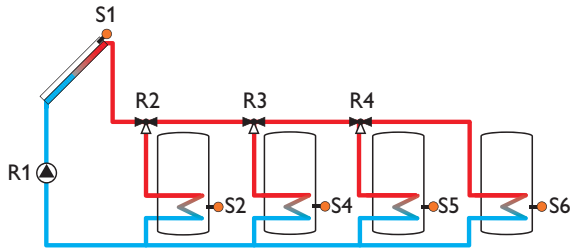

Relay / sensor allocation

	1	2	3	4	5	6	7	8	9
Relay	Solar pump	3PV Store 1	3PV Store 2	3PV Store 3	Optional function				
Sensor	Collector 1	Store 1 base	Free	Store 2 base	Store 3 base	Store 4 base	Free	Free	Free

System 7 variant 3

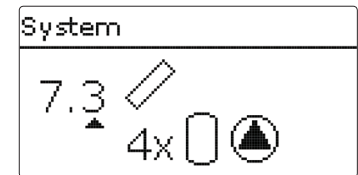
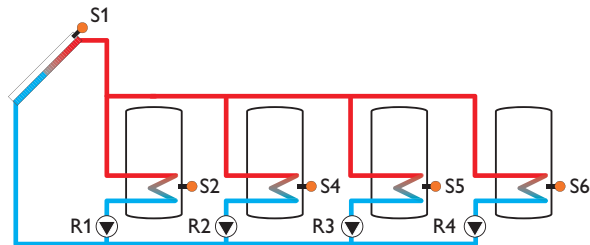

Relay / sensor allocation

	1	2	3	4	5	6	7	8	9
Relay	Solar pump store 1	Solar pump store 2	Solar pump store 3	Solar pump store 4	Optional function				
Sensor	Collector 1	Store 1 base	Free	Store 2 base	Store 3 base	Store 4 base	Free	Free	Free

6 Main menu

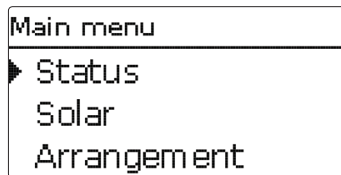

In this menu, the different menu areas can be selected.

The following menus are available:

- Status
- Solar
- Arrangement
- Heating
- HQM
- Basic settings
- SD card
- Manual mode
- User code
- In- / Outputs

- ➔ Select the menu area by pressing buttons **1** and **3**
- ➔ Press button **5** in order to enter the selected menu area



Note:

If no button is pressed for 1 min, the display illumination goes out. After 3 more minutes, the controller switches to the Status menu.

- ➔ In order to get from the Status menu into the Main menu, press button **7**!

7 Status

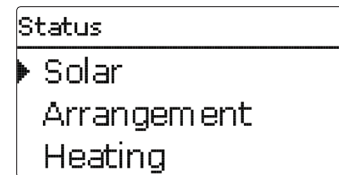

In the **Status** menu of the controller, the status messages for every menu area can be found.

7.1 Solar

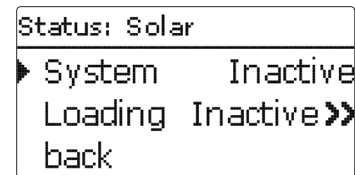

In the **Status/Solar** menu, the status of the solar system, the solar loading and the selected optional functions are indicated.

7.2 Arrangement

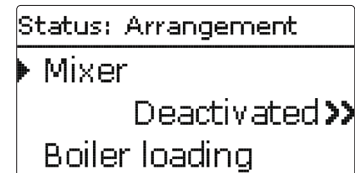

In the **Status/Arrangement** menu, the status of the selected optional functions is indicated.

7.3 Heating

```
Status: Heating
└─ Demand 1
    Inactive >>
back
```

In the **Status/Heating** menu, the status of the demands and heating circuits activated as well as of the selected optional functions is indicated.

7.4 Messages

```
Status: Messages
└─ !ΔT too high!
    Code: 0011
    collector 50 K >
```

In the **Status / Messages** menu, error and warning messages are indicated.

During normal operation, the message Everything OK is indicated.

When a monitoring function from the function control is activated and detects a fault condition, a corresponding message is indicated (see table).

A message consists of the name of the monitoring function, a 4-digit error code and a short text description of the fault condition.

In order to acknowledge the message, proceed as follows:

- ➔ Select the code line of the desired message by pressing buttons **2** and **4**.
- ➔ Acknowledge the message by pressing button **5**.
- ➔ Confirm the safety enquiry by with **Yes**.

When the expert user code has been entered, the menu item **Restarts** will appear below the messages. The number indicates how many restarts the controller went through since commissioning. This value cannot be reset.

Messages

Error code	Indication	Monitoring function	Cause
0001	!Sensor fault!	Sensor line break	Sensor line broken
0002	!Sensor fault!	Sensor short circuit	Sensor line short-circuited
0011	!ΔT too high!	ΔT too high	Collector 50 K > than store to be loaded
0021	!Night circulation!	Night circulation	Betw. 11 p.m. and 5 a.m. col. temp > 40 °C
0031	!FL/RE interchanged!	FL/RE interchanged	Col. temp. does not rise after switching on
0041	!Flow r. monit.!	Flow rate monitoring	No flow rate at sensor -
0051	!Overpressure!	Overpressure monitoring	Max. system pressure exceeded
0052	!Low pressure!	Low pressure monitoring	System pressure below minimum
0061	!Data memory defective	Storing and changing adjustments not possible	
0071	!RTC!	Time-controlled functions (e. g. night correction) not possible	
0081	!Store max. temp.!	Maximum store temperature	St. max has been exceeded
	Restarts	Restart counter (non-adjustable)	Number of restarts since commissioning



Note:

The function control „flow and return interchanged“ according to the VDI directive 2169 can only correctly detect and indicate the error „0031 !FL/RE INTERCHANGED!“ if the collector sensor measures the temperature directly in the fluid at the collector outlet. If the collector sensor is not correctly placed, a false message may occur.

- ➔ Place the collector sensor directly in the fluid at the collector outlet or deactivate the “flow and return interchanged” function control.

7.5 Meas./ Balance values

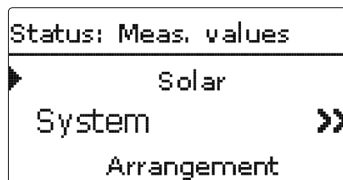

In the **Status/Meas./Balance** values menu, all current measurement values as well as a range of balance values are displayed. Some of the menu items can be selected in order to enter a sub-menu.

Additionally, all optional functions selected, the operating hours counter as well as activated heat quantity measurements are displayed.

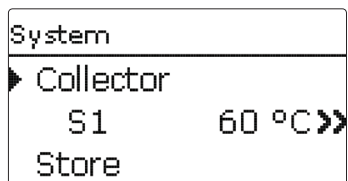

If, for example, **Solar/System** is selected, a sub-menu with the sensors and relays allocated to the solar system opens. In the sub-menu, the current temperatures and the current pump speed are displayed.

When a line with a measurement value is selected, another sub-menu will open.

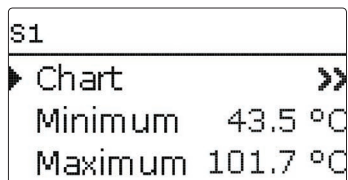

If, for example, **S1** is selected, a sub-menu indicating the minimum and maximum values will open.

When the item **Chart** is selected, a progression chart appears.

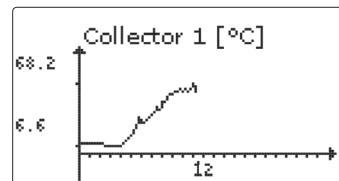

The progression chart shows the development of the temperature at the corresponding sensor over the last 24 hours. Press buttons **2** and **4** to switch back and forth between a chart of the current day and one of the day before.

7.6 Service

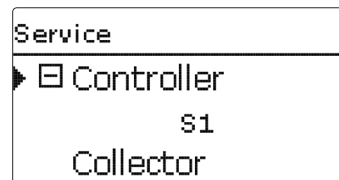

In the **Status/Service** menu, each sensor and relay is indicated with the component or function it has been allocated to. For free sensors and relays, **Free** is indicated.

8 Solar

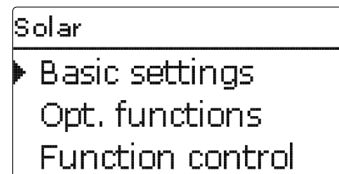

In this menu, all adjustments for the solar part of the arrangement can be made. The **Solar** menu consists of the following sub-menus:

- Basic setting
- Optional functions
- Expert

8.1 Basic solar settings

In this menu, all basic settings for the solar part of the arrangement can be adjusted. In this menu, the hydraulic system, which is the basis for the arrangement, can be adjusted. The setting is divided into systems and variants.

Both system and variant have usually been adjusted during commissioning. If the setting is changed later on, all adjustments for the solar part of the arrangement are set back to their factory settings.

If the change causes the solar system to require a relay that has been allocated to an arrangement function before, all adjustments made in the non-solar function will be set back to their factory settings as well.

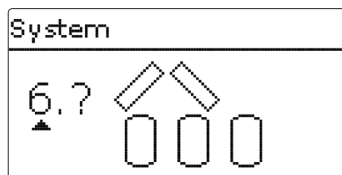

First of all, the basic solar system can be selected according to the number of stores and collector fields in use. The corresponding numbers are indicated on the display.

The exemplary figure shows system 6 with its 3 stores and 2 collector fields (east- / west collectors).

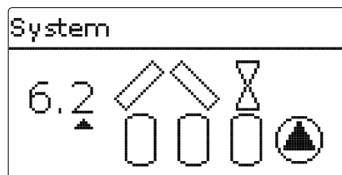

When the basic system has been selected and confirmed, the hydraulic variant can be selected. The variant is visualised on the display by means of pump and valve symbols. The exemplary figure shows variant 2 of system 6 with a 2-port valve and a pump.

For an overview of the basic systems and their variants see page 18. The controller supports up to 2 collector fields and up to 4 solar stores (with 2 collector fields only up to 3 solar stores).

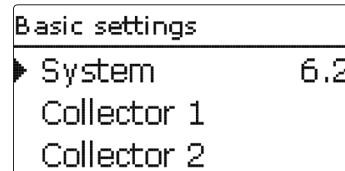

The following items in the Solar / Basic settings menu will adjust to the system selected.

Collector (1/2)

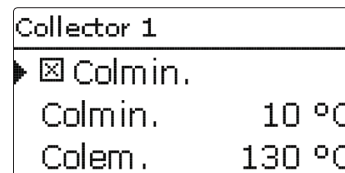

Solar / Basic settings / Collector (1/2)

Adjustment channel	Description	Adjustment range / selection	Factory setting
Colmin.	Minimum collector limitation	Yes, No	Yes
Colmin.	Minimum collector temperature	10... 90 °C	10 °C
Colem.	Collector emergency shutdown	Yes, No	Yes
Colem.	Collector emergency temperature	80... 200 °C	130 °C

In systems with 2 collector fields, 2 separate menu items (**Collector 1** and **Collector 2**) are displayed instead of **Collector**.

For each collector field, a collector minimum limitation and a collector emergency shutdown temperature can be adjusted.

Store (1 / 2 / 3 / 4)

Store 1	
▶ ΔTon	6.0 K
ΔToff	4.0 K
ΔTset	10.0 K

Solar / Basic settings / Store (1/2/3/4)

Adjustment channel	Description	Adjustment range / selection	Factory setting
ΔTon	Switch-on temperature difference	1.0 ... 20.0 K	6.0 K
ΔToff	Switch-off temperature difference	0.5 ... 19.5 K	4.0 K
ΔTset	Set temperature difference	1.5 ... 30.0 K	10.0 K
Sstet	Store set temperature	4 ... 95 °C	45 °C
Strmax	Maximum store temperature	4 ... 95 °C	60 °C
Priority	Priority	1	1 ... 4 (system-dependent)
HysSt	Hysteresis maximum store temperature	0.1 ... 10.0 K	2.0 K
Rise	Rise	1.0 ... 20.0 K	2.0 K
tmin	Minimum runtime	0 ... 300	180
Min. speed	Minimum speed	(20) 30 ... 100 %	30 %
Deactivated	Blocked for solar loading	Yes, No	No

In systems with 2 or more stores, the corresponding number of separate menu items (**Store 1 to Store 4**) is displayed instead of **Store**.

For each store, an individual ΔT control, a set and a maximum temperature, the priority, a hysteresis, a rise value, a minimum runtime and a minimum pump speed can be adjusted.

In multi-store-systems with differing Store set / Maximum store temperatures, all stores are loaded up to their Store set temperatures first (according to their priority and the store sequence control). Only when all stores have exceeded Sstet will they be loaded up to their Maximum store temperatures, again according to their priority and the store sequence control.

Loading logic

Load. logic	
▶ Load. break	2 min
Circ.	15 min
<input type="checkbox"/> Break speed	

Solar / Basic settings / Loading logic

Adjustment channel	Description	Adjustment range / selection	Factory setting
Load. break	Loading break time	1 ... 5	2
Circ.	Circulation time	1 ... 60	15
Pause speed	Pause speed	Yes, No	No
Speed	Pause speed	(20) 30 ... 100 %	30 %
Pump del.	Pump delay	Yes, No	No
Delay	Delay time	5 ... 600 s	15 s

In systems with 2 or more stores, loading logic adjustments can be made in this menu.

In systems 1 and 2, only the menu item **Pump delay** will be available.

Store sequence control:

If the priority store cannot be loaded, the subordinate store next in priority is checked. If useful heat can be added, it will be loaded for the circulation time (Circ. – factory setting 15 min).

After this, the loading process stops and the controller monitors the increase in collector temperature during the loading break time Load. break. If it increases by 2 K, the break time timer starts again to allow the collector to gain more heat. If the collector temperature does not increase sufficiently, the subordinate store will be loaded again for the Circ. time as before.

As soon as the switch-on condition of the priority store is fulfilled, it will be loaded. If the switch-on condition of the priority store is not fulfilled, loading of the second store will be continued. If the priority store reaches its maximum temperature, store sequence control will not be carried out.

If store sequence control is active and the system switches to load the priority store, the parameter Load. break also acts as a stabilisation time, during which the switch-off condition is ignored while the system operation is stabilising.

8.2 Solar optional functions

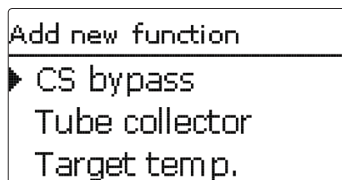

In this menu, additional functions can be selected and adjusted for the solar part of the arrangement.

By selecting **Add new function...**, different pre-programmed functions can be selected. The optional functions are available as long as free relays are available.

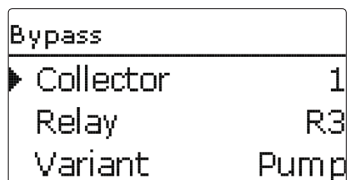

When a function is selected, a sub-menu opens in which all adjustments required can be made.

With this menu item, a relay and, if necessary, certain system components can be allocated to the function.



The menu item **Relay** is available in all optional functions. Therefore, it will not be explained in the individual function descriptions.

With this menu item, a relay can be allocated to the function. All free relays are available for selection.

In the sub-menu **Controller**, all free relays of the controller are displayed. If external modules are connected and registered, their relays will be displayed in corresponding sub-menus.

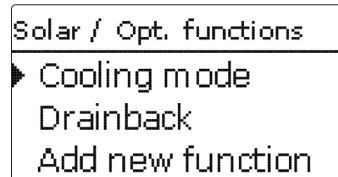

When a function has been selected and adjusted, it will appear in the **Opt. functions** menu above the menu item **Add new function...**

This allows an easy overview of functions already activated.

An overview about which sensor has been allocated to which component and which relay has been allocated to which function is given in the **Status/Service** menu.

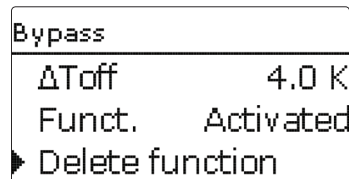

At the end of each optional function sub-menu, the menu items **Function** and **Delete function** are available.

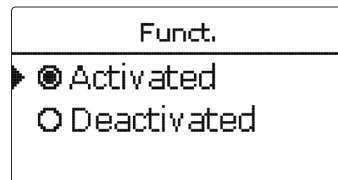

With the menu item **Function**, an optional function already selected can be temporarily deactivated or re-activated respectively. All adjustments remain stored, the allocated relays remain occupied and cannot be allocated to another function.

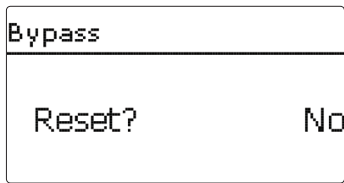

If the menu item **Delete function** is confirmed by pressing button 5, a safety enquiry appears. The setting can be changed between **Yes** and **No** by pressing buttons 2 and 4. If **Yes** has been selected and confirmed by pressing button 5, the function is deleted and available under **Add new function...** again. The corresponding relays are available again.

Bypass

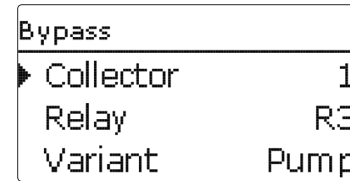

The **Bypass** function can be used for avoiding an energy loss from the store directly after loading has started. The still cold heat transfer medium in the pipework is diverted through a bypass past the store. Once the pipe is warm enough, the store can be loaded. The switch-on conditions can be adjusted individually.

Solar / Opt. functions / Add new function.../ Bypass

Adjustment channel	Description	Adjustment range / selection	Factory setting
Collector	Collector field	system dependent	system dependent
Relay	Bypass relay	system dependent	system dependent
Variant	Variant (pump or valve logic)	pump, valve	pump
Inverted	Valve logic inversion	Yes, No	No
Sensor	Bypass sensor	system dependent	system dependent
Δ Ton	Switch-on temperature difference	1.0 ... 20.0 K	6.0 K
Δ Toff	Switch-off temperature difference	0.5 ... 19.5 K	4.0 K
Funct.	Activation / Deactivation	Activated, Deactivated	Activated

Variant pump:

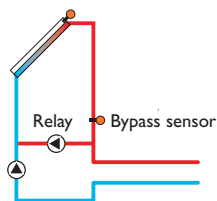

Variant valve:

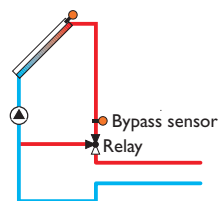

Variant valve (inverted):

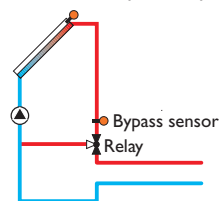

Exemplary schematics for the bypass variants

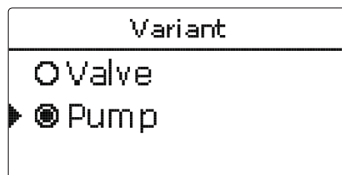

Depending on whether the bypass is energised by a valve or by a second pump, a corresponding adjustment can be made in the menu item **Variant**. Depending on the variant, different control logics are applied:

Pump:

In this version, a bypass pump is placed in front of the collector pump.

The bypass pump is first activated when store loading is possible. If the switch-on condition is fulfilled, the bypass pump is switched off and the collector circuit pump is activated.

Valve:

A bypass valve is placed into the solar circuit.

The solar heat exchanger is first bypassed when store loading is possible. If the above-mentioned switch-on condition is fulfilled, the bypass relay switches the valve and the solar circuit becomes active.

When the valve variant is selected, the option **Inverted** is additionally available. When the Inverted option is activated and the bypass circuit becomes activated, the relay switches on. When solar loading starts, the relay switches off again (see figure).



Note:

In multi-store systems with pump logic, the variant valve is not available.

CS-Bypass

CS bypass	
▶ Collector	1
Irrad.	200 W/m ²
Delay	120 s

Solar / Opt. functions / Add new function.../ CS bypass

Adjustment channel	Description	Adjustment range / selection	Factory setting
Collector	Collector field	system dependent	system dependent
Irrad.	Switch-on irradiation	100 ... 500 W/m ²	200 W/m ²
Delay	Delay time	10 ... 300 s	120 s
Stmax off	Stmax switch-on suppression	Yes, No	Yes
Func.	Activation / Deactivation	Activated, Deactivated	Deactivated

The **CS bypass** function is a different possibility to activate the collector circuit. To enable the use of the CS bypass function, a CS10 irradiation sensor has to be connected.

When the CS bypass function is activated, the irradiation value is the switch-on condition for the collector circuit.

The relay remains switched on if the irradiation value is exceeded for the Delay time. If solar loading starts or the irradiation remains below the adjusted value for the adjusted delay time, the relay is switched off.

When the option **Stmax off** is activated, collector circuit activation is suppressed as long as all store temperatures are above their respective maximum temperatures.

Tube collector function

Tube collector	
▶ Start	08:00
Stop	19:00
Run	30 s

Solar / Opt. functions / Add new function / Tube collector

Adjustment channel	Description	Adjustment range / selection	Factory setting
Start	Start time frame	00:00 ... 23:00	08:00
Stop	Stop time frame	00:30 ... 23:30	19:00
Run	Pump runtime	5 ... 600 s	30 s
Pause	Pause	1 ... 60 min	30 min
Delay	Pump delay	5 ... 600 s	30 s
Collector	Collector field	system dependent	system dependent
Funct.	Activation / Deactivation	Activated, Deactivated	Deactivated

The **Tube collector** function helps overcome the non-ideal sensor position with some tube collectors.

This function operates within an adjusted time frame. It activates the collector circuit pump for an adjustable runtime between adjustable pauses in order to compensate for the delayed temperature measurement.

If the runtime is set to more than 10 seconds, the pump will be run at 100% for the first 10 s of the runtime. For the remaining runtime, the pump will be run at the adjusted minimum speed.

If the collector sensor is defective or the collector is blocked, this function is suppressed or switched off.

2-collector systems

In 2-collector systems, the tube collector function is available for each individual collector field.

If one of the collector fields is being loaded, the heat transfer fluid flows through the inactive field and only the corresponding relay is energised.

Multi-store systems

If the tube collector function is activated, the speed of the solar pump will decrease to the minimum speed during the loading break time. The solar loading of the subordinate store will continue.

In 2-collector systems, during the loading break time, the collector field which has been active before the loading break time remains active during the loading break time, unless the tube collector function of the inactive field becomes active.

Target temperature

Target temp.	
▶ Targ. temp.	65 °C
Sensor	S3
Rise	2.0 K

Solar / Opt. functions / Add new function.../Target temperature

Adjustment channel	Description	Adjustment range / selection	Factory setting
Target temp.	Target temperature	20 ... 110 °C	65 °C
Sensor	Reference sensor	system dependent	system dependent
Rise	Rise	1.0 ... 20.0 K	2.0 K
Funct.	Activation / Deactivation	Activated, Deactivated	Deactivated

When the **Target temperature** function is activated, the pump speed control logic changes. The controller will remain at the minimum pump speed until the temperature at the allocated sensor exceeds the adjusted target temperature. Only then will the standard pump speed control start to operate. If the temperature at the allocated sensor changes by the adjusted **Rise** value, the pump speed will be adjusted correspondingly.

If the **External heat exchanger** function (see page 40) has been activated, too, the target temperature control will pause while the external heat exchanger is being loaded. While the external heat exchanger is loaded, its own pump speed control will come into effect.

Frost protection (collector)

Antifreeze	
▶ Frost on	4 °C
Frost off	6 °C
Collector	1

Solar / Opt. functions / Add new function / Antifreeze

Adjustment channel	Description	Adjustment range / selection	Factory setting
Frost on	Antifreeze switch-on temperature	-40 ... +15 °C	+4 °C
Frost off	Antifreeze switch-off temperature	-39 ... +16 °C	+6 °C
Collector	Collector field	system dependent	system dependent
Store (1...4)	Store succession order	system dependent	system dependent
Funct.	Activation / Deactivation	Activated, Deactivated	Deactivated

The **Antifreeze** function activates the loading circuit between the collector and the 1st store when the temperature falls below 4 °C in order to protect the heat transfer fluid in the loading circuit against freezing or coagulation.

When the collector temperature exceeds 6 °C, this function is switched off.

Heat will be extracted from the stores according to the adjusted order. When all stores have reached their minimum temperature of 5 °C, the function becomes inactive.

If the function is activated, the pump is run at its maximum relative speed.

In systems with east- / west collectors 2 separate menus will be displayed.



Note:

Since this function uses the limited heat quantity of the store, the antifreeze function should be used in regions with few days of temperatures around the freezing point.

Afterheating suppression

AH suppress.	
▶ Relay	R3
Store	1,2
<input type="checkbox"/> Tset	

Solar / Opt. functions / Add new function.../ AH suppression

Adjustment channel	Description	Adjustment range / selection	Factory setting
Relay	Reference relay	system dependent	system dependent
Store	Store sensor selection	system dependent	system dependent
Tset	Set temperature	Yes, No	No
Funct.	Activation / Deactivation	Activated, Deactivated	Deactivated

The **Afterheating suppression** blocks the conventional afterheating of a store that is currently in solar loading.

This function is activated if a previously selected **Store** is being loaded.

Solar loading means that store loading is only carried out for energy supply and not for cooling purposes etc. vorgenommen wird.

If the **Set temperature** option is activated, the afterheating will only be suppressed when the store temperature exceeds the **Set temperature**.

Parallel relay

Parallel relay	
▶ Relay	R3
Store	1
Funct.	Activated

Solar / Opt. functions / Add new function.../ Parallel relay

Adjustment channel	Description	Adjustment range / selection	Factory setting
Relay	Parallel relay	system dependent	system dependent
Store	Store sensor selection	system dependent	system dependent
Funct.	Activation / Deactivation	Activated, Deactivated	Deactivated

With this function, e. g. a valve can be controlled in parallel to a solar pump via a separate relay.

Switch-on condition for the solar parallel relay function is that one or more of the selected stores is being loaded. If at least one of the selected stores is being loaded, the parallel relay is energised.

The parallel relay function operates regardless whether the store is subjected to regular solar loading or to a loading caused by an optional function (such as the collector cooling).



Note:

If a relay is in the manual mode, the selected parallel relay will not be energised.

Cooling mode

In the **Cooling mode** menu, different cooling functions are available. They can be used for keeping the solar system operational for a longer time during strong solar irradiation.

For this purpose, the adjusted maximum store temperatures can be exceeded. The store order for this overloading can be adjusted. Additionally, each individual store can be excluded from this function.

Two different variants are available for the cooling mode: the system cooling and the collector cooling.

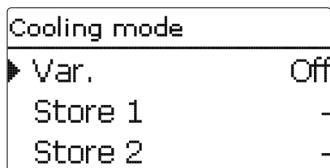

System cooling:

If the system cooling variant has been selected and the switch-on temperature difference is exceeded, store loading is continued even if the corresponding maximum temperature is exceeded, but only up to the emergency shutdown temperature. Store loading continues until all stores have reached the emergency shutdown temperature or until the switch-off temperature difference is reached.

Collector cooling:

If the collector cooling variant has been selected, store loading is continued or reactivated when the collector maximum temperature is exceeded.

Store loading continues until all stores have reached the emergency shutdown temperature or until the collector temperature falls below the collector maximum temperature by at least 5 K.

In 2-collector systems, separate adjustments can be made for each collector field. The control logic regards collector cooling operation as solar loading. The adjusted values for delay, minimum runtime, etc. remain valid. In addition to the cooling mode, store cooling is available.

Store cooling:

When the store cooling function is activated, the controller aims to cool down the store during the night in order to prepare it for solar loading on the following day.

When the store cooling function is activated, the solar pump is switched on if the maximum store temperature is exceeded and the collector temperature falls below the store temperature. The solar pump remains active until the store temperature falls below the adjusted maximum store temperature. The store order for the cooling is the same as in the overheating through system- or collector cooling.

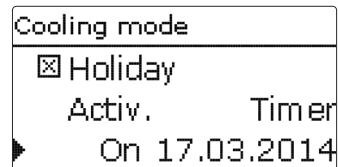

The **holiday function** works like the store cooling function but aims to cool the store further down during times without DHW consumption in order to prepare it for solar loading on the following day. This function can only be activated if the store cooling function is activated.

The holiday function can either be activated manually when a phase with no DHW consumption begins, or a time frame, during which the function is to become active, can be set in advance. If **manual** is selected, an input can be allocated to the function. When a switch is connected to the allocated input, it will act as an on/off switch for the holiday function.

Solar / Opt. functions / Add new function / Cooling mode

Adjustment channel	Description	Adjustment range / selection	Factory setting
Variant	Cooling logic variant	Col. cool, Syst. cool., Off	Off
Tcolmax.	Collector maximum temperature	70...190°C	100°C
Store (1...4)	Store succession order	system dependent	system dependent
St cooling	Store cooling	Yes, No	No
ΔTon	Switch-on temperature difference	1.0...30.0 K	20.0 K
ΔToff	Switch-off temperature difference	0.5...29.5 K	15.0 K
Holiday	Holiday function	Yes, No	No
Activation	Activation mode	Manual, Timer	Timer
On	Holiday function switch-on date	Dates up to 31.12.2099	current date
Off	Holiday function switch-off date	Dates up to 31.12.2099	On + 7 days
Input	Holiday function switch input	system dependent	system dependent
Strmax (1...4)	Maximum store temperature holiday function	4...95°C	40°C

Solar external heat exchanger

Ext. HX	
▶ Relay	R3
Min speed	30%
Store	1,2

Solar / Opt. functions / Add new function.../ Ext. HX

Adjustment channel	Description	Adjustment range/ selection	Factory setting
Relay	Relay selection	system dependent	system dependent
Min. speed	Minimum speed	(20) 30 ... 100 %	30 %
Store	Store sensor selection	system dependent	1
Sen. Ext. HX	Reference sensor ext. HX	system dependent	system dependent
Target temperature	Target temperature option	Yes, No	No
Sensor	Target temperature reference sensor	system dependent	system dependent
Target temp.	Target temperature	15 ... 95 °C	60 °C
ΔTon	Switch-on temperature difference	1.0 ... 20.0 K	10.0 K
ΔToff	Switch-off temperature difference	0.5 ... 19.5 K	5.0 K
Overrun	Overrun time	1 ... 15 min	2 min

This function is used for linking loading circuits that are separated by an external heat exchanger.

The allocated relay is energised if one of the selected stores is being loaded and there is a temperature difference between the sensor of the corresponding store and the solar flow.

Any number of the solar stores can be selected.

The relay is switched off if this temperature difference falls below the adjusted switch-off difference.

In contrast to the bypass function, a differential control between **Sen. Ext. HX** and the store temperature can be carried out by means of the heat exchanger relay.

The reference sensor can be arbitrarily allocated.

In systems in which stores are equipped with their own loading pumps, the relay “external heat exchanger“ controls the primary circuit pump.

The heat exchanger is protected by an antifreeze function. If the temperature at the external HX sensor **Sen. Ext. HX** falls below 10 °C, the secondary pump will be activated at 100 % speed. The controller will then unload the store with the lowest priority. If the temperature exceeds 12 °C, the secondary pump will be switched off. The heat exchanger antifreeze function will also become active when there is no solar loading in progress.



Note:

In order to prevent the stores from freezing while the antifreeze function of the heat exchanger is active, an afterheating has to be available for the stores.



Note:

Because of the special hydraulics in systems with 2 collectors, the target temperature function will not work properly there.

Drainback option

Drainback	
Filling time	5 min
Stab. time	2.0 min
Initialis.	60 s

Solar / Opt. functions / Add new function.../ Drainback

Adjustment channel	Description	Adjustment range / selection	Factory setting
Filling time	Filling time	1 ... 30 min	5 min
Stab. time	Stabilisation time	1.0 ... 15.0 min	2.0 min
Initialis.	Initialisation time	1 ... 100 s	60 s
Booster	Booster option	Yes, No	No
Relay	Booster pump relay selection	system dependent	system dependent
Drain impulse	Drain impulse option	Yes, No	No
Delay	Delay time	1 ... 30 min	3 min
Duration	Drain impulse loading duration	1 ... 60 s	10 s
Funct.	Activation / Deactivation	Activated, Deactivated	Deactivated

A drainback system permits the heat transfer fluid to drain back into the holding tank when solar energy is not collected. The drainback option will initiate the filling of the system when solar loading begins.



Note:

A drainback system requires additional components such as a holding tank. The drainback option should only be activated if all components required are properly installed.

The parameter **Filling time** is used for adjusting the time period for which the pump will be run at 100% speed in order to fill the system.

The parameter **Stab. time** is used for adjusting the time period during which the switch-off condition will be ignored after the filling time has ended.

The parameter **Initialis.** is used for adjusting the time period during which the switch-on condition must be permanently fulfilled for the filling procedure to start.

The **Booster** option is used for switching on a second pump when filling the solar system. The corresponding relay is switched on at 100% speed for the duration of the filling time.

A short time (Delay time) after the system has been emptied, the **Drain impulse** option will switch on the solar pump for an adjustable **Duration**. Thus, a hydrostatic head will form in the flow pipe. When it falls back into the holding tank, water pockets remaining in the collector will be sucked down into the holding tank.

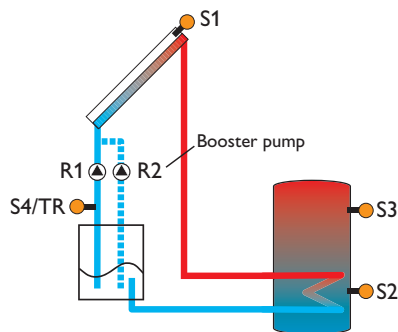

Exemplary drainback system layout (R2 = booster pump)

Twin pump

Twin pump	
Relay	R3
▶ Ref. relay	R5
Runtime	6 h

Solar / Opt. functions / Add new function.../Twin pump

Adjustment channel	Description	Adjustment range / selection	Factory setting
Relay	Relay selection	system dependent	system dependent
Reference relay	Reference relay selection	system dependent	system dependent
Runtime	Pump runtime	1 ... 48 h	6 h
Flow rate mon.	Flow rate monitoring option	Yes, No	No
Flow rate sen.	Flow rate sensor selection	Imp1, Flowrotor	Imp1
Delay	Delay time	1 ... 10 min	5 min
Funct.	Activation / Deactivation	Activated, Deactivated	Deactivated

The **Twin pump** function controls the equal distribution of pump runtime in systems with 2 equally usable pumps.

If the allocated relay has exceeded its adjusted runtime and the next switch-on process is imminent, the reference relay is switched on instead. All characteristics are adopted.

If the reference relay has in turn exceeded its runtime as well, the first relay is switched on again in the next switch-on process.

Additionally, the Flow rate monitoring option can be activated in order to activate the twin pump in the case of a flow rate error. When the flow rate monitoring option is activated, two additional adjustment channels appear for allocating a sensor and adjusting a delay time.

If the flow rate monitoring option is activated, an error message will appear when no flow rate is detected at the allocated sensor after the **Delay time** has passed. The active relay is considered as defective and will be blocked until the error message has been acknowledged. The second relay will be activated instead.

The twin pump function will pause until the error message has been acknowledged. When the error message is acknowledged, the controller runs a test during which it will energise the relay and again monitor the flow rate.

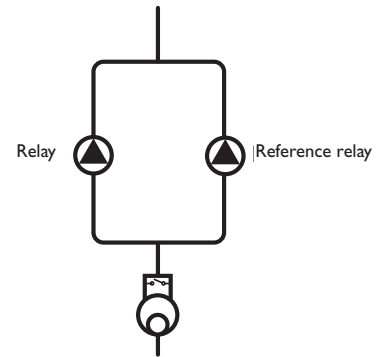

Exemplary figure of twin pumps in the solar flow with upstream flowmeter

Heat dump

Heat dump	
▶ Relay	R3
Variant	Valve
Tcol.	110 °C

Solar / Opt. functions / Add new function / Heat dump

Adjustment channel	Description	Adjustment range / selection	Factory setting
Relay	Relay selection	system dependent	system dependent
Variant	Variant (pump or valve logic)	Valve, Pump	Valve
Tcol.	Switch-on collector temperature	40 ... 190 °C	110 °C
Funct.	Activation / Deactivation	Activated, Deactivated	Activated



Note:

The switch-on collector temperature must be adjusted at least by 10 K lower than the emergency switch-off temperature.

The **Heat dump** function can be used for directing excess heat generated by strong solar irradiation to an external heat exchanger (e. g. fan coil) in order to prevent the collectors from overheating.

Whether the heat dump is activated via an additional pump or a valve can be adjusted in the menu item **Variant**.

Variant pump:

The allocated relay is energised with 100%, if the collector temperature reaches the adjusted switch-on temperature.

If the collector temperature falls by 5 K below the adjusted collector overtemperature, the relay will be switched off. In the variant pump, the heat dump function works independently from solar loading.

Variant valve:

The allocated relay will be energised in parallel to the solar pump, if the collector temperature reaches the adjusted collector overtemperature. If the collector temperature falls by 5 K below the adjusted collector overtemperature, the relay will be switched off.

If one of the store temperatures exceeds its respective maximum temperature by more than 5 K while the heat dump function is active, the function is deactivated and an error message appears. If the temperature falls below this value by the **hysteresis maximum store temperature (HysSt** in the Solar / Basic settings / Store menu), the heat dump function is released again.

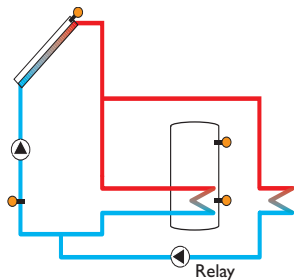

Variant pump

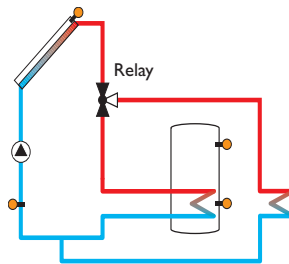

Variant valve

Flow rate monitoring

Flow rate mon.	
Sensor	FlowRotor
▶ Ref. relay	R2
Store	1

Solar / Opt. functions / Add new function.../ Flow rate mon.

Adjustment channel	Description	Adjustment range / selection	Factory setting
Sensor	Flow rate sensor selection	Imp1, Flowrotor	-
Reference relay	Reference relay selection	system dependent	-
Store	Store sensor selection	system dependent	-
Time	Delay time	1 ... 300 s	30 s
Shutdown	Shutdown option	Yes, No	No
Funct.	Activation / Deactivation	Activated, Deactivated	Activated

The **Flow rate monitoring** function can be used for detecting malfunctions that impede the flow rate and for switching off the corresponding store. This will prevent system damage, e. g. through a dry run of the pump.

In order to use the flow rate monitoring function, a **Reference relay** and a **Store** have to be selected.

If the allocated relay is energised, the flow rate will be monitored at the allocated **sensor**. An error message will appear when no flow rate is detected at the allocated sensor after the **delay time** has passed.

If the **shutdown** option has been activated for the flow rate monitoring function, the store being loaded will be blocked for any further loading until the error message has been acknowledged. The next store free for loading will be loaded instead, if possible. When the error message has been acknowledged, the monitoring function will be active again.

Pressure monitoring

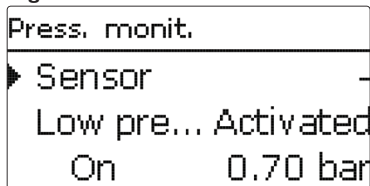

Solar / Opt. functions / Add new function.../ Pressure monitoring

adjustment channel	Description	Adjustment range / selection	Factory setting
Press. monit.	Pressure monitoring option	Yes, No	No
Overpressure	Overpressure monitoring option	Activated, Deactivated	Activated
On	Switch-on threshold	0.30 ... 10.00 bar	5.50 bar
Off	Switch-off threshold	0.20 ... 9.90 bar	5.00 bar
Shutdown	Shutdown option	Yes, No	No
Low pressure	Low pressure monitoring option	Activated, Deactivated	Activated
On	Switch-on threshold	0.00 ... 9.70 bar	0.70 bar
Off	Switch-off threshold	0.10 ... 9.80 bar	1.00 bar
Shutdown	Shutdown option	Yes, No	No
Funct.	Activation / Deactivation	Activated, Deactivated	Deactivated

The **Pressure monitoring** function can be used for detecting overpressure or low pressure conditions inside the system, and if necessary to shut down the affected system components in order to avoid system damage. So sollen Anlagenschäden vermieden werden.



Note:

The pressure monitoring function will only be available when an RPS type Grundfos Direct Sensor™ or an electronic pressure gauge is connected.

Overpressure

If the system pressure exceeds the adjustable switch-on value **On**, an error message will appear.

If the **shutdown** option has been activated for the overpressure monitoring function, the solar system will be shut down as well in the case of a fault condition.

When the pressure reaches or falls below the adjustable switch-off value **Off**, the system is switched on again.



Note:

For the Overpressure monitoring function, On has to be adjusted at least 0.1 bar higher than Off. The adjustment ranges will automatically adapt to that.

Low pressure

If the system pressure falls below the adjustable switch-on value **On**, an error message will appear.

If the **shutdown** option has been activated for the low pressure monitoring function, the solar system will be shut down as well in the case of a fault condition.

When the pressure reaches or exceeds the adjustable switch-off value **Off**, the system is switched on again.



Note:

For the Low pressure monitoring function, Off has to be adjusted at least 0.1 bar higher than On. The adjustment ranges will automatically adapt to that.

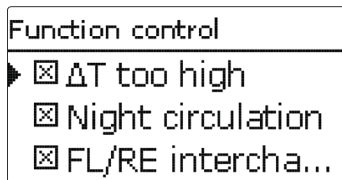

ΔT monitoring

This function can be used for monitoring the temperature difference. The message ΔT too high is shown, if solar loading has been carried out for a period of 20 minutes with a differential higher than 50K. Normal operation is not aborted or inhibited, but the system should be checked for the cause of the warning.

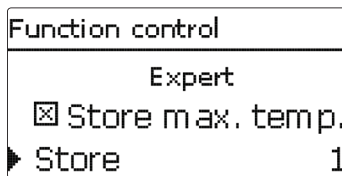

Solar / Functions control

Adjustment channel	Description	Adjustment range / selection	Factory setting
ΔT too high	Option ΔT monitoring	Yes, No	Yes
Night circulation	Night circulation monitoring option	Yes, No	Yes
FL/RE interchanged	FL/RE interchange monitoring option	Yes, No	Yes
!Store max. temp.!	Maximum store temperature monitoring option	Yes, No	No
Store	Store sensor selection	system dependent	system dependent

Possible causes are:

- pump power too weak
- blocked system components
- circulation problems in the collector
- air inside the system
- defective valve/ defective pump

Night circulation

This function can be used for detecting thermal circulation inside the solar circuit that leads to an unwanted cooling of the store. A warning message will appear when one of the following conditions has been detected for at least 1 min during the period between 11 p.m. and 5 a.m.:

- collector temperature exceeds 40 °C
- the temperature difference exceeds ΔTon

The delay time of 1 min ensures that the message is not triggered by short-term fault conditions.

Possible causes are:

- defective non-return valves
- defective valve
- wrongly adjusted time

Flow and return pipe interchanged

This function is used for detecting an interchange of the flow and return pipe or a badly placed collector sensor. For this purpose, the collector temperature is monitored for plausibility during the switch-on phases of the solar pump. The message **FL/RE interchanged** will appear, when the plausibility criteria have not been met 5 times in a row.

Only if the expert code is entered (see page 67), will the option be available.

Maximum store temperature

This function is used for detecting and indicating if the adjusted maximum store temperature has been exceeded. The controller compares the current store temperature to the adjusted maximum store temperature, thus monitoring the store loading circuits.

The maximum store temperature is considered exceeded when the temperature measured at the store sensor exceeds the adjusted maximum store temperature by at least 5 K. The monitoring becomes active again as soon as the store temperature falls below the adjusted maximum store temperature.

In the **Store** channel, the store or stores to be monitored can be selected.

A possible cause for an unwanted exceedance of the maximum store temperature is a defective valve.

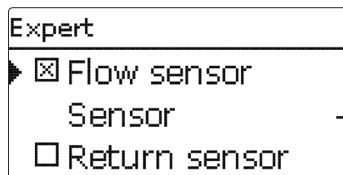

Solar / Expert

Adjustment channel	Description	Adjustment range / selection	Factory setting
Flow sensor	Flow sensor option	Yes, No	No
Sensor	Flow sensor selection	system dependent	system dependent
Return sensor	Return sensor option	Yes, No	No
Sensor	Return sensor selection	system dependent	system dependent

The **expert** menu is only available when the expert user code has been entered. In the expert menu, a flow and a return sensor can be selected and allocated. The activated sensors are then used for detecting the switch-off condition.



Note:

Because of the special hydraulics in systems with 2 collectors, this function will not work properly there.

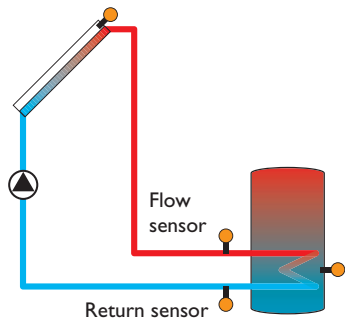

Example of flow and return sensor positions

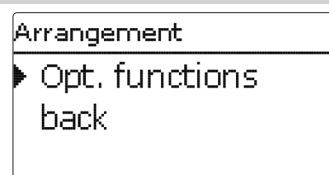

In this menu, all adjustments for the non-solar part of the arrangement can be made. A range of optional functions can be selected and adjusted.

9.1 Optional functions

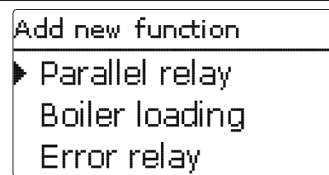

In this menu, additional functions can be selected and adjusted for the arrangement. By selecting **Add new function...**, different pre-programmed functions can be selected. The optional functions are available as long as free relays are available.

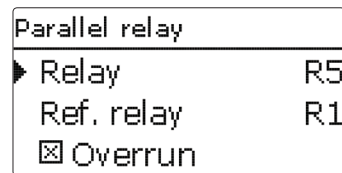

When a function is selected, a sub-menu opens in which all adjustments required can be made.

With this sub-menu, a relay and, if necessary, certain system components can be allocated to the function.

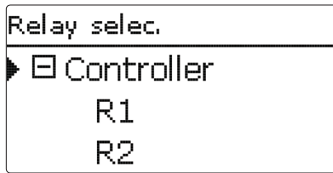

The menu item **Relay** is available in all optional functions. Therefore, it will not be explained in the individual function descriptions.

With this menu item, a relay can be allocated to the function. All free relays are available for selection.

In the sub-menu **Controller**, all free relays of the controller are displayed. If external modules are connected and registered, their relays will be displayed in corresponding sub-menus.

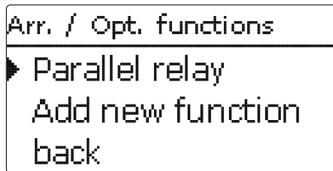

When a function has been selected and adjusted, it will appear in the **Opt. functions** menu above the menu item **Add new function...**

This allows an easy overview of functions already activated.

An overview about which sensor has been allocated to which component and which relay has been allocated to which function is given in the **Status/Service** menu.

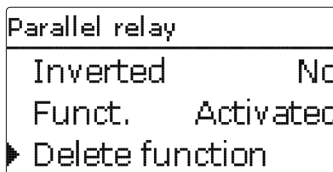

At the end of each optional function sub-menu, the menu items **Function** and **Delete function** are available.

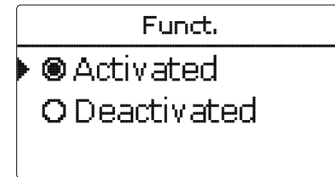

With the menu item **Function**, an optional function already selected can be temporarily deactivated or re-activated respectively. All adjustments remain stored, the allocated relays remain occupied and cannot be allocated to another function.

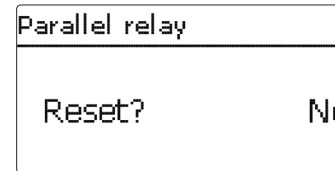

If the menu item **Delete function** is confirmed by pressing button 5, a safety enquiry appears. The setting can be changed between Yes and No by pressing buttons 2 and 4. If Yes has been selected and confirmed by pressing button 5, the function is deleted and available under **Add new function...** again. The corresponding relays are available again.

Parallel relay

Parallel relay	
▶ Relay	R5
Ref. relay	R1
<input type="checkbox"/> Overrun	

Arrangement / Opt. functions / Add new function.../ Parallel relay

Adjustment channel	Description	Adjustment range / selection	Factory setting
Relay	Relay selection	system dependent	system dependent
Reference relay	Reference relay selection	system dependent	system dependent
Overrun	Overrun option	Yes, No	No
Duration	Overrun time	1 ... 30 min	1 min
Delay	Delay option	Yes, No	No
Duration	Delay time	1 ... 30 min	1 min
Inverted	Inverted switching option	Yes, No	No
Funct.	Activation / Deactivation	Activated, Deactivated	Deactivated

The **Parallel relay** function can be used for operating an allocated parallel relay alongside a selected reference relay. With this function, e. g. a valve can be controlled in parallel to the pump via a separate relay.

If the **Overrun** option is activated, the parallel relay remains switched on for the adjusted overrun time after the reference relay has been switched off.

If the **Delay** option is activated, the parallel relay will be energised after the adjusted delay time has expired. If the reference relay is switched off again during the delay time, the parallel relay will not be switched on at all.

If the **Inverted** option is activated, the parallel relay switches on when the reference relay switches off and vice versa.



Note:

If a relay is in the manual mode, the selected parallel relay will not be energised.

Mixer

Mixer	
▶ Relay closed	R3
Relay open	R4
Sensor	S3

Arrangement / Opt. functions / Add new function.../ Mixer

Adjustment channel	Description	Adjustment range / selection	Factory setting
Relay closed	Relay selection mixer closed	system dependent	system dependent
Relay open	Relay selection mixer open	system dependent	system dependent
Sensor	Sensor selection	system dependent	system dependent
TMixer	Mixer target temperature	0 ... 130 °C	60 °C
Interval	Mixer interval	1 ... 20 s	4 s
Funct.	Activation / Deactivation	Activated, Deactivated	Deactivated

The **Mixer** function can be used for adjusting the actual flow temperature to the desired mixer target temperature **TMixer**. The mixer is opened or closed in pulses depending on this deviation. The pulses are determined by the adjustable **Interval**. The pause is determined by the difference between the actual value and the set value.

Heat exchange

Heat exchange	
▶ Relay	R3
Sen. Source	S3
Sen. Sink	S4

Arrangement / Opt. functions / Add new function.../ Heat exchange

Adjustment channel	Description	Adjustment range / selection	Factory setting
Relay	Relay selection	system dependent	system dependent
Sen. Source	Heat source sensor selection	system dependent	system dependent
Sen. Sink	Heat sink sensor selection	system dependent	system dependent
ΔT_{on}	Switch-on temperature difference	2.0 ... 30.0 K	6.0 K
ΔT_{off}	Switch-off temperature difference	1.0 ... 29.0 K	4.0 K
ΔT_{set}	Set temperature difference	1.5 ... 40.0 K	10.0 K
Min. speed	Minimum speed	(20) 30 ... 100 %	30 %
Tmax	Maximum temperature of the store to be loaded	10 ... 95 °C	60 °C
Tmin	Minimum temperature of the store to be loaded	10 ... 95 °C	10 °C
Timer	Timer	-	-
Days of the week	Day selection	All days, Monday ... Sunday, Continue	-
Timer	Time frame adjustment	00:00 ... 23:45	-
Funct.	Activation / Deactivation	Activated, Deactivated	Deactivated

The **Heat exchange** function can be used for transferring heat from a heat source to a heat sink.

The allocated relay is energised when all switch-on conditions are fulfilled:

- the temperature difference between the allocated sensors has exceeded the switch-on temperature difference
- the temperature at the heat source sensor has exceeded the minimum temperature
- the temperature at the heat sink sensor has fallen below the maximum temperature

When the **Set temperature difference** is exceeded, pump speed control starts. For every deviation of 2K, the pump speed will be adjusted by 10%.

When the **Timer** option is activated, a timer is indicated in which time frames for the function can be adjusted.



Note:

For more information about timer adjustment, see page 11.

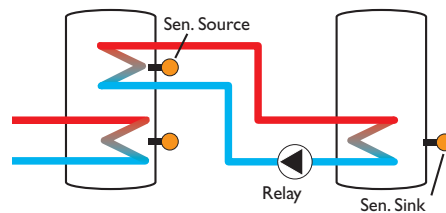

Solid fuel boiler

Solid fuel boiler	
▶ Relay	R3
Sen. Boiler	S3
Sen. Store	S4

Arrangement / Opt. functions / Add new function / Solid fuel boiler

Adjustment channel	Description	Adjustment range / selection	Factory setting
Relay	Relay selection	system dependent	system dependent
Sen. Boiler	Solid fuel boiler sensor selection	system dependent	system dependent
Sen. Store	Store sensor selection	system dependent	system dependent
ΔT_{on}	Switch-on temperature difference	1.0 ... 30.0 K	6.0 K
ΔT_{off}	Switch-off temperature difference	0.5 ... 29.5 K	4.0 K
ΔT_{set}	Set temperature difference	1.5 ... 40.0 K	10.0 K
Min. speed	Minimum speed	(20) 30 ... 100 %	30 %
Tmax St.	Maximum temperature	10 ... 95 °C	60 °C
Tmin boiler	Minimum temperature	10 ... 95 °C	60 °C
Funct.	Activation / Deactivation	Activated, Deactivated	Deactivated

The **Solid fuel boiler** function can be used for transferring heat from a solid fuel boiler to a store.

The allocated relay is energised when all switch-on conditions are fulfilled:

- the temperature difference between the allocated sensors has exceeded the switch-on temperature difference
- the temperature at the solid fuel boiler sensor has exceeded the minimum temperature
- the temperature at the store sensor has fallen below the maximum temperature

When the **Set temperature difference** is exceeded, pump speed control starts. For every deviation of 2K, the pump speed will be adjusted by 10%.

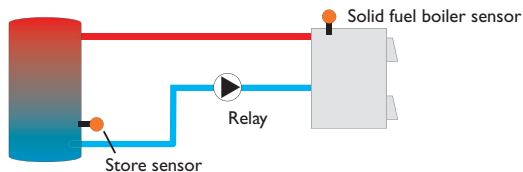

Circulation

Circulation	
▶ Relay	R3
Type	Thermal
Sensor	S3

The **Circulation function** can be used for controlling a circulation pump.

For the control logic, 5 different variants are available:

- Thermal
- Timer
- Thermal + Timer
- Demand
- Demand + Timer

If one of the variants is selected, the corresponding adjustment channels will appear.

Thermal

The temperature at the allocated sensor is monitored. The allocated relay switches on when the temperature falls below the adjusted switch-on temperature. If the temperature exceeds the switch-off temperature, the relay switches off.

Timer

The relay is switched on during the adjusted time frames, outside of them it switches off. For information on how to adjust the timer, see below.

Thermal + Timer

The relay operates when the switch-on conditions of both above mentioned variants are fulfilled.

Demand

The allocated FS08 flow switch is monitored for circuit continuity. If circuit continuity is detected at the flow switch, the relay switches on for the adjusted runtime. After the runtime has ended, the relay is switched off. During the adjusted break time, the relay remains switched off even if continuity is detected at the flow switch.

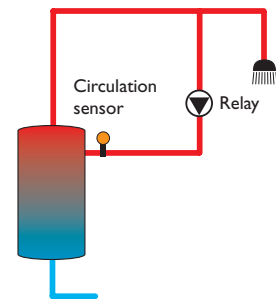

**Note:**

If the flow switch is connected to the input S1 ... S12, continuity must be detected for at least 5 s for the controller to react, 1s if the flow switch is connected to an impulse input.

Demand + Timer

The relay operates when the switch-on conditions of both above mentioned variants are fulfilled.

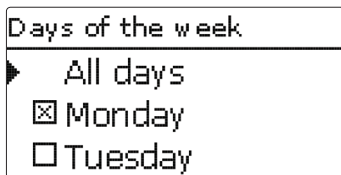
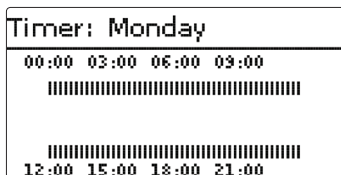

When the **Timer**, **Therm. + Timer** or **Demand + Timer** variant is activated, a timer is indicated in which time frames for the function can be adjusted.

**Note:**

For more information about timer adjustment, see page 11.

Arrangement / Opt. functions / Add new function / Circulation

Adjustment channel	Description	Adjustment range / selection	Factory setting
Relay	Relay selection	system dependent	system dependent
Type	Variant	Demand, Thermal, Timer, Therm.+Timer, Demand+Timer	Thermal
Sensor	Circulation sensor selection	system dependent	system dependent
Ton	Switch-on temperature	10 ... 59 °C	40 °C
Toff	Switch-off temperature	11 ... 60 °C	45 °C
Timer	Timer	-	-
Days of the week	Day selection	All days, Monday ... Sunday, Continue	-
Timer	Time frame adjustment	00:00 ... 23:45	-
Sensor	FS08 sensor input selection	system dependent	system dependent
Delay	Demand switch-on delay	0 ... 2 s	1 s
Runtime	Runtime	01:00 ... 15:00 min	03:00 min
Break time	Break time	10 ... 60 min	30 min
Funct.	Activation / Deactivation	Activated, Deactivated	Deactivated

Return preheating

Ret. preheat.	
Relay	R3
Sen. Return	S3
Sen. HS	S4

Arrangement / Opt. functions / Add new function / Return preheating

Adjustment channel	Description	Adjustment range / selection	Factory setting
Relay	Relay selection	system dependent	system dependent
Sen. Return	Return sensor selection	system dependent	system dependent
Sen. HS	Heat source sensor selection	system dependent	system dependent
ΔT_{on}	Switch-on temperature difference	2.0 ... 30.0 K	6.0 K
ΔT_{off}	Switch-off temperature difference	1.0 ... 29.0 K	4.0 K
Summer off	Summer switch-off option	Yes, No	No
Sensor	Outdoor sensor selection	system dependent	system dependent*
Toff	Switch-off temperature	10 ... 60 °C	20 °C*
Funct.	Activation / Deactivation	Activated, Deactivated	Deactivated

* When a heating circuit has been activated, the value adjusted in the corresponding parameter in the heating circuit menu is adopted as factory setting.

The **Return preheating** function can be used for transferring heat from a heat source to the heating circuit return.

The allocated relay is energised when both switch-on conditions are fulfilled:

- the temperature difference between the allocated sensors has exceeded the switch-on temperature difference
- the temperature at the outdoor temperature sensor has fallen below the adjusted outdoor temperature

With the summer switch-off option, the return preheating can be suppressed outside the heating period. If the heating circuit concerned is controlled by the controller, the adjustments automatically adapt to the heating circuit.

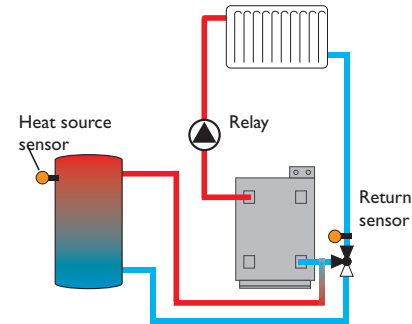

Function block

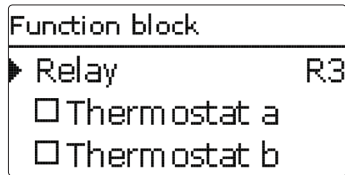

In addition to the pre-defined optional functions, function blocks consisting of thermostat functions, timer and differential functions are available. With the help of these function blocks, further components, resp. functions can be controlled.

To each function block, sensors and free relays can be allocated. Sensors already in use can be allocated again without impeding their control functions.

Within a function block the functions are interconnected (AND gate). This means that the conditions of all the activated functions have to be fulfilled (e.g. thermostat and timer) for switching the allocated relay. As soon as one condition is not fulfilled, the relay is switched off.

Thermostat function

The relay allocated to the function block is switched on, when the adjusted switch-on temperature ($Th(x)_{on}$) is reached. It is switched off when the adjusted switch-off temperature ($Th(x)_{off}$) is reached. The switching conditions of all other activated functions of the function block have to be fulfilled as well.

Allocate the reference sensor in the **Sensor** channel.

Adjust the maximum temperature limitation with $Th(x)_{off} > Th(x)_{on}$ and the minimum temperature limitation with $Th(x)_{on} > Th(x)_{off}$. The temperatures cannot be set to an identical value.

ΔT function

The relay allocated to the function block is switched on as soon as the adjusted switch-on temperature difference ($\Delta Th(x)_{on}$) is reached. It is switched off as soon as the adjusted switch-off temperature difference ($\Delta Th(x)_{off}$) is reached. The switching conditions of all other activated functions of the function block have to be fulfilled as well.

The ΔT function is equipped with a speed control function. A set temperature difference and a minimum speed can be adjusted. The non-adjustable rise value is 2K.

Reference relay

Up to 5 reference relays can be selected.

Whether the reference relays are to be switched in series (AND) or in parallel (OR) can be adjusted in the **Mode** channel.

OR mode

If at least one of the reference relays is active, the switch-on condition for the function block is considered fulfilled. The switching conditions of all other activated functions of the function block have to be fulfilled as well.

AND mode

If all reference relays are active, the switch-on condition for the function block is considered fulfilled. The switching conditions of all other activated functions of the function block have to be fulfilled as well.



Note:

For more information about timer adjustment, see page 11.



Note:

If more than one function block has been activated, relays of numerically higher function blocks may not be used as reference relays.

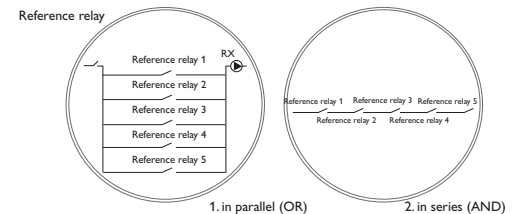
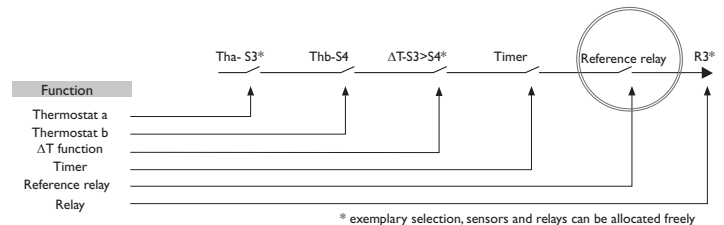

Arrangement / Opt. functions / Add new function / Function block

Adjustment channel	Description	Adjustment range / selection	Factory setting
Relay	Relay	system dependent	system dependent
Thermostat a	Thermostat a	Yes, No	No
Th-a on	Switch-on temperature Thermostat a	-40 ... +250 °C	+40 °C
Th-a off	Switch-off temperature Thermostat a	-40 ... +250 °C	+45 °C
Sensor	Sensor thermostat a	system dependent	system dependent
Thermostat b	Thermostat b	Yes, No	No
Th-b on	Switch-on temperature Thermostat b	-40 ... +250 °C	+40 °C
Th-b off	Switch-off temperature Thermostat b	-40 ... +250 °C	+45 °C
Sensor	Sensor thermostat b	system dependent	system dependent
ΔT function	Differential function	Yes, No	No
ΔTon	Switch-on temperature difference	1.0 ... 50.0K	5.0K
ΔToff	Switch-off temperature difference	0.5 ... 49.5K	3.0K
ΔTset	Set temperature difference	3 ... 100K	10K
Min. speed	Minimum speed	(20) 30 ... 100%	30%
Sen. Source	Heat source sensor	system dependent	system dependent
Sen. Sink	Heat sink sensor	system dependent	system dependent
Timer	Timer	-	No
Days of the week	Day selection	All days, Monday ... Sunday, Continue	-
Timer	Time frame adjustment	00:00 ... 23:45	-
Reference relay	Reference relay	Yes, No	No
Mode	Reference relay mode	OR, AND	OR
Relay	Reference relay 1	all relays*	-
Relay	Reference relay 2	all relays*	-
Relay	Reference relay 3	all relays*	-
Relay	Reference relay 4	all relays*	-
Relay	Reference relay 5	all relays*	-
Funct.	Activation / Deactivation	Activated, Deactivated	Activated

* Relays that have been selected as parallel relays (in the optional functions Solar/Parallel relay and Arrangement/Parallel relay) will not work as reference relays.

Irradiation switch

Irrad. switch	
▶ Relay	R3
Irrad.	200 W/m ²
Duration	2 min

Arrangement / Opt. functions / Add new function.../ Irradiation switch

Adjustment channel	Description	Adjustment range / selection	Factory setting
Relay	Relay selection	system dependent	system dependent
Irrad.	Switch-on irradiation	50 ... 1000 W/m ²	200 W/m ²
Duration	Switch-on duration	0 ... 30 min	2 min
Inverted	Inverted switching option	Yes, No	No
Funct.	Activation / Deactivation	Activated, Deactivated	Deactivated

The **Irradiation switch** function can be used for operating a relay depending on the measured irradiation value.

The allocated relay is switched on if the adjusted irradiation value remains exceeded for the adjusted duration. If the irradiation falls below the adjusted value for the adjusted duration, the relay is switched off.

If the **Inverted** option is activated, the relay operates vice versa.

10 Heating

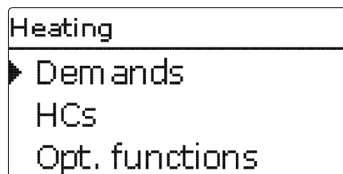

In this menu, all adjustments for the heating part of the arrangement or for the heating circuits respectively can be made.

Demands can be activated, heating circuits can be parameterised and optional functions can be selected and adjusted.

10.1 Demands

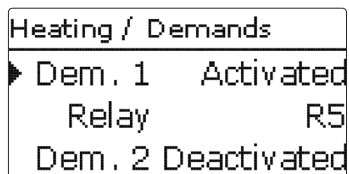

Heating / Demands

Adjustment channel	Description	Adjustment range / selection	Factory setting
Dem. 1 (2)	Demand 1	Activated, Deactivated	Deactivated
Relay	Relay selection	system dependent	system dependent

In this menu, up to 2 heating demands can be activated and adjusted.

Activated demands will be available for selection in the relay allocation channels of the corresponding optional functions of the Heating menu. This way, several optional functions can demand the same heat source.

If, for example the potential-free relay R5 is allocated to **Demand 1**, the selection **AH-Dem.1** will then become available in addition to the free relays in the adjustment channels **Demand** of the optional functions for the heating part of the arrangement (see page 63). This way, e. g. the DHW heating function can demand the same boiler for afterheating as the thermal disinfection function.

10.2 Heating circuits (with EM Extension Modules only)

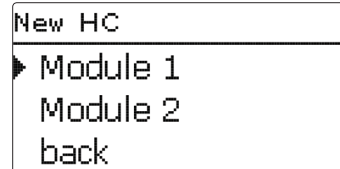

The controller is able to control 2 external, weather-compensated heating circuits by means of extension modules.

If one or more extension modules are connected, they have to be registered with the controller. Only registered modules are available in the heating circuit selection. In the menu appearing when **New heating circuit** is selected, it is possible to choose between the internal heating circuits and, if available, registered modules.

Extension modules can be registered in the In-/Outputs / Modules menu (see page 71).

If an internal or external heating circuit has been selected, a new menu opens. In this menu, all sensors and relays required for the heating circuit can be allocated, and all adjustments can be made.

The controller calculates the set flow temperature for each heating circuit by means of the outdoor temperature and the selected heating curve. If the measured flow temperature deviates from the set flow temperature, the mixer is activated in order to adjust the flow temperature correspondingly.

If the outdoor temperature falls below the point where the calculated set flow temperature would exceed the maximum flow temperature, the maximum flow temperature is treated as the set temperature for as long as the condition remains.

If the outdoor temperature sensor is defective, an error message is indicated. For the duration of this condition, the maximum flow temperature -5 K is assumed as set flow temperature.

With the timer, the day / night operation can be adjusted. During day phases, the set flow temperature is increased by the adjusted day correction value, during night phases it is decreased by the night correction value (night setback).

Summer mode

The **Mode** channel adjustment determines how the heating circuit is set to summer mode:

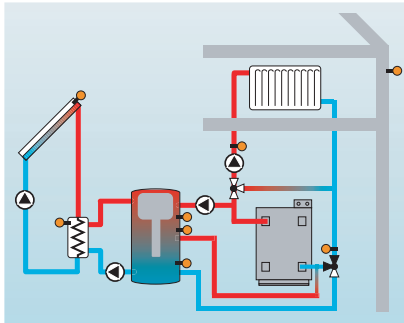

Summer off: The summer mode becomes active when the outdoor temperature exceeds the adjusted summer temperature **T_{Summer}**.

External switch: A switch is connected to a selected sensor input. If the switch is operated, the heating circuit is set to summer mode regardless of the outdoor temperature.

Both: As long as the switch is not operated, summer mode control works as described for Summer off. If the switch is operated, the heating circuit is set to summer mode regardless of the outdoor temperature.

Summer temperature

If Summer off or Both has been selected in the Mode channel, the summer temperature **T_{Summer}** can be adjusted. If the outdoor temperature exceeds the value adjusted in **T_{Summer}**, the heating circuit pump is switched off.

Heating curves

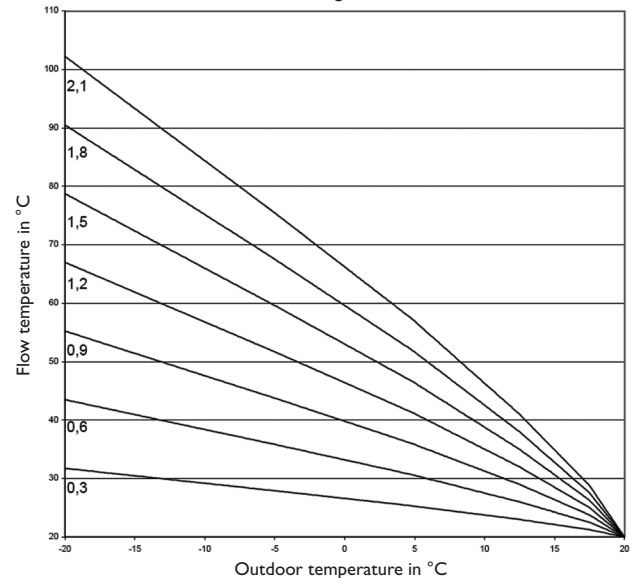

For the summer temperature, a daytime time frame can be adjusted with the channels **Daytime on** and **Daytime off**. Outside this time frame, the adjustable temperature **T_{Night}** replaces **T_{Summer}**.

With the **Room thermostat** option, up to 5 room thermostats can be integrated into the control logic.

To each room thermostat, a sensor input can be allocated. The temperature at the allocated sensor is monitored. If the measured temperature exceeds the adjusted **Room temperature** value at all activated room thermostats, the heating circuit pump is deactivated and the mixer position is retained.

Common room thermostats with potential-free outputs can be used alternatively. In this case, Switch must be selected in the Type channel. Beforehand, the corresponding input must also be set to Switch in the Inputs / Outputs menu (see controller manual). Only inputs set to Switch will be displayed in the **Sen. RTH** channel as possible inputs for a switch type room thermostat.

If the **Timer RTH** option is activated, time frames can be set for the room thermostats (for information on how to adjust the timer see below). During these time frames, the adjusted room temperature is decreased by the **Correction** value.

To each room thermostat, an additional relay can be allocated. That relay will operate when the temperature at the allocated sensor falls below the adjusted room temperature. This way, the room in question can be excluded from the heating circuit via a valve as long as the desired room temperature is reached.

In the channel **RTH**, the room thermostat can be temporarily deactivated or re-activated respectively. All adjustments remain stored.

When the **Timer** option is activated, a timer is indicated in which time frames for the function can be adjusted.



Note:

For more information about timer adjustment, see page 11.

Heating / Heating circuits / New heating circuit / Internal

Adjustment channel	Description	Adjustment range / selection	Factory setting
HC pump	Heating circuit pump	system dependent	system dependent
Mixer open	Relay selection mixer open	system dependent	system dependent
Mixer closed	Relay selection mixer closed	system dependent	system dependent
Flow sensor	Flow sensor selection	system dependent	system dependent
Sensor. Outdoor.	Outdoor sensor selection	system dependent	system dependent
Heating curve	Heating curve	0.3 ... 3.0	1,0
Day correction	Day correction	-5 ... +45 K	0 K
Tflowmax	Maximum flow temperature	10 ... 100 °C	50 °C
Mode	Operation mode	Summer off, Ext. switch, Both	Summer off
Tsummer	Summer temperature day	0 ... 40 °C	20 °C
Daytime on	Daytime on	00:00 ... 23:45	00:00
Daytime off	Daytime off	00:00 ... 23:45	00:00
Ext. switch	External switch sensor input selection	system dependent	system dependent
Remote control	Remote control option	Yes, No	No
Sen. Rem. c.	Remote control sensor input selection	system dependent	system dependent
Timer	Timer option	Yes, No	No
Mode	Timer mode	Day / Night, Day / Off	Day / Night
Night corr.	Night correction	-20 ... +30 K	-5 K
Timer	Timer	-	-
Days of the week	Day selection	All days, Monday ... Sunday, Continue	-
Timer	Time frame adjustment	00:00 ... 23:45	-
Room therm. 1 ... 5	Room thermostat option (1 ... 5)	Yes, No	No
Type	Room thermostat type selection	Sensor, Switch	Sensor
Sen. RTH	RTH sensor input selection	system dependent	system dependent
Tamb	Room ambient temperature	10 ... 30 °C	18 °C

Adjustment channel	Description	Adjustment range / selection	Factory setting
Timer	RTH timer	Yes, No, Inactive	No
Days of the week	Day selection	All days, Monday... Sunday, Continue	-
Timer	Time frame adjustment	00:00... 23:45	-
Correction	Correction	1... 20K	5K
Relay	RTH relay selection	system dependent	-
RTH	Room thermostat	Activated, Deactivated	Activated
Afterheating	Afterheating option	Yes, No	No
Mode	Afterheating mode	Therm., Boiler	Therm.
Relay	Afterheating relay selection	system dependent	-
Sensor 1	Afterheating sensor 1 selection	system dependent	-
Sensor 2	Afterheating Sensor 2 (only if Mode = Boiler)	system dependent	-
Loading pump	Loading pump option	Yes, No	No
Relay	Loading pump relay selection	system dependent	-
Overrun time	Loading pump overrun time	0... 300 s	60 s
Activ.	Activation / Deactivation	Activated, Deactivated	Deactivated
ΔT_{on}	Switch-on temperature difference	-15.0... +44.5K	+5.0K
ΔT_{off}	Switch-off temperature difference	-14.5... +45.0K	+15.0K
Function	Function activated / deactivated	Activated, Deactivated	Deactivated
Interval	Mixer interval	1... 20 s	4 s
Chimney sweeper	Chimney sweeper function	Yes, No	No
Frost protection	Antifreeze option	Yes, No	Yes
Sensor	Antifreeze option sensor	Flow, Outdoor	Flow
Antifr. temp.	Antifreeze temperature	-20... +10 °C	+4 °C
Flow set	Set flow temperature	10... 50 °C	20 °C
DHW priority	DHW priority option	Yes, No	No
Funct.	Activation / Deactivation	Activated, Deactivated	Activated

Chimney sweeper function

The chimney sweeper function can be used for enabling a quick access to measurement conditions without menu operation for the chimney sweeper.

If the chimney sweeper function is activated, the chimney sweeper mode can be accessed by pressing button  for 5 seconds.

In the chimney sweeper mode, the heating circuit mixer opens, the heating circuit pump and the afterheating contact are activated. While the chimney sweeper mode is active, the directional pad is illuminated. Additionally, **Chimney sweeper** and a countdown of 30 minutes are indicated on the display.

When the countdown has elapsed, the chimney sweeper mode is automatically deactivated. If, during the countdown, button  is again pressed for more than 10 s, the countdown starts again.

In order to abort the countdown and thus deactivate the chimney sweeper mode, briefly press button .

Antifreeze option

The antifreeze option of the heating circuit can be used for temporarily activating an inactive heating circuit during sudden temperature drops in order to protect it from frost damage.

When the antifreeze option is activated, the temperature at the allocated sensor is monitored. If the temperature falls below the adjusted **antifreeze temperature**, the heating circuit is activated for the non-adjustable runtime of 30 min. Antifreeze operation has a fixed set flow temperature which can be changed in the **Flow set** channel.

10.3 Optional functions

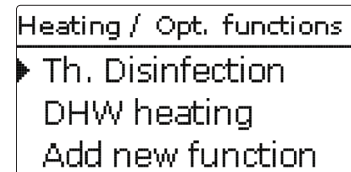

In this menu, additional functions can be selected and adjusted for the heating part of the arrangement.

By selecting **Add new function...**, different pre-programmed functions can be selected. The optional functions are available as long as free relays are available.

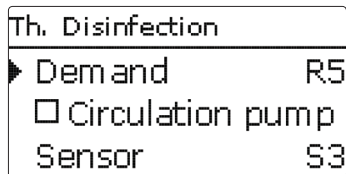

When a function is selected, a sub-menu opens in which all adjustments required can be made.

With this sub-menu, a relay and, if necessary, certain system components can be allocated to the function.

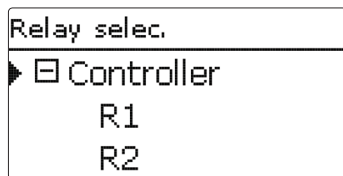

The menu item **Demand** for the relay selection is available in all optional heating functions. Therefore, it will not be explained in the individual function descriptions. In this menu, a heating demand relay can be allocated to the function. All free relays are available for selection.

In the sub-menu **Controller**, all free relays of the controller are displayed. If external modules are connected and registered, their relays will be displayed in corresponding sub-menus.

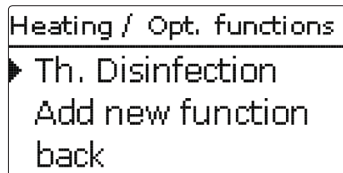

When a function has been selected and adjusted, it will appear in the **Opt. functions** menu above the menu item **Add new function....**

This allows an easy overview of functions already activated.

An overview about which sensor has been allocated to which component and which relay has been allocated to which function is given in the **Status/Service** menu.

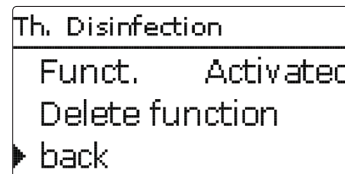

At the end of each optional function sub-menu, the menu items **Function** and **Delete function** are available.

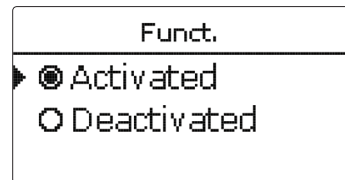

With the menu item **Function**, an optional function already selected can be temporarily deactivated or re-activated respectively. All adjustments remain stored, the allocated relays remain occupied and cannot be allocated to another function.

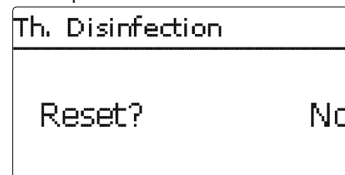

If the menu item **Delete function** is confirmed by pressing button ③, a safety enquiry appears. The setting can be changed between Yes and No by pressing buttons ② and ④. If Yes has been selected and confirmed by pressing button ③, the function is deleted and available under **Add new function...** again. The corresponding relays are available again.

Thermal disinfection

Th. Disinfection	
▶ Demand	R5
□ Circulation pump	
Sensor	S3

This function helps to contain the spread of Legionella in DHW stores by systematically activating the afterheating.

For thermal disinfection, the temperature at the allocated sensor has to be monitored. This protection is ensured when, during the monitoring period, the disinfection temperature is continuously exceeded for the entire disinfection period.

If the thermal disinfection function is activated, the monitoring period starts as soon as the temperature at the allocated sensor falls below the disinfection temperature. When the monitoring period ends, the allocated reference relay activates the afterheating. The disinfection period starts to count as soon as the temperature at the allocated sensor exceeds the disinfection temperature.

If the temperature at the allocated sensor exceeds the disinfection temperature by more than 5 K, the reference relay switches off until the temperature has fallen below a value of 2 K above the disinfection temperature.

Thermal disinfection can only be completed when the disinfection temperature is exceeded for the duration of the disinfection period without interruption.

If the disinfection conditions have been fulfilled by solar loading before the monitoring period ends, thermal disinfection is considered complete and a new monitoring period begins.

Due to the flexible control logic, the exact time of thermal disinfection is not predictable. In order to set a fixed time for the disinfection, the starting delay can be used.

Th. Disinfection	
▶ <input checked="" type="checkbox"/> Start. time	
Start. time	20:00
Hyst. off	5 K

Heating / Opt. functions / Add new function.../Th. disinfection

Adjustment channel	Description	Adjustment range / selection	Factory setting
Dem.	Demand relay selection	system dependent	system dependent
Circulating pump	Circulating pump option	Yes, No	No
Relay	Circulating pump relay selection	system dependent	system dependent
Sensor	Disinfection sensor selection	system dependent	system dependent
Interval	Monitoring period	0 ... 30, 1 ... 23 (dd:hh)	1d 0h
Temperature	Disinfection temperature	45 ... 90 °C	60 °C
Duration	Disinfection period	0.5 ... 24.0 h	1.0 h
Starting time	Starting delay option	Yes, No	No
Starting time	Starting point	00:00 ... 23:30	20:00
Funct.	Activation / Deactivation	Activated, Deactivated	Deactivated

If the starting delay option **Starting time** is activated, a starting time for the thermal disinfection with starting delay can be adjusted. The activation of the afterheating is then delayed until that starting time after the monitoring period has ended. If the monitoring period ends, for example, at 12:00 o'clock, and the starting time has been set to 18:00, the reference relay will be energised with a delay of 6 hours at 18:00 instead of 12:00 o'clock.

If, before the delay time has elapsed, the disinfection conditions are fulfilled by solar loading, thermal disinfection is considered complete and a new monitoring period begins.

DHW heating

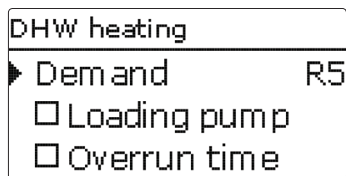

Heating / Opt. functions / Add new function.../ DHW heating

Adjustment channel	Description	Adjustment range / selection	Factory setting
Dem.	Demand relay selection	system dependent	system dependent
Loading pump	Loading pump option	Yes, No	No
Relay	Loading pump relay selection	system dependent	system dependent
Overrun time	Overrun option	Yes, No	No
Duration	Overrun time	1 ... 10 min	1 min
Mode	Operating mode	Boiler, Therm.	Therm.
Sensor 1	Sensor 1	system dependent	system dependent
Sensor 2	Sensor 2 (only if Mode = Boiler)	system dependent	system dependent
Ton	Switch-on temperature	0 ... 94 °C	40 °C
Toff	Switch-off temperature	1 ... 95 °C	45 °C
Timer	Timer option	Yes, No	No
Timer	Timer	-	-
Days of the week	Day selection	All days, Monday ... Sunday, Continue	-
Timer	Time frame adjustment	00:00 ... 23:45	-
Funct.	Activation / Deactivation	Activated, Deactivated	Deactivated

The DHW heating is used for demanding an afterheating for heating the DHW store.

If the **Loading pump** option is activated, another adjustment channel appears, in which a relay can be allocated to the loading pump. The allocated relay is switched on and off with the demand relay.

If the **Overrun time** option is activated, another adjustment channel appears, in which the overrun time can be adjusted. If the overrun time option is activated, the loading pump relay remains switched on for the adjusted Duration after the demand relay has been switched off.

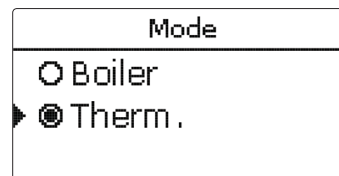

For the DHW heating, different modes are available:

Thermal mode

The allocated demand relay is switched on when the temperature at the allocated Sensor 1 falls below the adjusted switch-on temperature. If the temperature at the allocated sensor 1 exceeds the adjusted switch-off temperature, the relay is switched off.

Boiler mode

If the Boiler mode has been selected, another sensor can be allocated in the channel Sensor 2. The switch-on, or the switch-off conditions respectively, then have to be fulfilled at both sensors in order for the relay to be switched on or off.

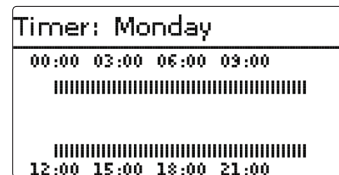

When the **Timer** option is activated, a timer is indicated in which time frames for the function can be adjusted.



Note:

For more information about timer adjustment, see page 11.

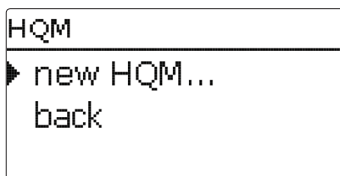

In the **HQM** menu, up to seven internal heat quantity measurements can be activated and adjusted.

By selecting the menu item **New HQM...**, a new heat quantity measurement can be activated.

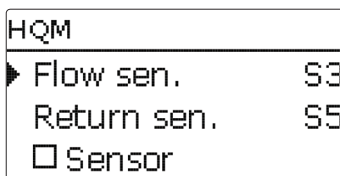

A menu opens in which all adjustments required for the heat quantity measurement can be made.

If the **Flow rate sensor** option is activated, the impulse input or, if available, a Grundfos Direct Sensor™ can be selected. Grundfos Direct Sensors™ are only available if they have been previously registered in the In-/Outputs menu. The impulse rate must be adjusted in that menu as well.

If the **Flow rate sensor** option is deactivated, the controller calculates the heat quantity by means of a fixed flow rate value. This is called heat quantity balancing. For this purpose, the flow rate must be read from the flowmeter at 100 % pump speed and adjusted in the adjustment channel **Flow rate**. In addition to that, a **Relay** must be allocated. Heat quantity balancing is in effect whenever the allocated relay is active.

In the adjustment channel **Fluid type**, the heat transfer fluid must be selected. If either Propylene glycol or Ethylene glycol is selected, the adjustment channel **Ratio** is indicated in which the antifreeze ratio of the heat transfer fluid can be adjusted.

When the **Alternative unit** option is activated, the controller will convert the heat quantity into the quantity of fossil fuels (coal, oil or gas) saved, or the CO₂ emission saved respectively. The alternative **unit** can be selected. A **conversion factor** must be adjusted for the calculation. The conversion factor depends on the arrangement in use and has to be determined individually.

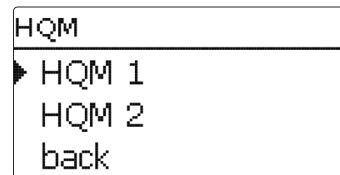

Heat quantity measurements already activated will appear in the HQM menu above the menu item **New HQM** in numerical order.

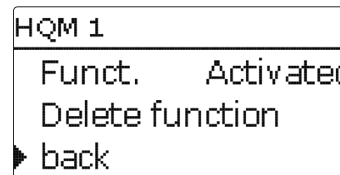

If an activated heat quantity measurement is selected, the above mentioned menu with all adjustment values will re-open.

To deactivate a heat quantity measurement, select the menu item **Delete function** at the bottom of the menu.

The heat quantity measurement deleted will disappear from the list and become available for selection in the **New HQM** menu again. The numeration of the other activated heat quantity measurements will not change.

HQM / New HQM

Adjustment channel	Description	Adjustment range / selection	Factory setting
Flow sen.	Flow sensor selection	system dependent	system dependent
Return sen.	Return sensor selection	system dependent	system dependent
Flow rate sen.	Flow rate sensor option	Yes, No	No
Flow rate sen.	Flow rate sensor selection	Imp1, Imp2, Gd1, Gd2	-
Flow r.	Flow rate (only if Flow rate sen. = No)	1.0 ... 500.0 l/min	3.0 l/min
Relay	Relay selection	system dependent	system dependent
Fluid type	Heat transfer fluid	Tyfocor LS, Propylene glycol, Ethylene glycol, Water	Water
Ratio	Glycol ratio in the heat transfer fluid (only if Fluid type = Propylene glycol or Ethylene glycol)	5 ... 100 %	40 %
Alternative unit	Alternative unit option	Yes, No	No
Unit	Alternative display unit	Coal, Gas, Oil, CO ₂	CO ₂
Factor	Conversion factor	0.0000001 ... 100.0000000	0,5000000
Funct.	Activation / Deactivation	Activated, Deactivated	Deactivated

12 Basic settings

Basic settings	
Language	English
<input checked="" type="checkbox"/> Auto DST	
Date	17.03.2014

Basic settings

Adjustment channel	Description	Adjustment range / selection	Factory setting
Language	Selection of the menu language	Deutsch, English, Français, Italiano, Español	German
Auto DST	Daylight savings time selection	Yes, No	Yes
Date	Adjustment of the current date	01.01.2001 ... 31.12.2099	01.01.2010
Time	Adjustment of the current time	00:00 ... 23:59	-
Temp. unit	Temperature unit	°C, °F	°C
Vol. unit	Volume unit	Gallons, Liter	Liter
Press. unit	Pressure unit	psi, bar	bar
Energy unit	Energy unit	Wh, BTU	Wh
Factory setting	back to factory settings	Yes, No	No

In the **Basic settings** menu, all basic parameters for the controller can be adjusted. Normally, these settings have been made during commissioning. They can be changed later on in this menu.

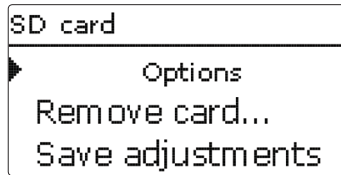

The controller is equipped with an SD card slot for SD memory cards.

With an SD card, the following functions can be carried out:

- Logging measurement and balance values. After the transfer to a computer, the values can be opened and visualised, e. g. in a spreadsheet.
- Store adjustments and parameterisations on the SD card and, if necessary, retrieve them from there.
- Running firmware updates on the controller.

Firmware updates

The current software can be downloaded from www.resol.de/firmware.

When an SD card with a firmware update is inserted, the enquiry **Update?** is indicated on the display. The setting can be changed between Yes and No by pressing buttons **2** and **4**.

→ To run the update, select **Yes** and confirm by pressing button **5**.

The update is run automatically. The indication **Please wait** and a progress bar appear on the display. When the update has been completed, the controller will automatically reboot and run a short initialisation phase.

→ To skip the update, select **No**.

The controller commences normal operation.



Note:

The controller will only recognise a firmware update file if it is stored in a folder named **SC514** on the first level of the SD card.

→ Create a folder named **SC514** on the SD card and extract the downloaded ZIP file into this folder.

Starting the logging

- Insert the SD card into the slot
 - Adjust the desired logging type and interval
- Logging will start immediately.

Stopping the logging

- Select the menu item **Remove card...**
- After **Remove card** is displayed, remove the card from the slot

When **Linear** is adjusted in the **Logging type** adjustment channel, data logging will stop if the capacity limit is reached. The message **Card full** will be displayed.

When **Cyclic** is adjusted, the oldest data logged onto the SD card will be overwritten as soon as the capacity limit is reached.



Note:

Because of the increasing size of the data packets, the remaining logging time does not decrease linearly. The data packet size can increase, e. g. with the increasing operating hours value.

Storing controller adjustments

- To store the controller adjustments on an SD card, select the menu item **Save adjustments**.

While the adjustments are being stored, first **Please wait**, then **Done!** will be indicated on the display. The controller adjustments are stored as a .SET file on the SD card.

Controller adjustments, loading of

- To load controller adjustments from an SD card, select the menu item **Load adjustments**.

The File selection window is indicated.

- Select the desired .SET file.

While the adjustments are being loaded, first **Please wait**, then **Done!** will be indicated on the display.

Formatting the SD card

➔ Select the menu item **Format card**

The content of the card will be deleted and the card will be formatted with the FAT file system.



Note:

To safely remove the SD card, always select the menu item **Remove card...** before removing the card.

SD card

Adjustment channel	Description	Adjustment range / selection	Factory setting
Remove card...	Safely remove card	-	-
Save adjustments	Save adjustments	-	-
Load adjustments	Load adjustments	-	-
Logging interval	Logging interval	00:01 ... 20:00 (mm:ss)	01:00
Logging type	Logging type	Cyclic, Linear	Linear
Format card	Format card	-	-

14 Manual mode

```
Manual mode
-----
          Controller
▶ Relay 1      Auto
  Relay 2      Auto
```

Manual mode

Adjustment channel	Description	Adjustment range / selection	Factory setting
Relay 1 ... X	Operating mode selection	Max, Auto, Min, Off	Auto
All relays...	Operating mode of all relays	Auto, Off	Off

In the Manual mode menu, the operating mode of all relays in the controller and in connected modules can be adjusted.

All relays are displayed in numerical order, first those of the controller, then those of the individual modules connected. Modules are listed in numerical order.

In the menu item **All relays...**, all relays can be switched off (Off) or set to automatic mode (Auto) at once:

Off = Relay is switched off (manual mode)

Auto = Relay is in automatic mode

```
Relay 1
-----
○ Max
▶ ● Auto
○ Min
```

The operating mode can be selected for each individual relay, too. The following options are available:

Off = Relay is switched off (manual mode)

Min = Relay is active at minimum speed (manual mode)

Max = Relay is active at 100 % (manual mode)

Auto = Relay is in automatic mode



Note:

After service and maintenance work, the relay mode must be set back to **Auto**. Otherwise normal operation will not be possible.

15 User code

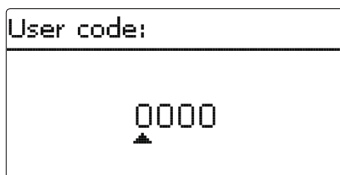

```
User code:
0000
^
```

In the **User code** menu, a user code can be entered. Each number of the 4-digit code must be individually adjusted and confirmed. After the last digit has been confirmed, the menu automatically jumps to the superior menu level.

To access the menu areas of the expert level, the expert user code must be entered:

Expert user code: 0262

For safety reasons, the user code should generally be set to the customer code before the controller is handed to the customer!

Customer user code: 0000

16 In- / Outputs

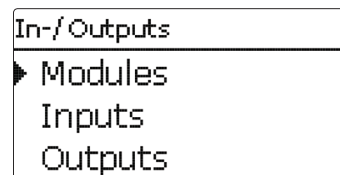

```
In-/Outputs
▶ Modules
  Inputs
  Outputs
```

In the **In- / Outputs** menu, external modules can be registered, sensor offsets can be adjusted and relay outputs can be configured.

16.1 Modules

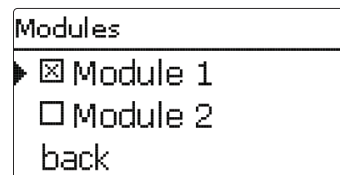

```
Modules
▶  Module 1
   Module 2
  back
```

In this menu, up to 2 external modules can be registered.

All modules connected and acknowledged by the controller are available.

→ To register a module, select the corresponding menu item by pressing button 

The checkbox indicates the selection. If a module is registered, all its sensor inputs and relay outputs will be available in the corresponding controller menus.

In- / Outputs / Modules

Adjustment channel	Description	Adjustment range / selection	Factory setting
Module 1 ... 2	Registering external modules	-	-

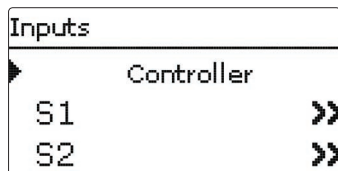

In this sub-menu, the type of the sensor connected can be adjusted for each individual input. The following types can be selected:

- Switch
- KTY
- Pt500
- RTA11-M
- Pt1000
- None

ATTENTION! System damage!



Selecting the wrong sensor type will lead to unwanted controller actions. In the worst case, system damage can occur!

→ **Make sure that the right sensor type is selected!**

If KTY, Pt500 or Pt1000 are selected, the channel **Offset** appears, in which an individual offset can be adjusted for each sensor.

→ In order to select a sensor for the offset adjustment, select the corresponding menu item by pressing button ⑤

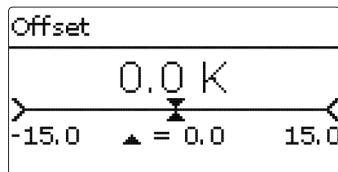

→ To adjust the sensor offset, select the desired value by pressing buttons ② or ④, then confirm by pressing button ⑤

CS sensor offset

If a CS10 irradiation sensor is to be connected, an offset has to be carried out before the connection is made.

To carry out the offset, proceed as follows:

- Adjust the **CS type** in the **Type** channel
- Select the **Offset** channel
- Confirm the reset enquiry by selecting **Yes**
- Select back to return to the Inputs menu, then connect the CS sensor



Note:

When Grundfos Direct Sensors™ are used, the sensor ground common terminal block must be connected to PE (see controller manual).

In- / Outputs / Inputs

Adjustment channel	Description	Adjustment range / selection	Factory setting
S1 ... S9	Sensor input selection	-	-
Type	Selecting the sensor type	Switch, KTY, Pt500, RTA11-M, Pt1000, None	Pt1000
Offset	Sensor offset	-15.0 ... +15.0 K	0.0 K
S10	Impulse input submenu	-	-
Type	Selecting the sensor type	Impulse, Switch, KTY, Pt500, RTA11M, Pt1000, None	Impulse
Vol./Imp.	Impulse rate	0.1 ... 100.0	1,0
CS10	CS10 input	-	-
Type	CS type	A ... K	E
Offset	Delete offset	Yes, No	No
FlowRotor		FlowRotor	-
Type	FlowRotor type	DN20, DN25, DN32, DN32 cascade, none	None
RPS	Analogue Grundfos sensor, electrical pressure gauge	-	-
Type	Choice between RPS and pressure gauge	RPS, Pressure gauge, none	None
Max.	Maximum pressure	0.0 ... 10	6,0

16.3 Outputs

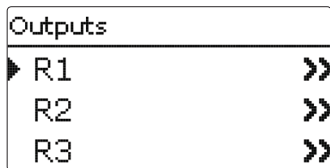

In this menu, the signal type and the minimum speed can be adjusted for each individual relay of the controller and the external modules.

➔ In order to make adjustments for a relay, select the corresponding menu item by pressing button **5**.

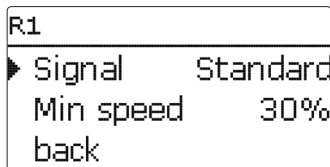

For each relay, the signal type and the minimum pump speed can be adjusted.

The signal type determines the way speed control of a connected pump is effected. The following modes are available:

Adapter = Speed control signal via a VBus®/PWM interface adapter

0-10V = Speed control via a 0-10V signal

PWM = Speed control via a PWM signal

Standard = Burst control (factory setting)

With the signal types Adapter, 0-10V and PWM, the relay itself is not involved in speed control. A separate connection for the corresponding signal will have to be made (see figure).

If **PWM** is selected, the channels **Output** and **Profile** appear. In the Output channel, one of the 4 PWM/0-10 V outputs can be selected. In the Profile channel, different characteristic curves corresponding with the pump in use can be selected (see page 74).

In order to reduce the number of switching processes for high-efficiency pumps, the controller is equipped with a relay overrun function that automatically comes into effect when the speed control signal is not issued by the relay itself. The corresponding relay will then remain switched on for an hour after the switch-off conditions are fulfilled.

In- / Outputs / Outputs

Adjustment channel	Description	Adjustment range / selection	Factory setting
R1 ... R5	Relay output selection	-	-
Signal	Signal type	Adapter, 0-10 V, PWM, Standard	Standard
Output	PWM output selection	PWM1, PWM2, PWM3, PWM4	-
Profile	Curve	Solar, Heating	Solar
Min. speed	Minimum speed	(20) 30 ... 100 %	30 %



Note:

When the minimum pump speed value adjusted in the **Outputs** menu differs from the minimum pump speed adjusted in an optional function that uses the same output, only the higher value will be come into effect.



Note:

If PWM, Adapter or 0-10V is selected for an output, the adjustment range for the corresponding minimum speed will extend to 20 ... 100 %. If a Laing pump is used, the minimum speed must be set to at least 25 % according to information from the manufacturer.

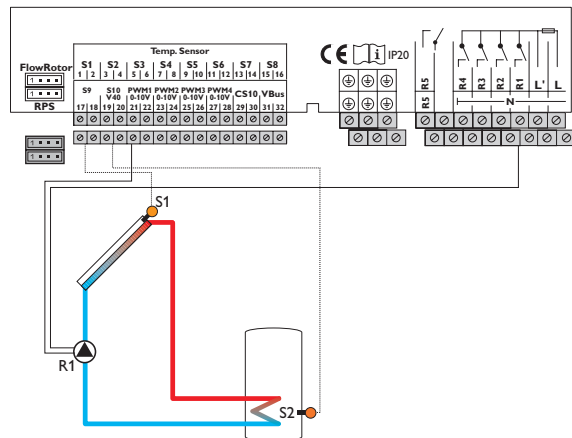

Example of the electrical connection of a high-efficiency pump

16.4 PWM profiles

Signal characteristic: PWM; Profile: Solar

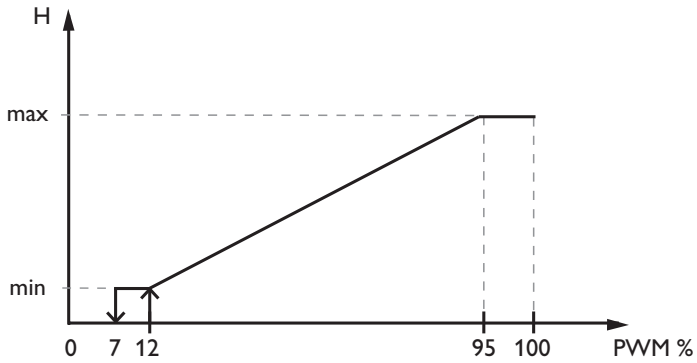

Signal characteristic: PWM; Profile: Heating

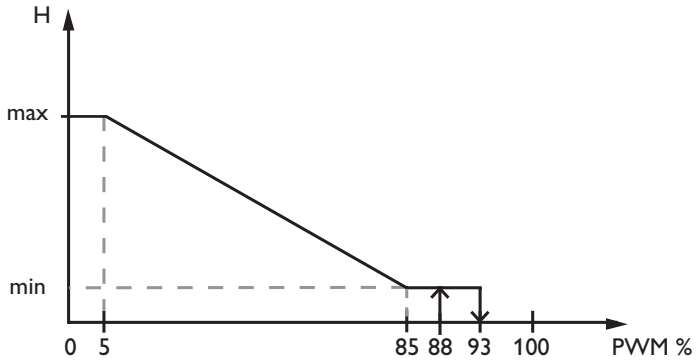

17 Troubleshooting

If a malfunction occurs, a message will appear on the display of the controller.



Directional pad flashes red.

Sensor fault. The error code **!Sensor fault** is displayed instead of a temperature on the sensor display channel.

Short circuit or line break
Disconnected temperature sensors can be checked with an ohmmeter. Please check if the resistance values correspond with the table.

°C	°F	Ω Pt500	Ω Pt1000	Ω KTY	°C	°F	Ω Pt500	Ω Pt1000	Ω KTY
-10	14	481	961	1499	55	131	607	1213	2502
-5	23	490	980	1565	60	140	616	1232	2592
0	32	500	1000	1633	65	149	626	1252	2684
5	41	510	1019	1702	70	158	636	1271	2778
10	50	520	1039	1774	75	167	645	1290	2874
15	59	529	1058	1847	80	176	655	1309	2971
20	68	539	1078	1922	85	185	664	1328	3071
25	77	549	1097	2000	90	194	634	1347	3172
30	86	559	1117	2079	95	203	683	1366	3275
35	95	568	1136	2159	100	212	693	1385	3380
40	104	578	1155	2242	105	221	702	1404	3484
45	113	588	1175	2327	110	230	712	1423	3590
50	122	597	1194	2413	115	239	721	1442	3695

WARNING! Electric shock!



Upon opening the housing, live parts are exposed!

→ **Always disconnect the controller from power supply before opening the housing!**

The controller is protected by a fuse. The fuse holder (which also holds the spare fuse) becomes accessible when the cover is removed. To replace the fuse, pull the fuse holder from the base.

The display is permanently off.

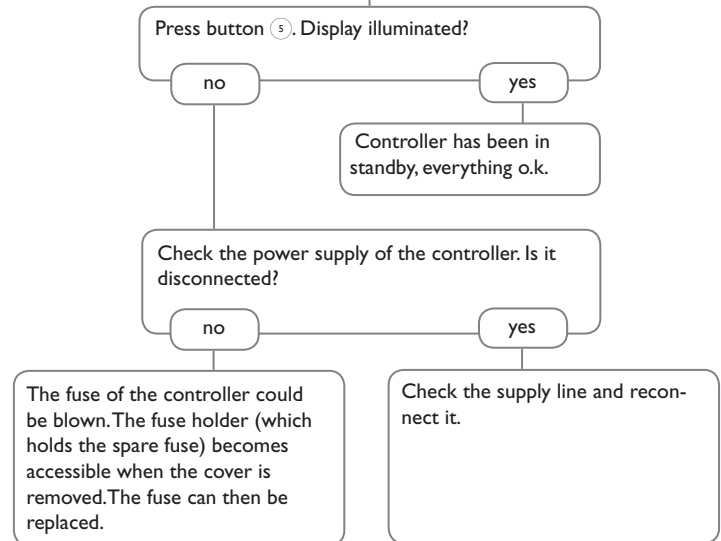

Pump is overheated, but no heat transfer from the collector to the store, flow and return have the same temperature; perhaps also bubbling in the lines.

Air or gas bubbles in the system?

no

yes

Is the collector circuit blocked at the dirt trap?

yes

Vent the system; increase the system pressure to a static primary pressure of at least plus 0.5 bar; if necessary continue to increase pressure; switch the pump on and off for a short time.

Clean dirt trap

Pump starts for a short moment, switches off, switches on again, etc.

Temperature difference at the controller too small?

no

yes

Wrong position of collector sensors?

no

yes

Plausibility control of the option tube collector special function

Change ΔT_{on} and ΔT_{off} correspondingly.

no

o.k.

Mount the collector sensor at solar flow (warmest collector output); use immersion sleeve of the respective collector.

Pump starts up very late.

Switch-on temperature difference ΔT_{on} too large?

no

yes

Non-ideal position of the collector sensor (e.g. flatscrew sensor instead of sensor in immersion sleeves).

yes

Change ΔT_{on} and ΔT_{off} correspondingly.

Activate tube collector function if necessary.

o.k.

The temperature difference between store and collector increases enormously during operation; the collector circuit cannot dissipate the heat.

Collector circuit pump defective?

no

yes

Heat exchanger calcified?

no

yes

Heat exchanger blocked?

no

yes

Heat exchanger too small?

yes

Check / replace it

Decalcify it

Clean it

Replace with correctly sized one.

The solar circuit pump does not work, although the collector is considerably warmer than the store.

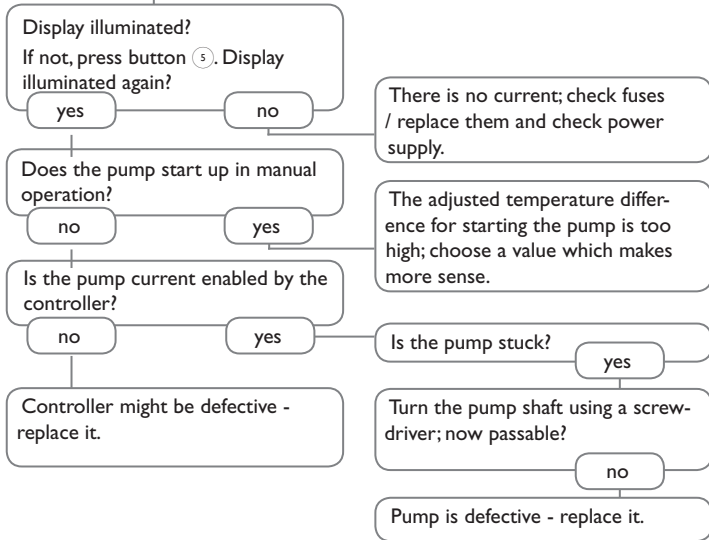

Stores cool down at night.

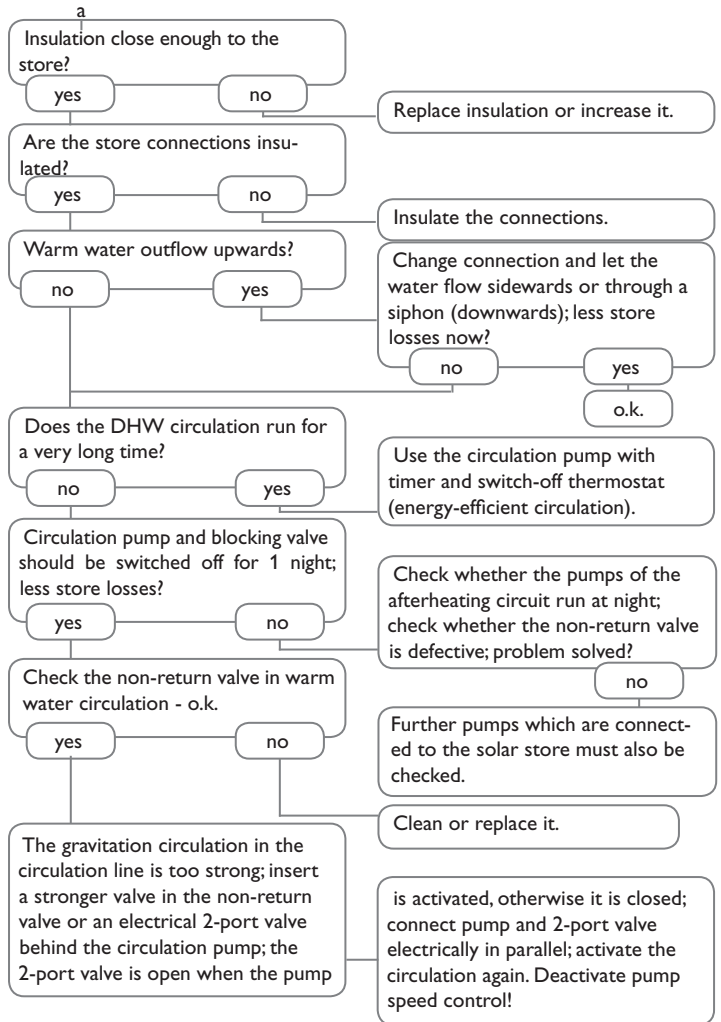
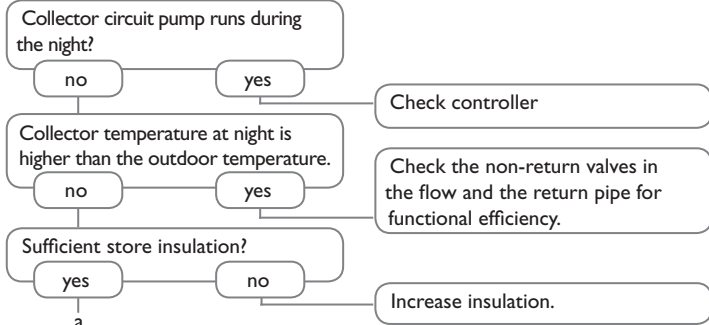

18 Accessories

18.1 Sensors and measuring instruments



Temperature sensors

The product range includes high-precision platinum temperature sensors, flatscrew sensors, outdoor temperature sensors, indoor temperature sensors, cylindrical clip-on sensors, also as complete sensors with immersion sleeve.



Overvoltage protection device

In order to avoid overvoltage damage at collector sensors (e.g. caused by local lightning storms), we recommend installing the overvoltage protection SP10.



V40 flowmeter

The V40 is a measuring instrument for detecting the flow of water or water/glycol mixtures. After a specific volume has passed, the V40 reed switch sends an impulse to the calorimeter. The heat quantity used is calculated by the calorimeter using these impulses and the measured temperature difference with the help of pre-defined parameters (glycol type, concentration, heat capacity, etc.).

18.2 VBus® accessories



Smart Display SD3 / Large Display GA3

The RESOL Smart Display is designed for simple connection to RESOL controllers with RESOL VBus®. It is used for visualising data issued by the controller: collector temperature, store temperature and energy yield of the solar thermal system. The use of high-efficiency LEDs and filter glass assures a high optical brilliance. An additional power supply is not required. One module is required per controller.

The RESOL GA3 is a completely mounted large display module for visualisation of collector- and store temperatures as well as the heat quantity yield of the solar system via one 6-digit and two 4-digit 7-segment-displays. An easy connection to all controllers with a VBus® is possible. The front plate is made of antireflective filterglass and is printed with a light-resistant UV-lacquering. The universal VBus® allows the parallel connection of 8 large displays as well as additional VBus®-modules.



AM1 Alarm module

The AM1 Alarm Module is designed to signal system failures. It is to be connected to the VBus® of the controller and issues an optical signal via the red LED if a failure has occurred. The AM1 also has a relay output, which can e. g. be connected to a building management system (BMS). Thus, a collective error message can be issued in the case of a system failure.

Depending on the controller and the sensors connected, different fault conditions can be signalled, e. g. sensor failures, excess or negative system pressure as well as errors in the flow rate, such as a dry run of the pump.

The AM1 Alarm module ensures that occurring failures can be immediately recognised and repaired, even if the system and the controller are difficult to access or located in a remote place. Thus, the reliability and the stable yield of the system are ensured.



EM Extension module

The EM Extension module offers 5 additional relay outputs and 6 additional sensor inputs for the SC5.14.



DL2 Datalogger

This additional module enables the acquisition and storage of large amounts of data (such as measuring and balance values of the solar system) over a long period of time. The DL2 can be configured and read-out with a standard Internet browser via its integrated web interface. For transmission of the data stored in the internal memory of the DL2 to a PC, an SD card can be used. The DL2 is appropriate for all controllers with VBus®. It can be connected directly to a PC or router for remote access and thus enables comfortable system monitoring for yield monitoring or for diagnostics of faults.



DL3 Datalogger

Be it solar thermal, heating or DHW heat exchange controllers – with the DL3 you can easily and conveniently log system data of up to 6 controllers. Get a comprehensive overview of all controllers connected with the large full graphic display. Transfer data with an SD memory card or use the LAN interface to view and process data on your PC.

18.3 Interface adapters



VBus®/USB & VBus®/LAN interface adapters

The new VBus® / USB interface adapter is the interface between the controller and a personal computer. With its standard mini-USB port it enables a fast transmission of system data for processing, visualising and archiving data via the VBus®. A full version of the ServiceCenter software is included.

The VBus® / LAN interface adapter is designed for the direct connection of the controller to a PC or router. It enables easy access to the controller via the local network of the owner. Thus, controller access and data charting can be effected from every workstation of the network. The VBus® / LAN interface adapter is suitable for all controllers equipped with a VBus®. A full version of the ServiceCenter software is included.

A	
Afterheating suppression.....	38
Antifreeze, solar optional function.....	37
B	
Balance values	30
Bypass, solar optional function.....	34
C	
Chimney sweeper function.....	59
Circulation	51
Collector cooling, Cooling mode.....	39
Collector emergency temperature.....	31
Commissioning menu.....	13
Controller adjustments, loading of.....	65
Cooling mode	39
CS-Bypass	35
D	
Data logging.....	65
Day/Night operation, heating circuit.....	56
ΔT function.....	54
DHW heating.....	62
Drainback option	41
E	
Error messages	29
Error messages, acknowledgement of.....	29
Error relay.....	49
External heat exchanger, solar optional function.....	40
F	
Flow rate monitoring	43
Formatting the SD card	65
Function block	54
Fuse, replacing of.....	71

H	
Heat dump.....	42
Heat exchange.....	50
Heating circuits, internal.....	56
Heating demands.....	56
Heat quantity measurement.....	63
I	
Irradiation switch	55
M	
Mains connection	7
Manual mode.....	66
Maximum store temperatures	32
Measured values	30
Minimum collector limitation.....	31
Mixer, optional arrangement function	48
Modules, registration of.....	67
O	
Offset.....	68
Operating hours counter	30
Operating mode, relays.....	66
Overpressure	44
P	
Parallel relay, optional arrangement function.....	48
Parallel relay, solar optional function	38
Pressure monitoring.....	44
Priority logic.....	32
Progression chart.....	30
PWM pump speed control	69

R

Registering external modules.....	67
Return preheating.....	53
Room thermostat.....	57

S

Sensor offset.....	68
Solar external heat exchanger.....	40
Solid fuel boiler.....	50
Store cooling, Cooling mode.....	39
Store loading.....	49
Store set temperature.....	32
Storing controller adjustments.....	65
System cooling, Cooling mode.....	39, 45

T

Target temperature, solar optional function.....	37
Technical data.....	4
Thermal disinfection.....	61
Thermostat function.....	54
Tube collector function.....	36
Twin pump.....	42

U

User code.....	67
----------------	----

Distributed by:

PAW GmbH & Co. KG

Böcklerstraße 11

31789 Hameln

Tel.: +49 (0) 51 51/98 56 - 0

Fax: +49 (0) 51 51/98 56 - 98

www.paw.eu

info@paw.eu