

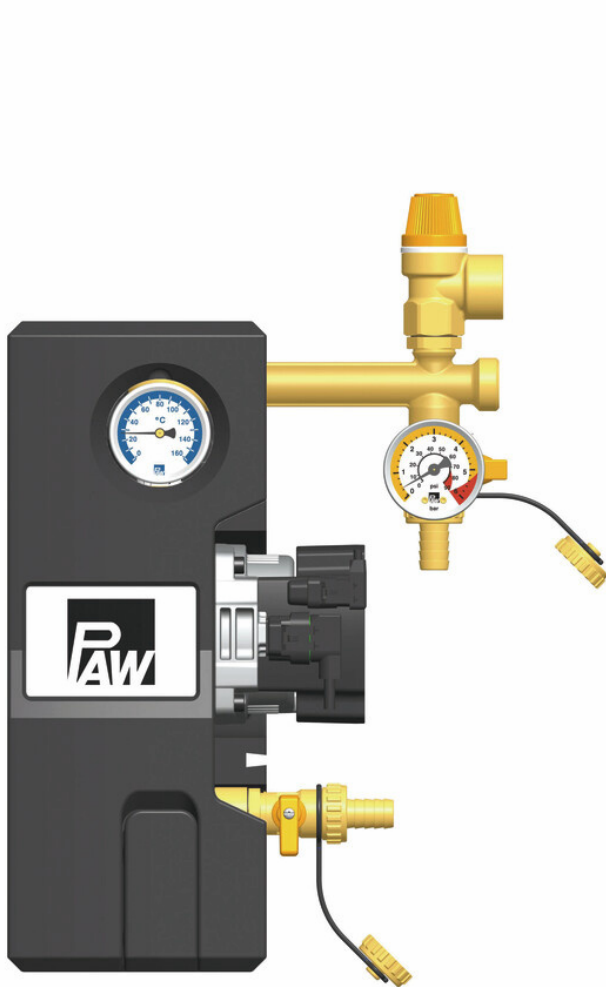

## Installation and Operation Instructions return station

**SolarBloC® midi Basic - DN 20**

**SolarBloC® maxi Basic - DN 25**



SolarBloC midi  
DN 20

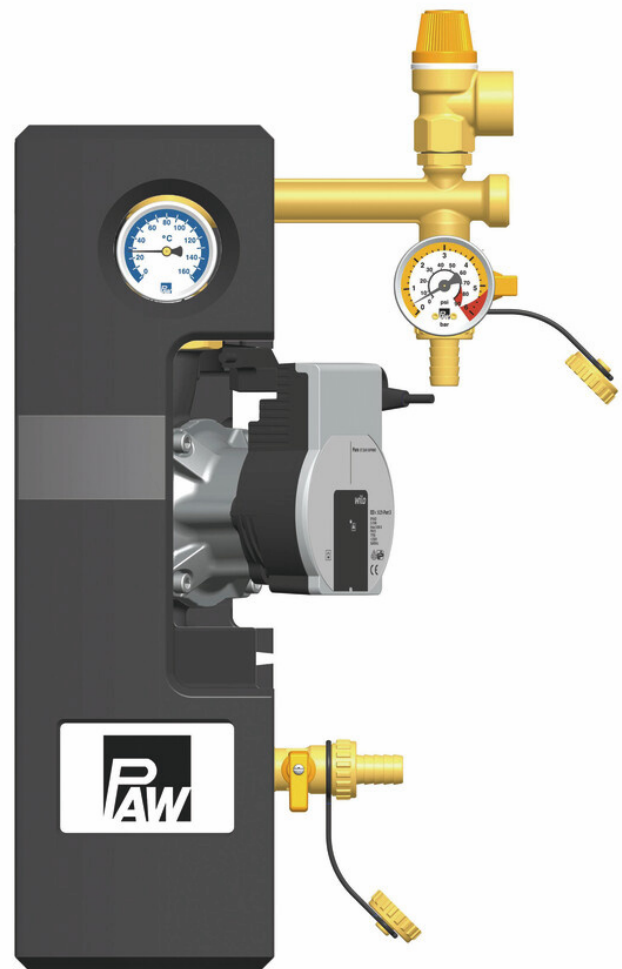

SolarBloC maxi  
DN 25

## Table of Contents

<b>1</b>	<b>General Information.....</b>	<b>3</b>
<b>1.1</b>	<b>About these instructions.....</b>	<b>3</b>
<b>1.2</b>	<b>About this product.....</b>	<b>3</b>
<b>1.3</b>	<b>Designated use.....</b>	<b>4</b>
<b>2</b>	<b>Safety instructions.....</b>	<b>5</b>
<b>3</b>	<b>Mounting and installation [specialist].....</b>	<b>7</b>
<b>4</b>	<b>Commissioning [specialist].....</b>	<b>10</b>
<b>4.1</b>	<b>Flushing and filling the solar circuit.....</b>	<b>11</b>
<b>4.2</b>	<b>Preparations before flushing.....</b>	<b>13</b>
<b>4.3</b>	<b>Flushing and filling.....</b>	<b>13</b>
<b>4.4</b>	<b>Setting the solar installation.....</b>	<b>15</b>
<b>5</b>	<b>Maintenance [specialist].....</b>	<b>16</b>
<b>5.1</b>	<b>Replacement / adjustment of the pressure gauge.....</b>	<b>16</b>
<b>5.2</b>	<b>Draining the solar system.....</b>	<b>17</b>
<b>5.3</b>	<b>Deinstallation.....</b>	<b>18</b>
<b>6</b>	<b>Scope of delivery [specialist].....</b>	<b>19</b>
<b>6.1</b>	<b>SolarBloC® midi Basic DN 20.....</b>	<b>19</b>
<b>6.2</b>	<b>SolarBloC® maxi Basic DN 25.....</b>	<b>21</b>
<b>6.3</b>	<b>SolarBloC® maxi Basic DN 25 for Grundfos Solar PML and Wilo Para MAXO.....</b>	<b>23</b>
<b>7</b>	<b>Technical data.....</b>	<b>25</b>
<b>7.1</b>	<b>Dimensional drawing SolarBloC® midi Basic DN 20.....</b>	<b>26</b>
<b>7.2</b>	<b>Dimensional drawing SolarBloC® maxi Basic DN 25.....</b>	<b>26</b>
<b>7.3</b>	<b>Pressure drop and pump characteristic curves SolarBloC® midi Basic DN 20.....</b>	<b>27</b>
<b>7.4</b>	<b>Pressure drop and pump characteristic curves SolarBloC® maxi Basic DN 25.....</b>	<b>27</b>
<b>8</b>	<b>Function of the check valves [Expert].....</b>	<b>28</b>
<b>9</b>	<b>Disposal.....</b>	<b>30</b>
<b>10</b>	<b>Commissioning report.....</b>	<b>31</b>

### 1 General Information



Carefully read these instructions before installation and commissioning.

Save these instructions in the vicinity of the installation for future reference.

#### 1.1 About these instructions

These instructions describe the function, installation, commissioning and operation of the return stations SolarBloC® midi Basic and maxi Basic.

The chapters called [specialist] are intended for specialists only.

For other components of the solar installation, such as pumps, collectors, storage tanks, expansion tanks and controllers, please observe the instructions of the corresponding manufacturer.

#### 1.2 About this product

The station is a group of fittings checked for tightness and premounted (apart from the versions with the Wilo Maxo pump and Grundfos Solar PML pump) used to circulate the solar fluid in the solar circuit. It is mounted on a wall bracket and fixed with clips.

The station contains important valves, fittings and safety devices for the operation of the installation:

- Ball valve with exchangeable spindle
- Check valve
- Thermometer
- Pressure gauge to display the installation pressure
- Flowmeter to display the flow rate
- Ball valve to restrict the flow rate
- Solar pressure relief valve
- Connection for expansion vessel
- Flush and fill valves

### 1.3 Designated use

The solar station may only be used in solar thermal systems as a pump station in the solar circuit, taking into consideration the technical limit values indicated in these instructions. Due to its design, the station may only be installed and operated as described in these instructions!

Improper usage excludes any liability claims.

This product complies with the relevant directives and is therefore labelled with the CE mark.

The Declaration of Conformity is available upon request, please contact the manufacturer.

Only use PAW accessories with the product.

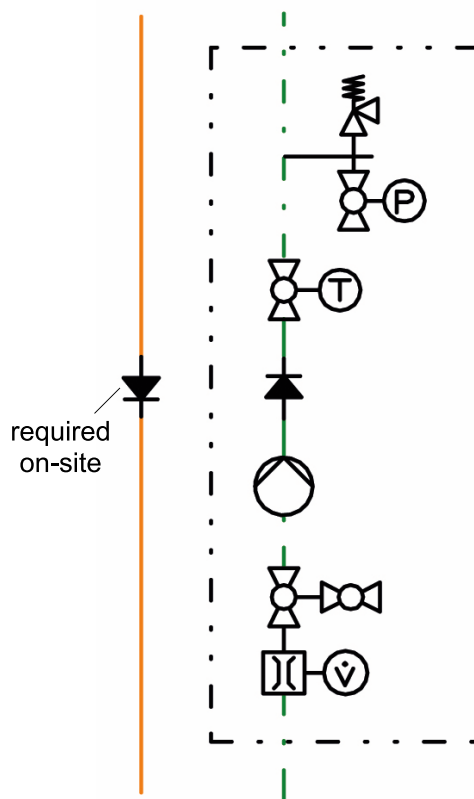

### NOTICE

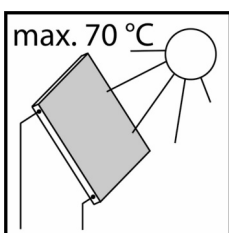

Under the influence of solar radiation, the collectors will heat up considerably. The solar fluid in the solar circuit may heat up to more than 100 °C. Only flush and fill the solar circuit when the collector temperatures are below 70 °C.



## 2 Safety instructions

The installation and commissioning as well as the connection of electrical components require technical knowledge commensurate with a recognised vocational qualification as a fitter for plumbing, heating and air conditioning technology, or a profession requiring a comparable level of knowledge [specialist].

The following must be observed during installation and commissioning:

- relevant local and national regulations
- accident prevention regulations of the professional association
- instructions and safety instructions mentioned in these instructions

<b>WARNING</b>	
	<p><b>Danger of scalding due to the escape of hot fluids!</b></p> <p>With pressure relief valves, there is a risk of scalding due to the escape of vapour or hot fluid.</p> <p>Please ensure for each pressure relief valve that no personal injury or material damage may occur due to possibly escaping medium.</p> <ul style="list-style-type: none"> <li>▶ Install a discharge line.</li> <li>▶ Observe the instructions regarding the pressure relief valve.</li> <li>▶ The pressures for the expansion tank calculated by the plant designer and the operating pressure of the installation must be set.</li> </ul>

 <b>CAUTION</b>	
	<p><b>Risk of burns!</b></p> <p>The valves and fittings and the pumps can become heated up to more than 100 °C during operation.</p> <ul style="list-style-type: none"> <li>▶ The insulating shell must remain closed during operation.</li> </ul>

 **CAUTION**



**Personal injury and material damage due to overpressure!**

Closing both ball valves in the primary circuit will separate the safety group from the heat exchanger. A rise in temperature in the storage tank may result in high pressures, which may lead to personal injury and material damage!

- ▶ Only close the ball valves for service and maintenance.

**NOTICE**

**Material damage due to mineral oils!**

Mineral oil products cause lasting damage to seals made of EPDM, whereby the sealant properties are lost. We do not assume liability nor provide warranty for damage to property resulting from sealants damaged in this way.

- ▶ It is imperative to prevent the EPDM sealing elements from making contact with substances containing mineral oils.
- ▶ Use a silicone- or polyalkylene-based lubricant free of mineral oil such as Unisilikon L250L and Syntheso Glep 1 from Klüber or a silicone spray.

## 3 Mounting and installation [specialist]

### NOTICE

#### Material damage due to high temperatures!

Since the solar fluid near the collector can be very hot, the group of fittings must be installed at a sufficient distance from the collector field. It may be necessary to install an intermediate tank in order to protect the expansion tank.

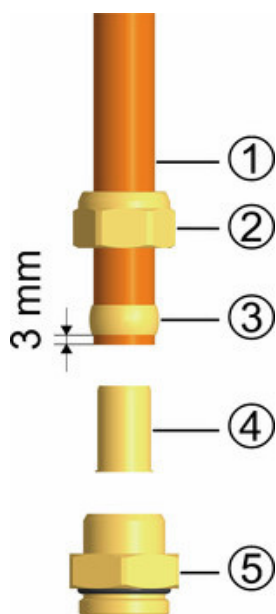

Not included in the scope of delivery!

#### Accessories: compression fitting

1. Push the union nut ② and the cutting ring ③ onto the copper pipe ①. The pipe must protrude at least 3 mm from the cutting ring in order to ensure the force transmission and the sealing.
2. Insert the support sleeve ④ into the copper pipe.
3. Insert the copper pipe with the plugged-on individual parts (②, ③ and ④) as far as possible into the body of the compression fitting ⑤.
4. First, screw the union nut ② manually.
5. Tighten the union nut ② by rotating one full turn. Secure the body of the compression fitting ⑤ against distort in order to avoid damaging the sealing ring.

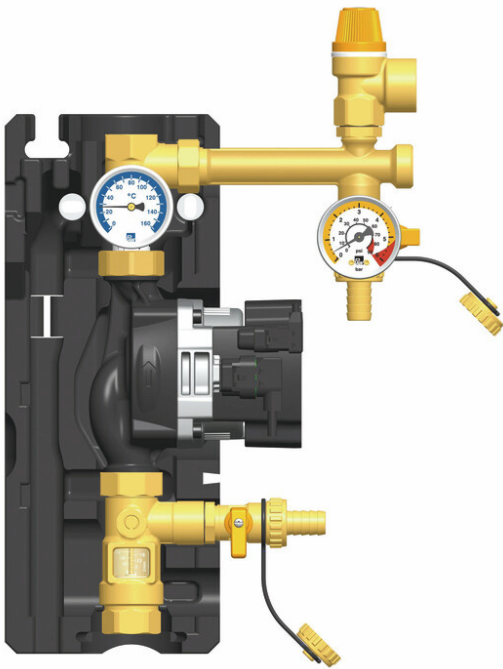

1. Remove the station from the packaging.
2. Remove the insulating front shell.

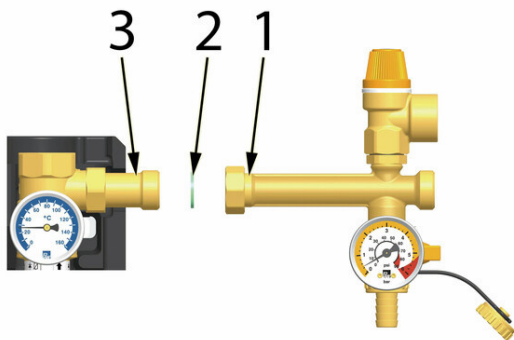

3. **Only for version with Wilo Para MAXO pump / Grundfos Solar PML pump:** Mount the enclosed safety group for completion and prior to commissioning. For this, screw the union nut (1) of the safety bar onto the distance piece (3) by using the corresponding gasket (2).

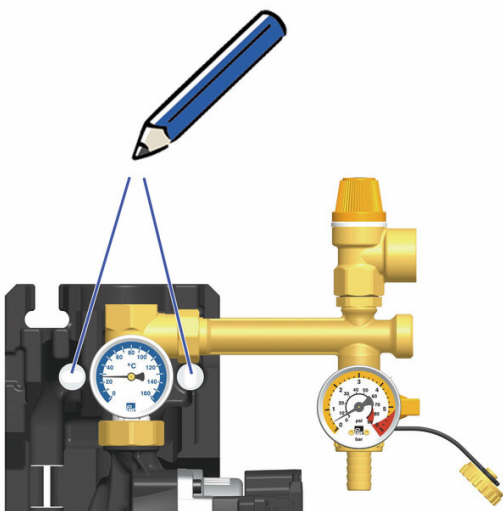

4. Copy the dimension of the mounting holes of the solar station on the mounting surface.
5. Drill the holes and mount the solar station to the wall with suitable wall plugs and screws.



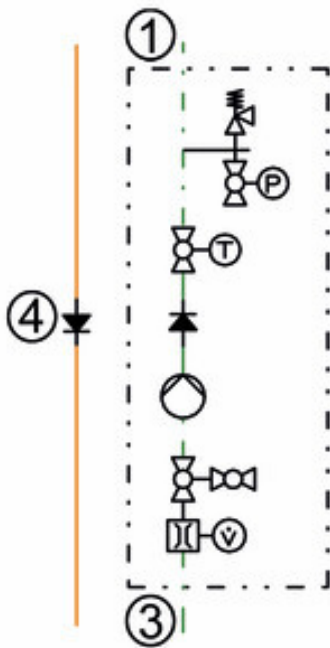

6. Connect the solar station to the installation by using the pipes

- ① Return to the collector field
- ③ Return from the storage tank

All thread connections have  $\frac{3}{4}$ " internal threads for DN 20 and 1" internal threads for DN 25.

7. In order to prevent unwanted circulation, it is mandatory to mount an additional check valve ④ in the flow on site.

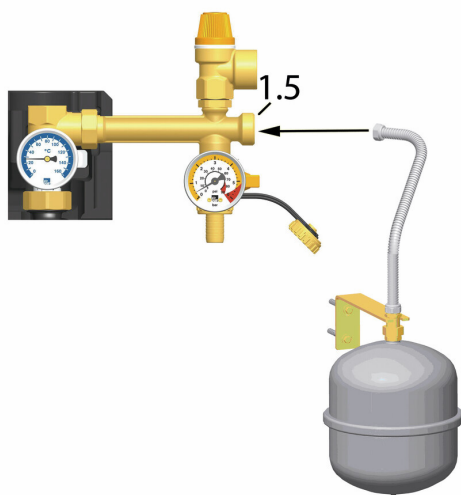

8. Connect the pipe for the expansion tank [1.5] and fix the bracket for the expansion tank.

9. Adapt the initial pressure of the expansion tank to the system and connect the expansion tank. Observe the separate instructions for the expansion tank!



10. Check all thread connections and tighten them if necessary.

The expansion tank is not included in the scope of delivery!

The assembly of the solar station is now completed and the station can be put into operation.

## 4 Commissioning [specialist]

Please observe the following safety instructions regarding the commissioning of the station:

<b>WARNING</b>	
 	<p><b>Risk of burning and scalding!</b></p> <p>The valves and fittings may heat up to more than 100 °C. Therefore, do not clean or fill the system when the collectors are hot (intense sunshine). Please note that hot solar fluid leaks from the pressure relief valves in case of too high system pressure!</p> <p>During venting the solar fluid may escape as vapour and result in scalding!</p> <ul style="list-style-type: none"> <li>▶ Flush and fill the system only when the collector temperatures are below 70 °C.</li> </ul>

<b>NOTICE</b>	
<p><b>Risk of frost!</b></p> <p>It often happens that solar systems cannot be completely drained after flushing. Thus, there is a risk of frost damage later on when flushing with water. Therefore, only use the solar fluid used later on for flushing and filling the solar installation.</p> <ul style="list-style-type: none"> <li>▶ Use a water/propylene glycol mixture with max. 50% of propylene glycol as solar fluid.</li> </ul>	

<b>NOTICE</b>	
<p><b>Note regarding the commissioning sequence</b></p> <p>During commissioning, fill the heating circuit first and the solar circuit afterwards. This guarantees that the heat possibly absorbed by the collectors during commissioning can be dissipated.</p>	

<b>NOTICE</b>	
<p><b>Note regarding the expansion tank</b></p> <p>The expansion tank must not be connected while flushing and filling in order to prevent dirt particles from being flushed in. Please observe the instructions of the manufacturer.</p>	

## 4 Commissioning [specialist]

### 4.1 Flushing and filling the solar circuit

The fill and drain valves necessary to flush and fill the installation are integrated in the solar station. Make sure not to wash dirt particles that may be present in the solar installation into the expansion tank. To do so, it may be necessary to disconnect the expansion tank during flushing and filling and to use only flushing and filling stations that are equipped with suitable microfilters.

#### Ball valve with integrated flow check valve

(normal flow direction in the figure: downwards)

**position 0°**

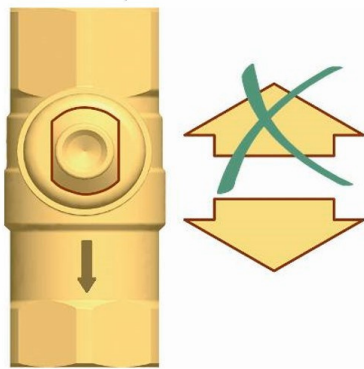

Check valve is operating,  
**flow only in flow direction.**

**position 45°**

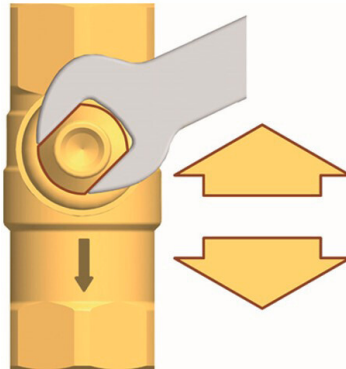

Check valve not operating,  
**flow in both directions.**

**position 90°**

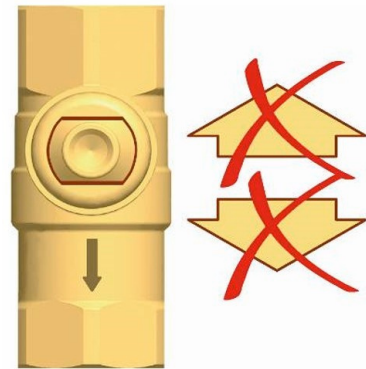

Ball valve closed,  
**no flow.**

**Functions of the fill and drain valve within the safety group**

**Position**

**Function**



**Position "closed" (station in operation):**

Fill and flush circuit is closed. Pressure gauge indicates system pressure.



**Position "open" (fill and flush processes):**

Fill and flush circuit is open. Pressure gauge indicates pressure.

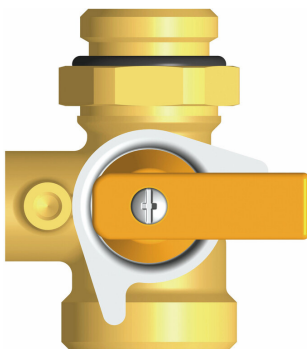

**Position "maintenance" (maintenance work):**

Fill and flush circuit is closed. Pressure gauge indicates, after removal of cap, no pressure.

Attention: Remove stop bolt before changing the position!

### 4.2 Preparations before flushing

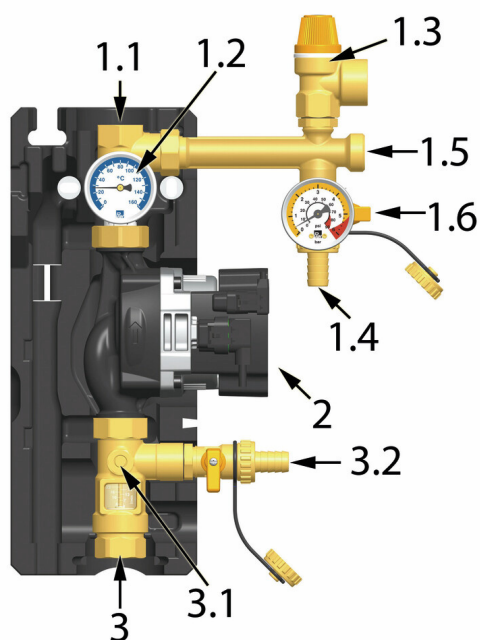

The solar circuit is flushed in the direction of flow.

1. Disconnect the expansion tank from the solar system. Observe the separate instructions for the expansion tank!
2. Close the return ball valve [1.2] (90°, see chapter 4.1).
3. The ball valve [3.1] at the flow meter must be open.
4. Connect the fill station to the solar station:
  - pressure hose to the fill valve [1.4]
  - flush hose to the drain valve [3.2]

### 4.3 Flushing and filling

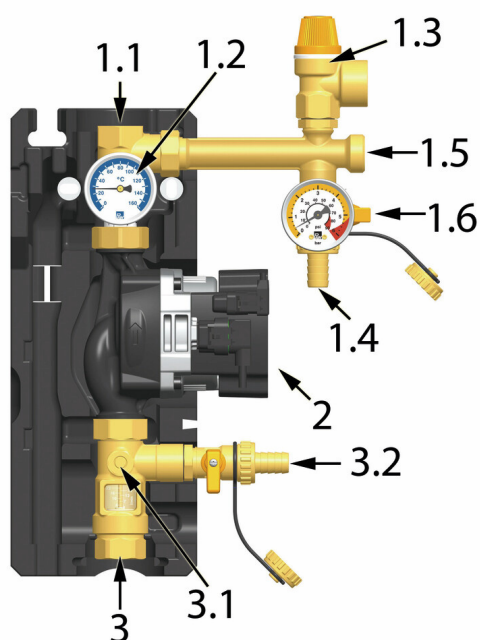

1. Open the fill and drain valves [1.4|3.2]. For this, turn the valve [1.4] into position "open" (see chapter 4.1).
2. Put the flush and fill station into operation and flush the installation until the solar fluid exits without bubbles.
3. During flushing, vent the solar installation several times via the vent valves possibly present.
4. Slowly open the return ball valve [1.2] to vent the pump section.

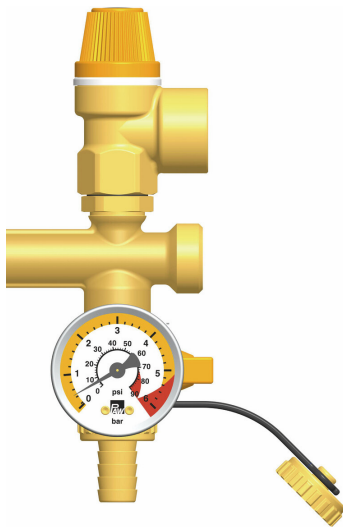

5. Close the drain valve [3.2] while the filling pump is running and increase the system pressure to about 5 bars. The system pressure is displayed on the pressure gauge. Close the fill valve [1.4] by turning it into position "closed" (see chapter 4.1) and switch off the pump of the flush and fill station.
6. Check the pressure gauge to see whether the system pressure reduces and eliminate leaks where necessary.
7. Reduce the pressure at the drain valve [3.2] to the operating pressure.
8. Connect the expansion tank to the solar circuit and set the operating pressure of the solar installation by means of the flush and fill station (for the required operating pressure, see instructions of the expansion tank).
9. Close the fill and drain valves [1.4|3.2]. For this, turn the valve [1.4] into position "closed" (see chapter 4.1).
10. Turn the check valve in the return ball valve [1.2] into operating position (0°, see chapter 4.1).
11. Connect the additionally required controller to the mains and set the solar circuit pump to ON in the manual mode (see the controller instructions).
12. Remove the hoses of the flush and fill station and screw the sealing caps on the fill and drain valves.



The closure caps are only for protection against contamination. They are not designed for high system pressures.

Their tightness is ensured by the closed ball valves.

## 4 Commissioning [specialist]

### 4.4 Setting the solar installation

1. Set the desired revolution speed of the solar pump depending on the required flow rate.  
If necessary, the flow rate can be reduced by the ball valve [3.1] (only necessary if the pump is not speed-controlled). Please observe the specifications of the collector manufacturer for the correct adjustment of the flow rate.
2. Mount the insulating front shells of the solar station.
3. Switch the controller to automatic mode (see controller instructions).

The commissioning of the solar installation is now completed. Please fill in completely the commissioning log.

Reading edge = **round edge** of  
the float

**Example: approx. 4 l/min**

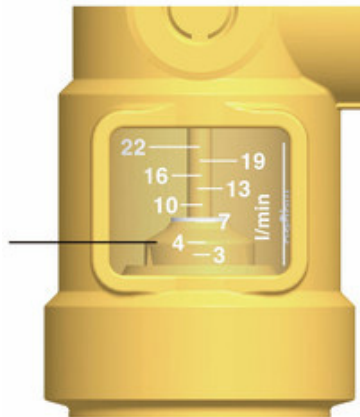

**Scale DN 20:**

3 – 22 l/min

**Scale DN 25:**

5 - 40 l/min

## 5 Maintenance [specialist]

### WARNING



#### Risk of burning and scalding!

The valves and fittings and the solar fluid can have temperatures of more than 100 °C. The solar fluid may escape as vapour and result in scalding.

- ▶ Perform maintenance work only when the collector temperatures are below 50 °C.
- ▶ Wait until the solar fluid has cooled down to at least 50 °C.

### 5.1 Replacement / adjustment of the pressure gauge

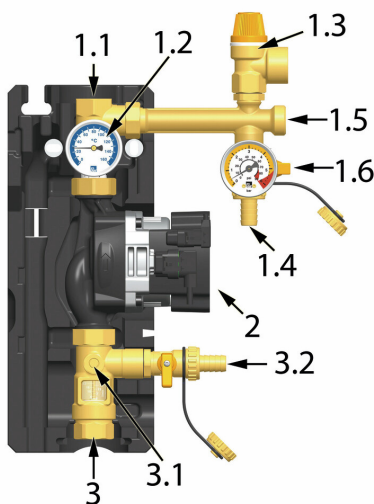

1. Switch off the controller and secure it against being switched on again.
2. Make sure that the valve [1.4] is closed with cap.
3. Turn the valve [1.4.] in position "maintenance" by removing the stop screw (see chapter 4.1).

#### 4. Replacement of the pressure gauge:

Dismount the pressure gauge [1.6]. It can happen that a small amount of fluid leaks out (valve content). After that, exchange the pressure gauge.

#### Adjustment of the pressure gauge:

Loosen the counter nut and turn the pressure gauge (from completely screwed in to max. 360°) anti-clockwise. After that, secure it with the counter nut.

5. Turn the valve [1.4] again in position "closed" (see chapter 4.1). During this, mount the stop screw.
6. Check the pressure gauge [1.6] for tightness. Also, check the system pressure and increase it to the prescribed operating pressure, if necessary.
7. Vent the installation. Repeat that weekly or monthly, depending on the vented air quantity.



5.2 Draining the solar system

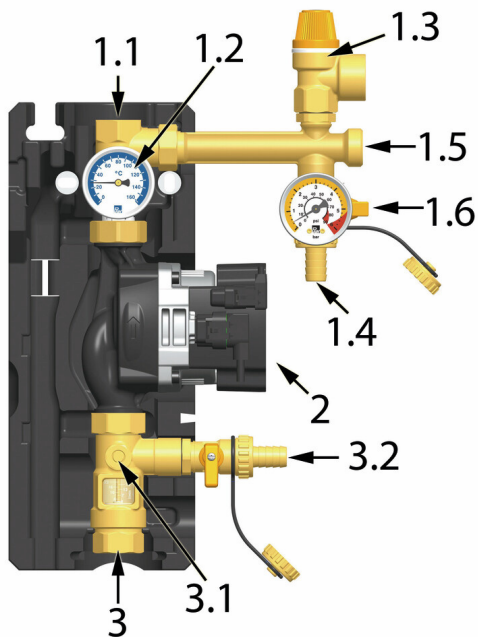

1. Switch off the controller and secure it against being switched on again.
2. Open the check valve in the return ball valve [1.2] by turning the ball valve into position 45° (see chapter 4.1).

Open the check valve possibly present in the flow line.

3. Connect a heat-resistant hose to the lowest drain valve of the solar installation (possibly drain valve [3.2]). Make sure that the solar fluid is collected in a heat-resistant container.

**WARNING**



**Danger of scalding due to hot solar fluid!**

The escaping solar fluid can be very hot!

- ▶ Position and secure the heat-resistant collecting container such that persons nearby are not put at risk when the solar system is drained.

4. Open the drain valve at the lowest point of the solar installation.
5. Open the vent valve possibly present at the highest point of the solar installation.
6. Dispose of the solar fluid observing the local regulations.

### 5.3 Deinstallation

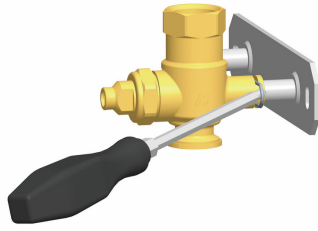

1. Drain the solar installation as described in the previous chapter.
2. Disconnect the pipe connections to the solar installation.
3. To remove the solar station from the mounting plate, pull out the clip springs laterally with a screwdriver.
4. Remove the station by pulling it forward.



Position	Spare part	Item number
3	<b>Alternative pumps:</b>	
	Wilo Para ST 15/7	N00150
	Wilo Para ST 15/13	N00299
	Grundfos UMP3 Solar 15-75	N00025
	Grundfos UMP3 Solar 15-145	N00215
4	Flowmeter $\frac{3}{4}$ ", 3-22 l/min, 1" M x $\frac{3}{4}$ " int. thread x $\frac{1}{2}$ ", with seal	N00225
5	Sealing kit, 30.0 x 21.0 x 2.0, $\frac{1}{2}$ ", for thread connection 1", 10 pieces	N00024
6	Union nut G1", passage 28.1 mm, wrench size 37	N00302
7	Return ball valve DN 20, $\frac{3}{4}$ " int. thread x F $\frac{3}{4}$ " x $\frac{3}{4}$ " ext. thread on the right	N00290
8	Dial thermometer, blue scale, d = 50 mm, 0-160 °C	N00194

## 6 Scope of delivery [specialist]

### 6.2 SolarBloC® maxi Basic DN 25

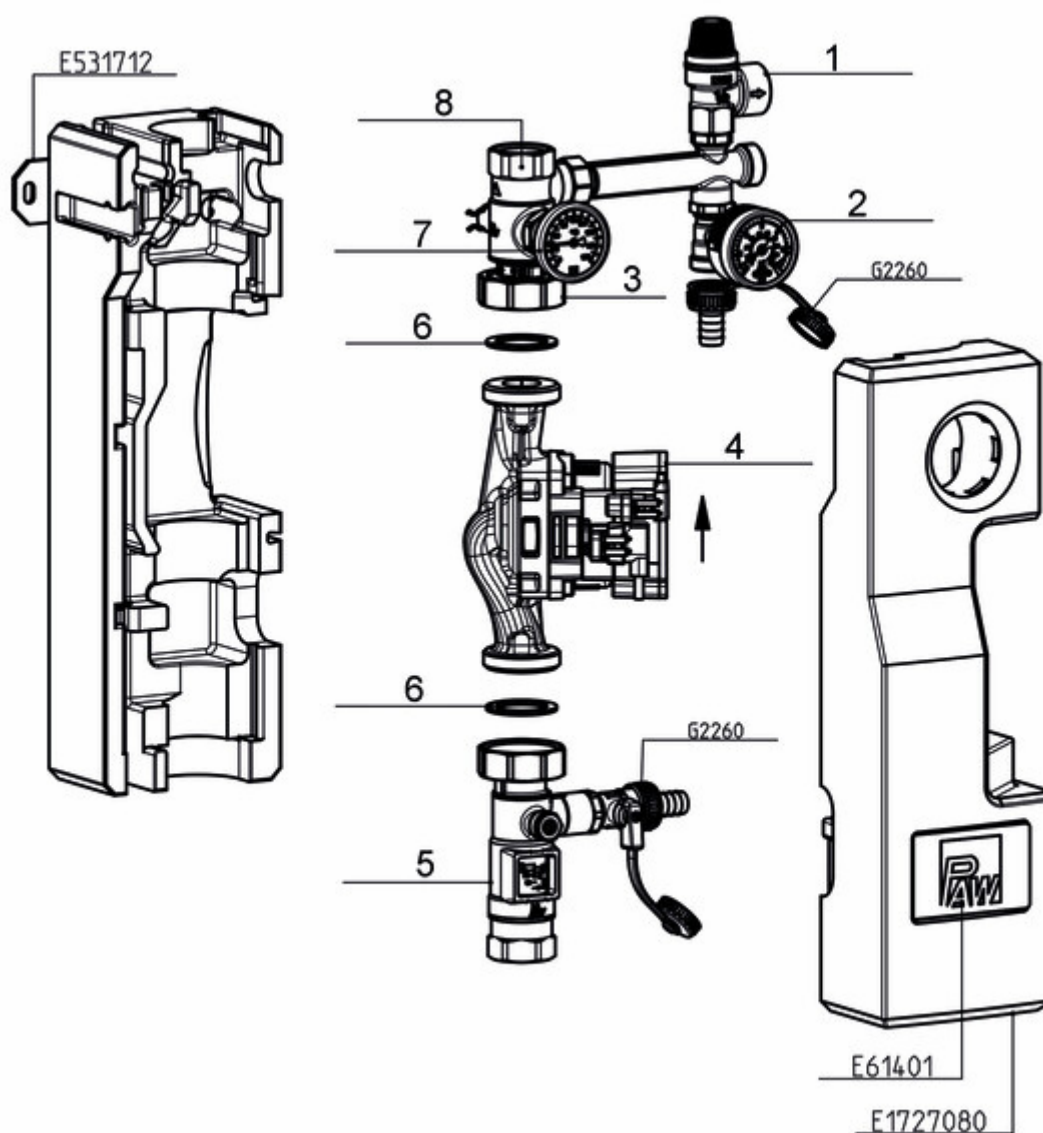

Position	Spare part	Item number
1	Pressure relief valve ½" x ¾", 6 bars	N00300
2	Pressure gauge 0-6 bars, G ¼" axial; d = 50 mm, 130 °C	N00337
3	Union nut G 1½", wrench size 52	N00269

Position	Spare part	Item number
4	<b>Alternative pumps:</b>	
	Wilo Para ST 25/8	N00263
	Grundfos UPM3 Solar 25-75	N00035
	Grundfos UPM3 Solar 25-145	N00304
5	Flowmeter 1", 5-40 l/min, 1½" union nut x 1" int. thread x ½" int. thread with fill and drain valve and seal	N00227
6	Sealing kit, 10 pieces, 1", for thread connection 1½"	N00036
7	Dial thermometer, blue scale, d = 50 mm, 0-160 °C	N00194
8	Return ball valve DN 25, F1" x 1" int. thread	N00306

## 6 Scope of delivery [specialist]

### 6.3 SolarBloC® maxi Basic DN 25 for Grundfos Solar PML and Wilo Para MAXO

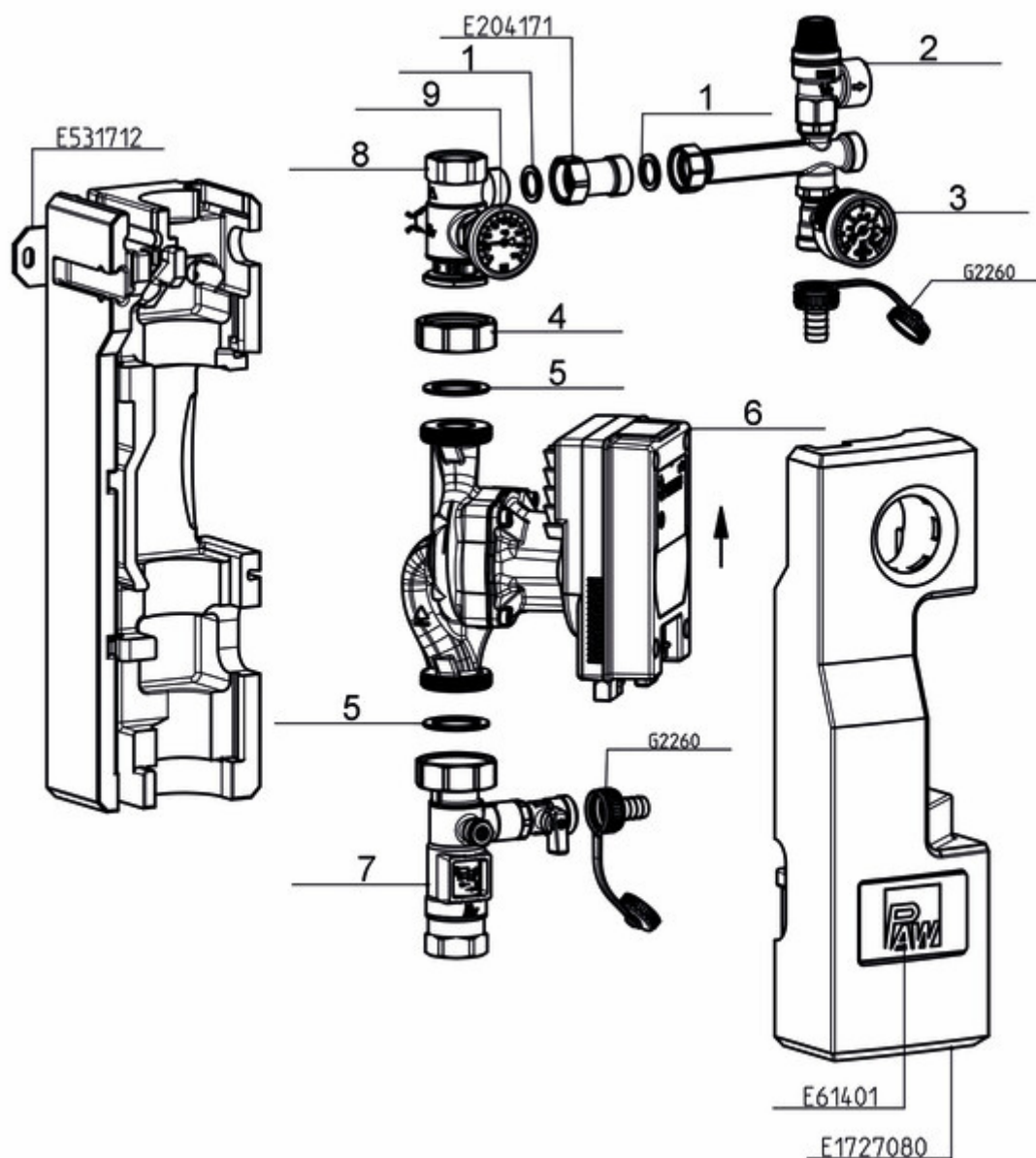

Position	Spare part	Item number
1	Sealing kit 24.0 x 17.0 x 2.0, ¼", for thread connection ¾", 10 pieces	N00030
2	Pressure relief valve ½" x ¾", 6 bars	N00300
3	Pressure gauge 0-6 bars, G ¼" axial; d = 50 mm, 130 °C	N00337
4	Union nut G 1½", wrench size 52	N00269
5	Sealing kit, 44.0 x 32.0 x 2.0, 1", for thread connection 1½", 10 pieces	N00036

Position	Spare part	Item number
6	<b>Alternative pumps:</b>	
	Wilo Para MAXO 25-180-11-F02	N00253
	Grundfos Solar PML 25-145	N00226
7	Flowmeter 1", 5-40 l/min, 1½" union nut x 1" int. thread x ½" int. thread with fill and drain valve and seal	N00227
8	Return ball valve DN 25, F1" x 1" int. thread	N00306
9	Dial thermometer, blue scale, d = 50 mm, 0-160 °C	N00194



## 7 Technical data

### 7 Technical data

Dimensions	SolarBloC® midi DN 20	SolarBloC® maxi DN 25
Height (with pressure relief valve)	383 mm	474 mm
Width (with fill and drain valve)	244 mm	246 mm / 286 mm (Wilо MAXO and Grundfos Solar PML)
Depth (with insulation)	150 mm	155 mm
Pipe connections	¾" internal thread	1" internal thread
Connection for expansion tank	¾" external thread, flat sealing	
Outlet of pressure relief valve	¾" internal thread	
<b>Operating data</b>		
Max. admissible pressure	6 bars	
Max. operating temperature	120 °C	
Max. short-time temperature	160 °C, < 15 minutes	
Max. propylene glycol content	50 %	
<b>Equipment</b>		
Pressure relief valve	6 bars	
Pressure gauge	0-6 bars	
Check valve	200 mm wc, can be opened	
Flow meters	3-22 l/min	5-40 l/min
<b>Materials</b>		
Valves and fittings	Brass	
Gaskets	EPDM	
Check valves	Brass	
Insulation	EPP, $\lambda = 0.041 \text{ W}/(\text{m K})$	

7.1 Dimensional drawing SolarBloC® midi Basic DN 20

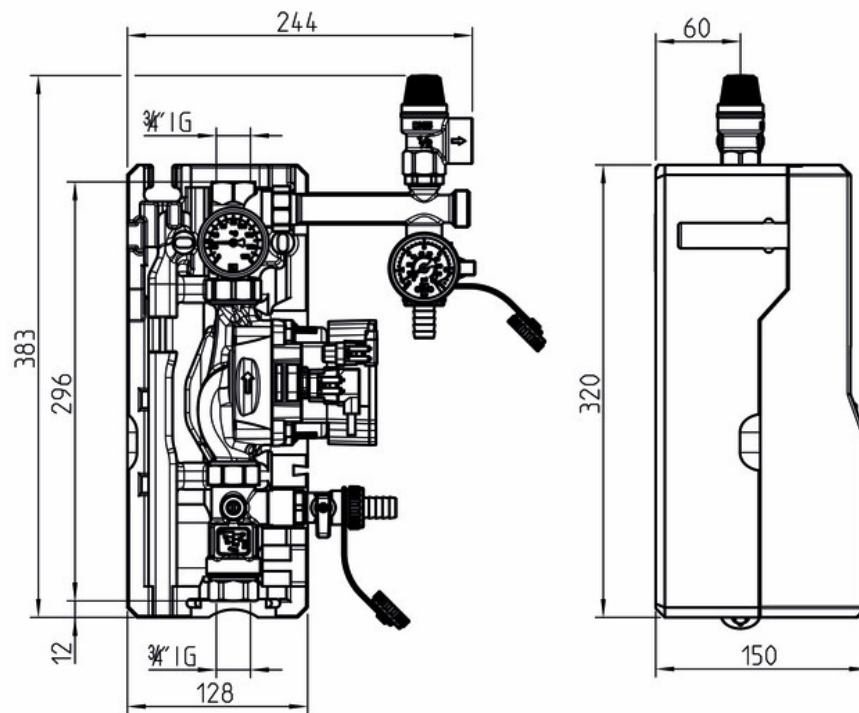

7.2 Dimensional drawing SolarBloC® maxi Basic DN 25

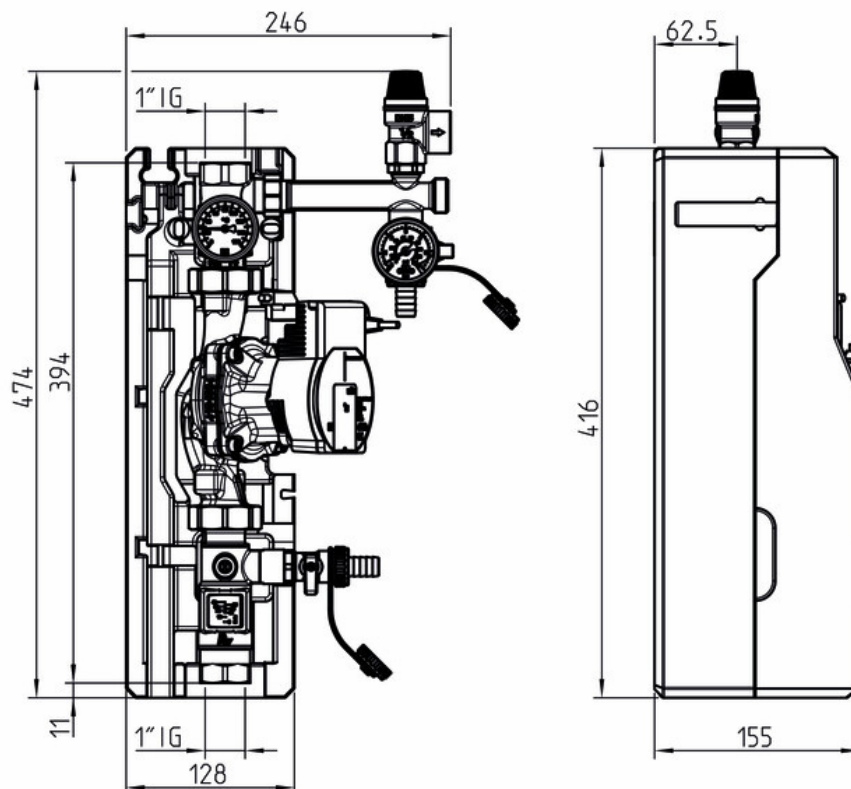

## 7 Technical data

### 7.3 Pressure drop and pump characteristic curves SolarBloC® midi Basic DN 20

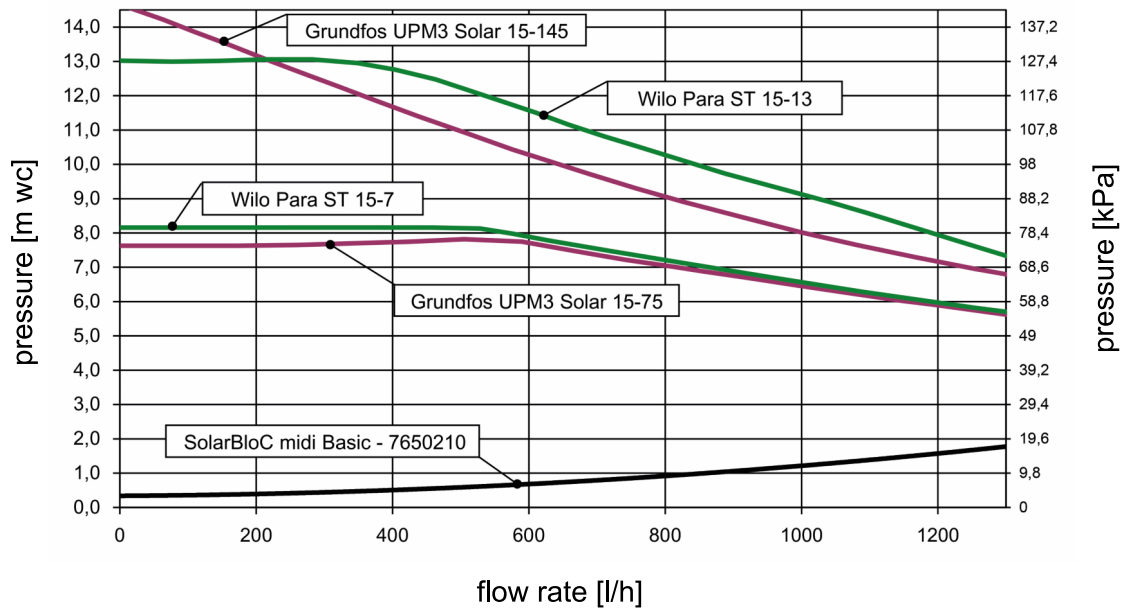

### 7.4 Pressure drop and pump characteristic curves SolarBloC® maxi Basic DN 25

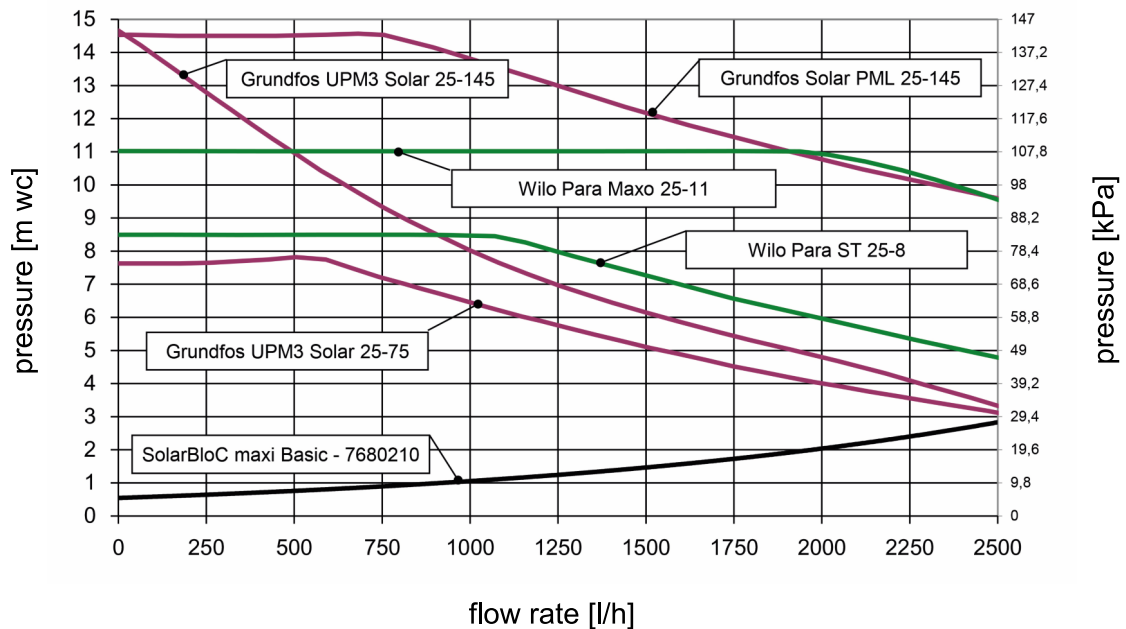

## 8 Function of the check valves [Expert]

The check valves in this station prevent unwanted gravity circulation within their range of use. The functioning of the check valves depends:

- on the system height
- on the temperature difference between storage tank and collector
- on the solar fluid used

The diagram below indicates if the check valves integrated in the station are sufficient for your installation. If the check valves are not sufficient, additional components must be installed to prevent gravity circulation. You can install, for example, syphons ("heat traps"), 2-way valves (zone valves) or additional check valves.

### Example:

- The station contains two check valves (2 x 200 mm wc = **400 mm wc**).
- You use a mixture of water and 40% strength propylene glycol as **solar fluid**.
- The installation height between collector and storage tank is **10 m**.

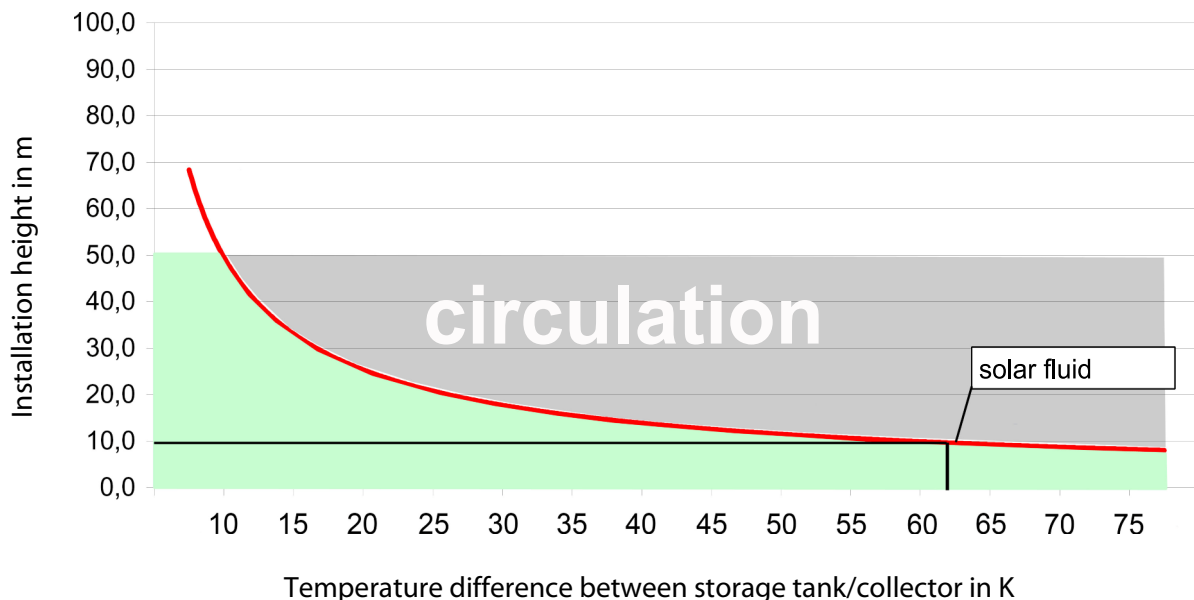

### Result:

The check valves prevent gravity circulation up to a temperature difference of **about 62 K**. If the temperature difference between the collector and the tank is larger, the difference in density of the solar fluid will be so large that the check valves are pushed open.

**Do you need to know it exactly?**

The density of the solar fluid strongly decreases with increasing temperature. In systems of high system heights and with large temperature differences, the difference in density causes gravity circulation. This circulation can result in the storage tank cooling down.

**Calculation example:  $\Delta p = \Delta \rho * g * h$** 

Collector temperature: 5 °C: Solar fluid density  $\rho_1 = 1042 \text{ kg/m}^3$

Storage tank temperature: 67 °C: Solar fluid density  $\rho_2 = 1002.5 \text{ kg/m}^3$

$$\Delta \rho = \rho_1 - \rho_2 = 39.5 \text{ kg/m}^3$$

$$g = 9.81 \text{ m/s}^2$$

Installation height  $h = 10 \text{ m}$

$$\Delta p = 3875 \text{ Pa} = 395 \text{ mm wc}$$

The two check valves of the station (2 x 200 mm wc) are sufficient for an installation height of 10 m and a temperature difference of up to 62 K between the collector and the tank.

## 9 Disposal

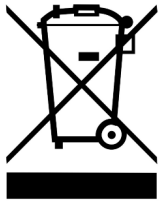
NOTICE	
	<p>Electrical and electronic devices must not be disposed of in the household waste.</p> <p>For your return, there are free collection points for electrical appliances and, if necessary, additional points of acceptance for the reuse of the devices in your area. The addresses can be obtained from your city or communal administration.</p> <p>If the old electrical or electronic device contains personal data, you are responsible for deleting it before returning the device.</p> <p>Batteries and rechargeable batteries must be removed prior to the disposal of the product. Depending on the product equipment (partly with optional accessories), single components can also contain batteries and rechargeable batteries.</p> <p>Please observe the disposal symbols on the components.</p>

### Disposal of transport and packaging materials

The packaging materials are made of recyclable materials and can be disposed of with recyclable materials.

## 10 Commissioning report

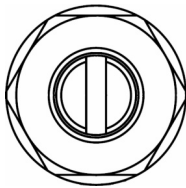
System operator			
Location of installation			
Collectors (number / type)			
Collector surface	m <sup>2</sup>		
System height	m (height difference between the station and the collector field)		
Pipeline	Diameter =	mm;	length = m
Venting (collector field)	<input type="checkbox"/> manual vent valve	<input type="checkbox"/> automatic vent valve	
	<input type="checkbox"/> no	<input type="checkbox"/> vented	
Bleeding device (station)	<input type="checkbox"/> vented		
Solar fluid (type)	% glycol		
Antifreeze (checked up to):	°C	<b>Serial numbers</b>	
Flow rate	l/m	<ul style="list-style-type: none"> <li>• Station</li> </ul>	
Pump (type)			
Pump speed level (I, II, III)		<ul style="list-style-type: none"> <li>• Controller</li> </ul>	
System pressure	mbars	<ul style="list-style-type: none"> <li>• Software version</li> </ul>	
Expansion tank (type)			
Initial pressure	mbars	Restrictor position:	
Safety valve	<input type="checkbox"/> checked		
Check valves	<input type="checkbox"/> checked		
Installation company		Date, signature	

Item no. 9976x0210x-mub-en

Translation of the original instructions

We reserve the right to make technical changes without notice!

Printed in Germany – Copyright by PAW GmbH & Co. KG

PAW GmbH & Co. KG

Böcklerstr. 11

31789 Hameln, Germany

[www.paw.eu](http://www.paw.eu)

Phone: +49-5151-9856-0

Fax: +49-5151-9856-98