



Montage- und Bedienungsanleitung Rücklaufhochhaltung mit Stellmotor



Installation and Operation Instructions Return flow temperature maintenance with actuator



Notice de montage et d'utilisation Maintien de la température de retour avec servomoteur



Istruzioni per il montaggio e per l'uso Innalzamento della temperatura di ritorno con servomotore

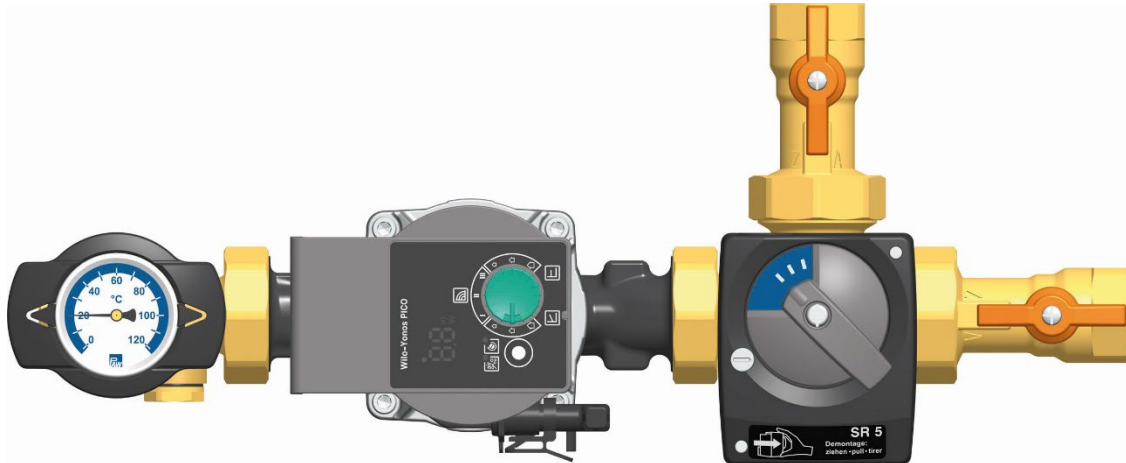

Inhaltsverzeichnis

1	Allgemeines.....	3
1.1	Geltungsbereich der Anleitung.....	3
1.2	Bestimmungsgemäße Verwendung.....	3
2	Sicherheitshinweise.....	4
3	Produktbeschreibung.....	5
3.1	Ausstattung.....	5
3.2	Funktion.....	6
4	Montage und Installation [Fachmann].....	7
4.1	Montage des Stellmotors [Fachmann].....	7
5	Lieferumfang [Fachmann].....	10
5.1	Ersatzteile DN 20.....	11
5.2	Ersatzteile DN 25.....	12
5.3	Ersatzteile DN 32.....	13
5.4	Ersatzteile DN 40.....	14
5.5	Ersatzteile DN 50.....	15
6	Technische Daten.....	16
6.1	Druckverlust- und Pumpenkennlinien.....	17
7	Entsorgung.....	19

1 Allgemeines



Lesen Sie diese Anleitung vor der Installation und Inbetriebnahme sorgfältig durch.
Bewahren Sie diese Anleitung zum späteren Gebrauch in der Nähe der Anlage auf.

1.1 Geltungsbereich der Anleitung

Diese Anleitung beschreibt die Funktion, Installation, Inbetriebnahme und Bedienung der Rücklaufhochhaltung mit Stellmotor in DN 20 - DN 50.

Für andere Komponenten der Anlage, wie z. B. die Pumpe, den Regler oder den Stellmotor, beachten Sie bitte die Anleitungen des jeweiligen Herstellers. Die mit [Fachmann] bezeichneten Kapitel richten sich ausschließlich an den Fachhandwerker.

1.2 Bestimmungsgemäße Verwendung

Das Produkt darf nur in Heizungskreisen unter Berücksichtigung der in dieser Anleitung angegebenen technischen Grenzwerte verwendet werden.

Es darf **nicht** in Trinkwasseranwendungen eingesetzt werden.

Die bestimmungswidrige Verwendung führt zum Ausschluss jeglicher Haftungsansprüche.

Das Produkt entspricht den relevanten Richtlinien und ist daher mit dem CE-Kennzeichen versehen.

Die Konformitätserklärung kann beim Hersteller angefordert werden.



Verwenden Sie ausschließlich PAW-Zubehör in Verbindung mit dem Produkt.

2 Sicherheitshinweise

Die Installation und Inbetriebnahme sowie der Anschluss der elektrischen Komponenten setzen Fachkenntnisse voraus, die einem anerkannten Berufsabschluss als Anlagenmechaniker/in für Sanitär-, Heizungs- und Klimatechnik bzw. einem Beruf mit vergleichbarem Kenntnisstand entsprechen [Fachmann].

Bei der Installation und Inbetriebnahme muss Folgendes beachtet werden:

- Einschlägige regionale und überregionale Vorschriften
- Unfallverhütungsvorschriften der Berufsgenossenschaft
- Anweisungen und Sicherheitshinweise dieser Anleitung

 VORSICHT	
	<p>Personen- und Sachschaden!</p> <p>Das Produkt ist nur geeignet für den Einsatz in Heizungskreisen mit Heizungswasser gemäß VDI 2035 / Ö-Norm H 5195-1.</p> <ul style="list-style-type: none"> ▶ Das Produkt darf nicht in Trinkwasseranwendungen eingesetzt werden.

HINWEIS
<p>Sachschaden durch Mineralöle!</p> <p>Mineralölprodukte beschädigen die EPDM-Dichtungselemente nachhaltig, wodurch die Dichteigenschaften verloren gehen. Für Schäden, die durch derartig beschädigte Dichtungen entstehen, übernehmen wir weder eine Haftung noch leisten wir Garantieersatz.</p> <ul style="list-style-type: none"> ▶ Vermeiden Sie unbedingt, dass EPDM mit mineralölhaltigen Substanzen in Kontakt kommt. ▶ Verwenden Sie ein mineralölfreies Schmiermittel auf Silikon- oder Polyalkylenbasis, wie z. B. Unisilikon L250L und Syntheso Glep 1 der Firma Klüber oder Silikonspray.

3 Produktbeschreibung

3 Produktbeschreibung

Die Rücklaufhochhaltungen sind vormontierte Armaturengruppen für Heizungskreise. Die Pumpe kann durch die Kugelhähne abgesperrt werden und kann so einfach gewartet werden, ohne dass das Wasser aus dem Heizungskreis abgelassen werden muss.

3.1 Ausstattung

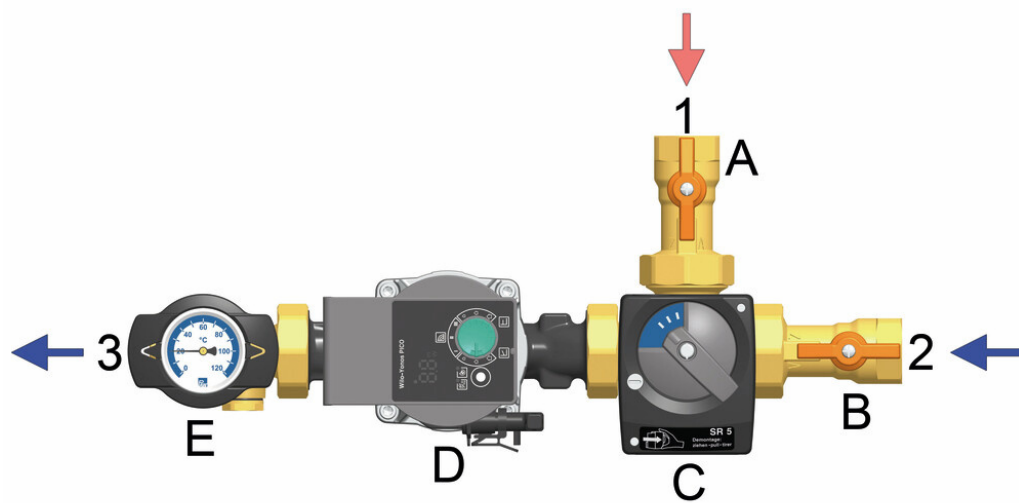

DN 25 - 50

- 1 Bypass vom Kesselvorlauf
- 2 Rücklauf vom Pufferspeicher
- 3 Rücklauf zum Kessel
- A Kugelhahn Bypass vom Kesselvorlauf
- B Kugelhahn Rücklauf vom Pufferspeicher
- C 3-Wege-Ventil mit Stellmotor
- D Heizungspumpe
- E Kugelhahn Rücklauf
- F* Rücklaufhochhaltung DN 25 und DN 32, mit optionaler Isolierung (abhängig von Pumpenversion)



3.2 Funktion

Mit Hilfe der Rücklaufhochhaltung wird eine Unterschreitung des Taupunktes im Kessel und damit die Kesselversottung verhindert.

Die Rücklaufhochhaltung wird zwischen dem Pufferspeicher und dem Kessel montiert. Der Stellmotor wird von einem externen Regler angesteuert. Der Stellmotor öffnet das 3-Wege-Ventil erst, wenn der Kesselkreis die eingestellte Öffnungstemperatur erreicht hat. Dann steht die Leistung der Pumpe zur Beladung des Speichers zur Verfügung.

Einsatzgebiete:

- für Wärmequellen, bei denen eine Rücklaufhochhaltung nötig ist, wie z.B. Festbrennstoffkessel, Holzfeuerungsanlagen und Kamine

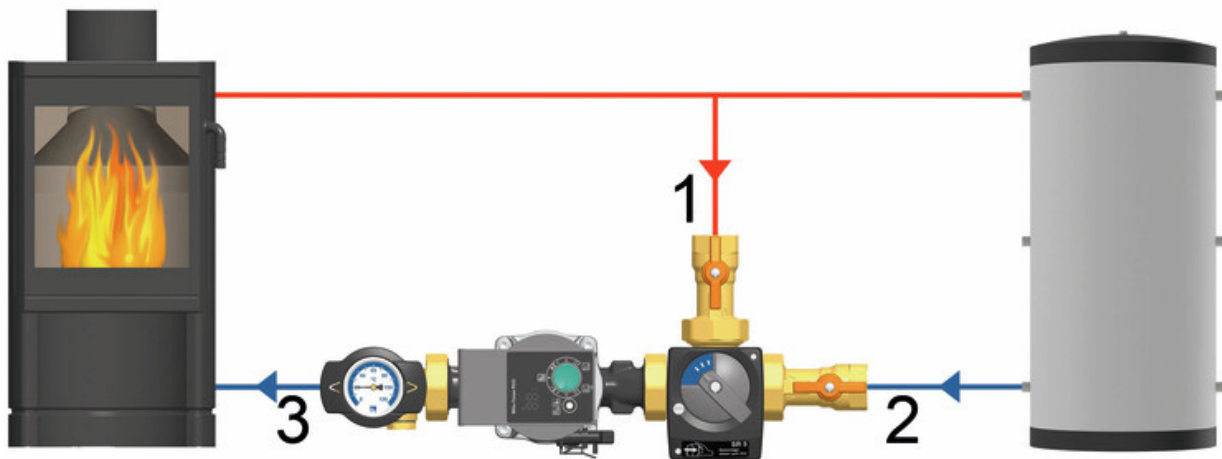

4 Montage und Installation [Fachmann]

HINWEIS

Sachschaden!

Um Schäden an der Anlage zu verhindern, muss der Montageort trocken, tragsicher, frostfrei und vor UV-Strahlung geschützt sein. Montieren Sie die Pumpe immer in den Rücklauf zum Kessel, da sie durch die hohen Vorlauftemperaturen beschädigt werden könnte.

4.1 Montage des Stellmotors [Fachmann]

Stellmotor SR2 / SR5 / SR10

Stellmotor SR2

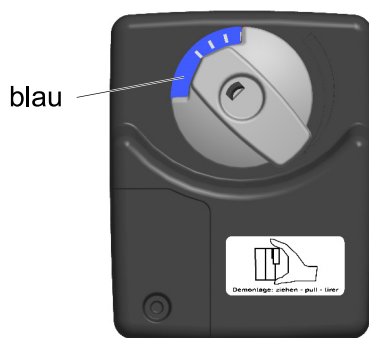

Stellmotor SR5 / SR10

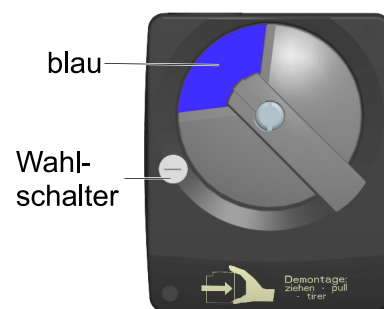

1. Stellen Sie den Stellmotor auf Handbetrieb.

SR2: Drücken Sie dazu den Stellknopf ein und halten ihn gedrückt.

SR5 / SR10: Drehen Sie den Wahlschalter mit einem Schraubendreher um 90°.

2. Drehen Sie den Stellknopf nach links in die Position "blau".

3. Drehen Sie den Drehknopf des 3-Wege-Ventils so, dass die Nase nach unten bzw. nach links auf \longleftrightarrow zeigt.

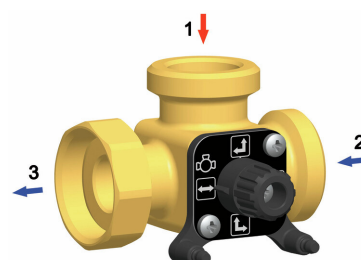
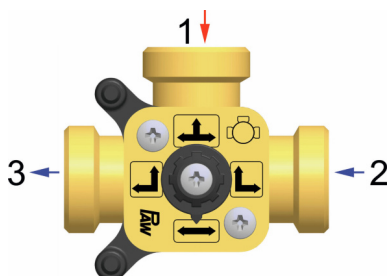



4. Drehen Sie den Stellmotor wie abgebildet und rasten Sie ihn auf das 3-Wege-Ventil.
5. Schließen Sie den Stellmotor an den Regler an.
6. SR2: Der Stellmotor kehrt selbstständig in den Automatikbetrieb zurück.

SR5 / SR10: Drehen Sie den Wahlschalter am Stellmotor mit einem Schraubendreher um 90°. Der Stellmotor befindet sich jetzt im Automatikbetrieb.

Der Stellmotor ist jetzt betriebsbereit.

Wenn der Motor aktiviert wird, dreht er 90° im Uhrzeigersinn!

Stellmotor SR2 - DN 20

100 % Rücklauf



Position "blau"

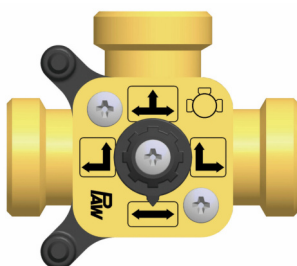

Nase zeigt auf ↔

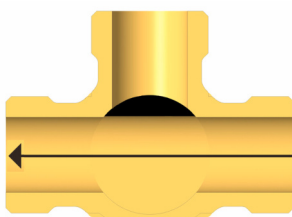

100 % aus dem Kesselvorlauf



Position "rot"

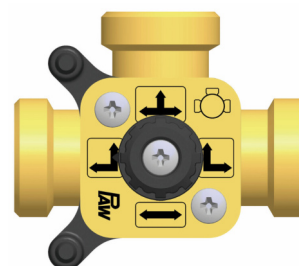

Nase zeigt auf ↗

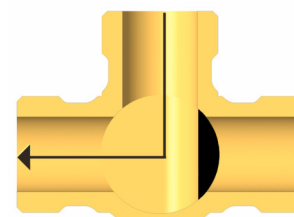

Stellmotor SR5 - DN 25 + DN 32 + DN 40 / SR10 - DN 40 + DN 50

100 % Rücklauf



Position "blau"

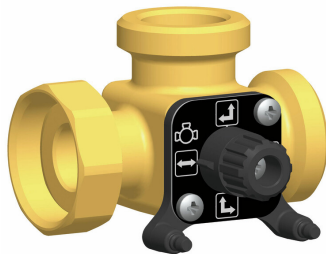

Nase zeigt auf ↔

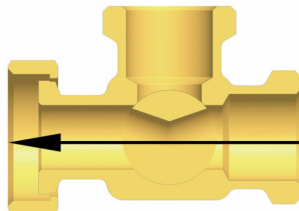

100 % aus dem Kesselvorlauf



Position "rot"



Nase zeigt auf ↗

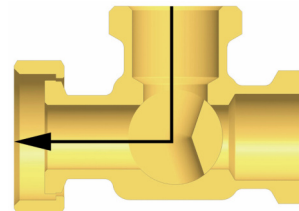

5 Lieferumfang [Fachmann]

HINWEIS

Seriennummer

Reklamationen und Ersatzteilanfragen/-bestellungen werden ausschließlich unter Angabe der Seriennummer bearbeitet! Die Seriennummer befindet sich auf dem Rücklaufrohr des Produktes.

5 Lieferumfang [Fachmann]

5.1 Ersatzteile DN 20

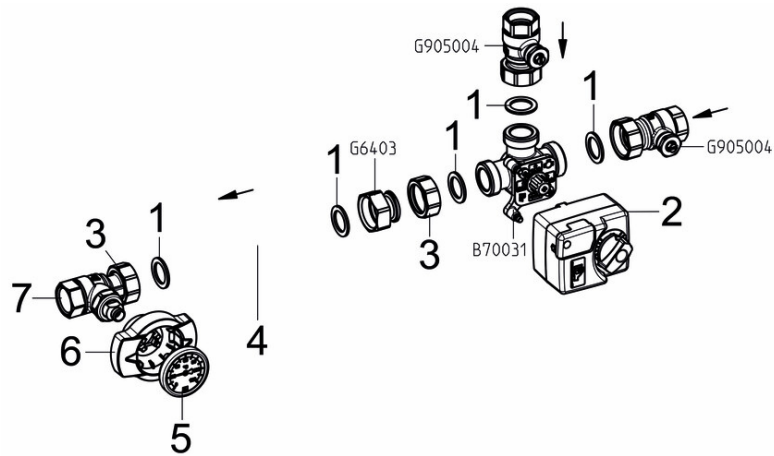

Position	Ersatzteil	Artikelnummer
1	Dichtung, ½", für Verschraubung 1"	N00024
2	Stellmotor SR2, 230 V AC, 2 Nm, 105 s / 90°	N00070
3	Überwurfmutter G 1"	N00302
4	Pumpe siehe folgende Tabelle	
5	Zeigerthermometer, blaue Skala, d = 50 mm, 0 - 120 °C	N00243
6	Thermometergriff, für Thermokugelhahn 1"	N00248
7	Thermokugelhahn DN 20, F ½" x ¾" IG	N00202

Artikelnr. Rücklaufhochhaltung	Pumpe	Artikelnr. Pumpe	EEI
96083WP6	Wilo Para SC 15/6-43	N00258	< 0,20
96083WN06	Wilo Yonos PICO 15/1-6	N00315	< 0,20
96083GM6	Grundfos UPM3 Auto L 15-70	N00333	< 0,20
96083GH6	Grundfos Alpha2.1 15-60	N00336	< 0,17

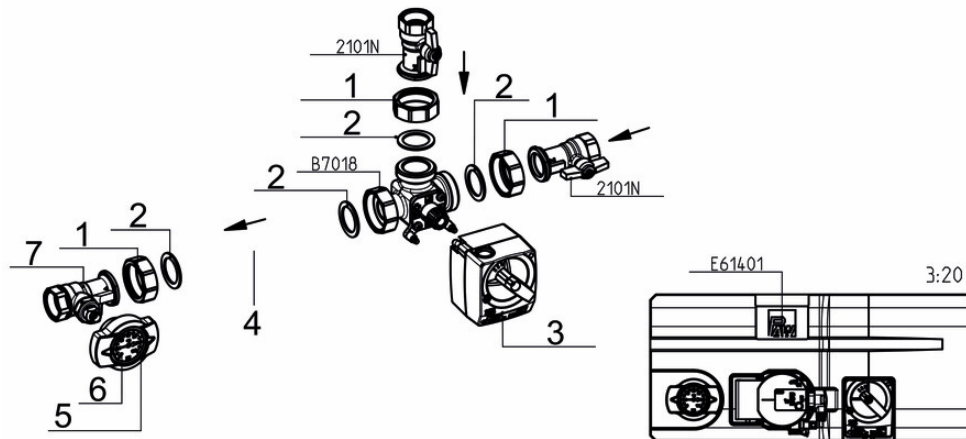
5.2 Ersatzteile DN 25

Position	Ersatzteil	Artikelnummer
1	Überwurfmutter G 1½"	N00269
2	Dichtung 1", für Verschraubung 1½"	N00036
3	Stellmotor 5 Nm, 230 V, 50 Hz	705001
4	Pumpe siehe folgende Tabelle	
5	Thermometergriff für Thermokugelhahn 1"	N00248
6	Zeigerthermometer, blaue Skala, d=50 mm, 0-120 °C	N00243
7	Thermokugelhahn TK DN 25, F1" x 1"IG, ½" Muffe links	N00013
o. P.	Drehknopf mit Anschlagkante	N00232

Artikelnr. Rücklaufhochhaltung	Pumpe	Artikelnr. Pumpe	EEI
960841WP6	Wilo Para SC 25/6-43	N00259	< 0,20
960841WP8	Wilo Para SC 25/8-60	N00271	< 0,21
960841WN06	Wilo Yonos PICO 25/1-6	N00214	< 0,20
960841GM6	Grundfos UPM3 Auto L 25-70	N00237	< 0,20
960841GH6	Grundfos Alpha2.1 25-60	N00236	< 0,17
960841GL9	Grundfos UPML 25-105 AUTO	N00396	< 0,23

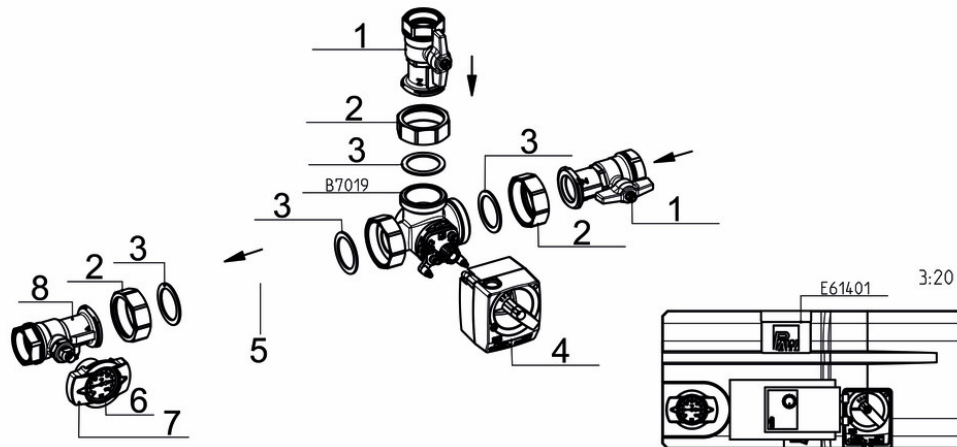
5.3 Ersatzteile DN 32

Position	Ersatzteil	Artikelnummer
1	Pumpenkugelhahn PK 1¼", F 1¼" x G 1¼"	2102
2	Überwurfmutter G 2"	N00270
3	Dichtung 1¼", für Verschraubung 2"	N00047
4	Stellmotor 5 Nm, 230 V, 50 Hz	705001
5	Pumpe siehe folgende Tabelle	
6	Zeigerthermometer, blaue Skala, d=50 mm, 0-120 °C	N00243
7	Thermometergriff für Thermokugelhahn 1"	N00248
8	Thermokugelhahn TK DN 32, F 1¼" x 1¼" IG Muffe links	N00446
o. P.	Drehknopf mit Anschlagkante	N00232

Artikelnr. Rücklaufhochhaltung	Pumpe	Artikelnr. Pumpe	EEI
960851WN06	Wilo Yonos PICO 30/1-6	N00313	< 0,20
960851WP6	Wilo Para SC 30/6-43	N00261	< 0,20
960851WY10	Wilo Yonos MAXO plus 30/0.5-10	N00398	< 0,20
960851GM6	Grundfos UPM3 Auto L 32-70	N00240	< 0,20
960851GH6	Grundfos Alpha2.1 32-60	N00239	< 0,17
960851GH12	Grundfos Magna3 32-120	N00540	0,19
960851GL9	Grundfos UPML 32-105 AUTO	N00344	≤ 0,23

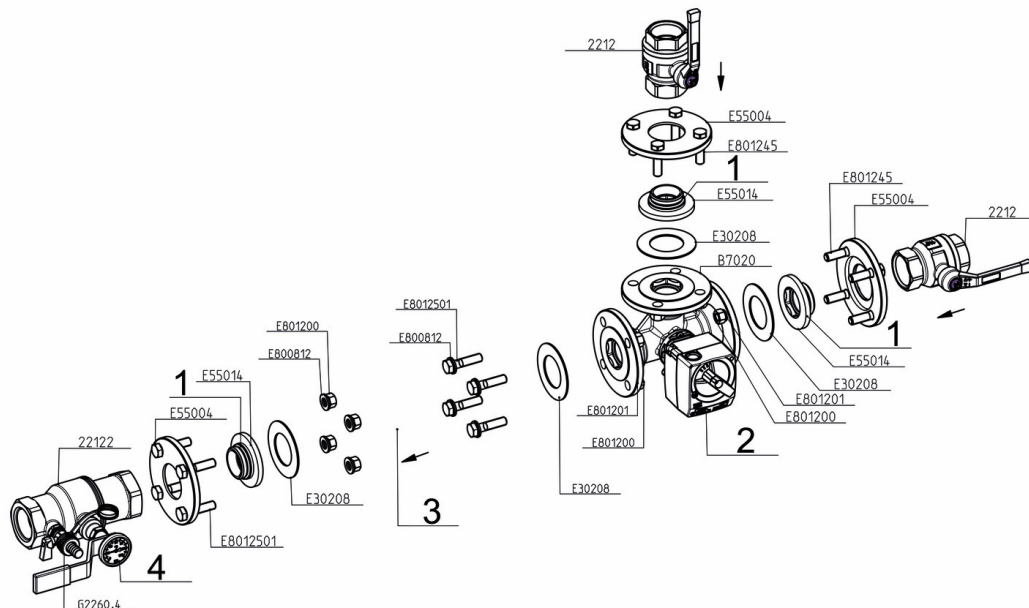
5.4 Ersatzteile DN 40

Position	Ersatzteil	Artikelnummer
1	Dichtungssatz Verteiler DN 40 / DN 50	N00061
2	Stellmotor 5 Nm, 230 V, 50 Hz	705001
3	Pumpe siehe folgende Tabelle	
4	Zeigerthermometer, blaue Skala, d=50 mm, 0 - 120 °C	N00243
o. P.	Drehknopf mit Anschlagkante	N00232
o. P.	Reduzierflansche	41610

Artikelnr. Rücklaufhochhaltung	Pumpe	Artikelnr. Pumpe	EEI
960861WY12	Wilo Yonos MAXO plus 40/0.5-12	E12343712	< 0,20
960861GH12	Grundfos Magna3 40-120F	N00545	≤ 0,18
960861GL10	Grundfos Magna1 32-100	E1217310	< 0,21
960861GL12	Grundfos Magna1 40-120F	E121761	< 0,21
960861GU12	Grundfos UPMXXL 32-120	E12144812	≤ 0,23
960861GX12	Grundfos UPMXL GEO 32-125	E12143812F	0,23

5 Lieferumfang [Fachmann]

5.5 Ersatzteile DN 50

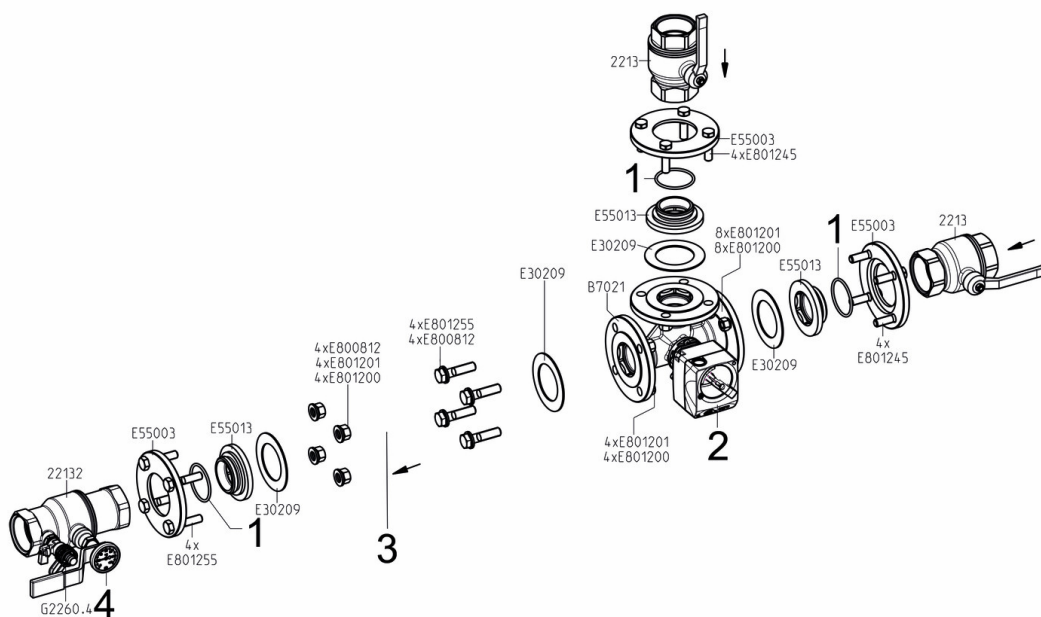

Position	Ersatzteil	Artikelnummer
1	Dichtungssatz Verteiler DN 40 / DN 50	N00061
2	Stellmotor 5 Nm, 230 V, 50 Hz	705001
3	Pumpe siehe folgende Tabelle	
4	Zeigerthermometer, blaue Skala, d=50 mm, 0 - 120 °C	N00243
o. P.	Drehknopf mit Anschlagkante	N00232
o. P.	Reduzierflansche	5162

Artikelnr. Rücklaufhochhaltung	Pumpe	Artikelnr. Pumpe	EEl
960871WY9	Wilо Yonos MAXO plus 50/0.5-9	E12343809	< 0,21
960871GL10	Grundfos Magna1 32-100	E1217310	< 0,21
960871GL12	Grundfos Magna1 50-120F	E121781	< 0,21

6 Technische Daten

Rücklaufhochhaltung	DN 20	DN 25	DN 32	DN 40	DN 50
Abmessungen					
Einbauhöhe	134 mm	187 mm	217 mm	266 mm	296 mm
Einbaulänge	359 mm	437 mm	497 mm	735 mm	792 mm
Anschlüsse	¾" IG	1" IG	1¼" IG	1½" IG	2" IG
Hydraulik					
Max. Druck	6 bar	6 bar	6 bar	6 bar	6 bar
Max. Temperatur	110 °C	110 °C	110 °C	110 °C	110 °C
K _{VS} -Wert [m ³ /h]	5,45	10	16	23	25
Leistung	bis 19,5 kW	bis 31 kW	bis 50 kW	bis 80 kW	bis 120 kW
bei ΔT = 10 K	1.650 l/h*	2.670 l/h*	4.310 l/h*	6.890 l/h*	10.340 l/h*
*Pumpen-Förderhöhe bzw. Restförderhöhe beachten!					
Werkstoffe					
Armaturen	Messing				
Dichtungen	AFM 34 / EPDM				

6.1 Druckverlust- und Pumpenkennlinien

DN 20

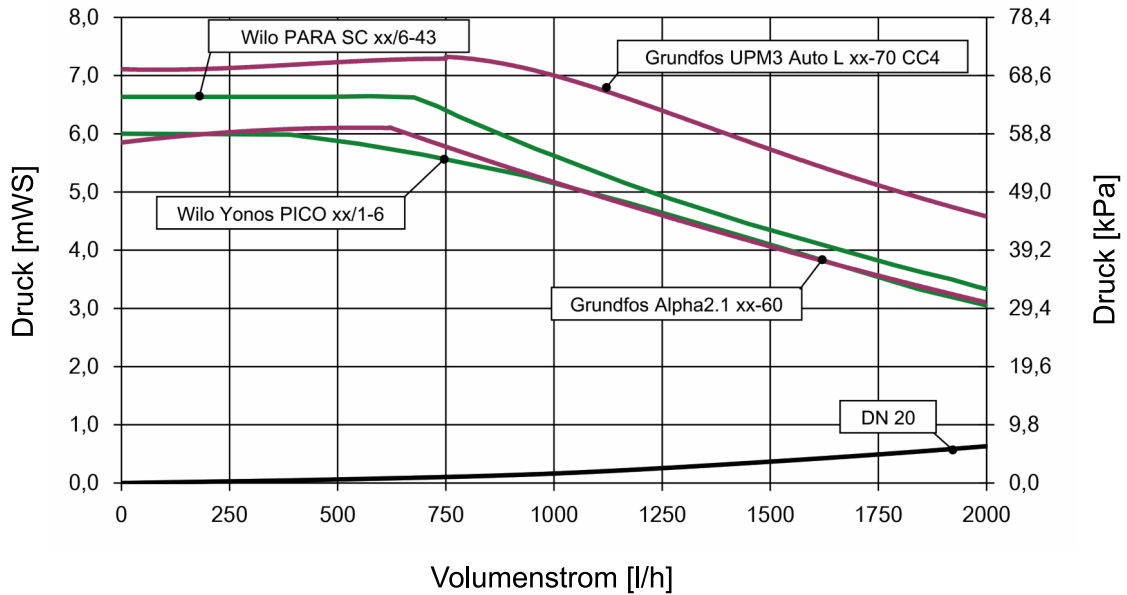

DN 25 + DN 32

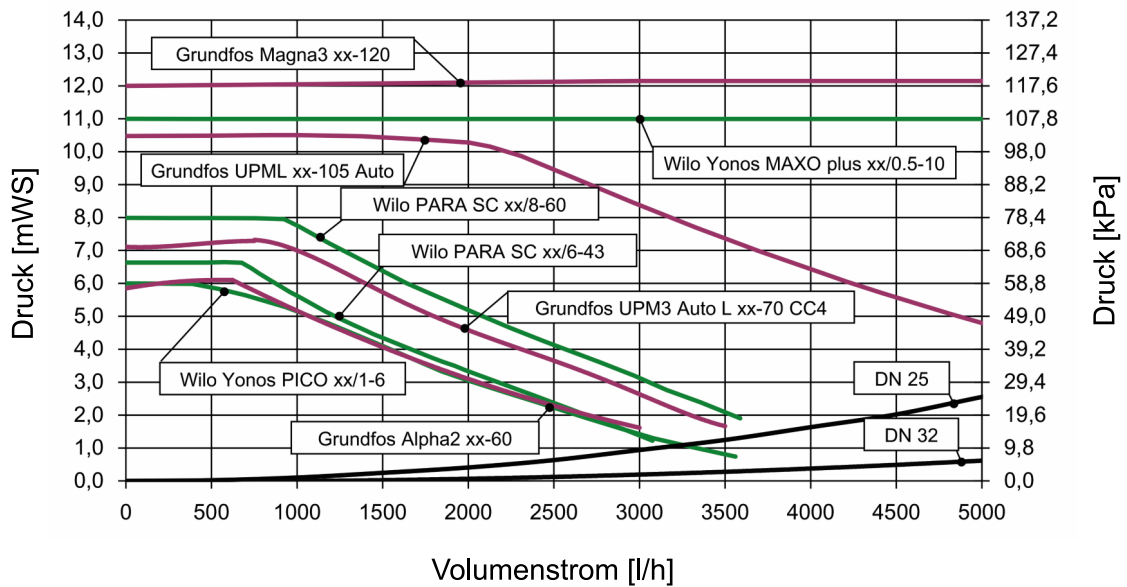

DN 40 + DN 50

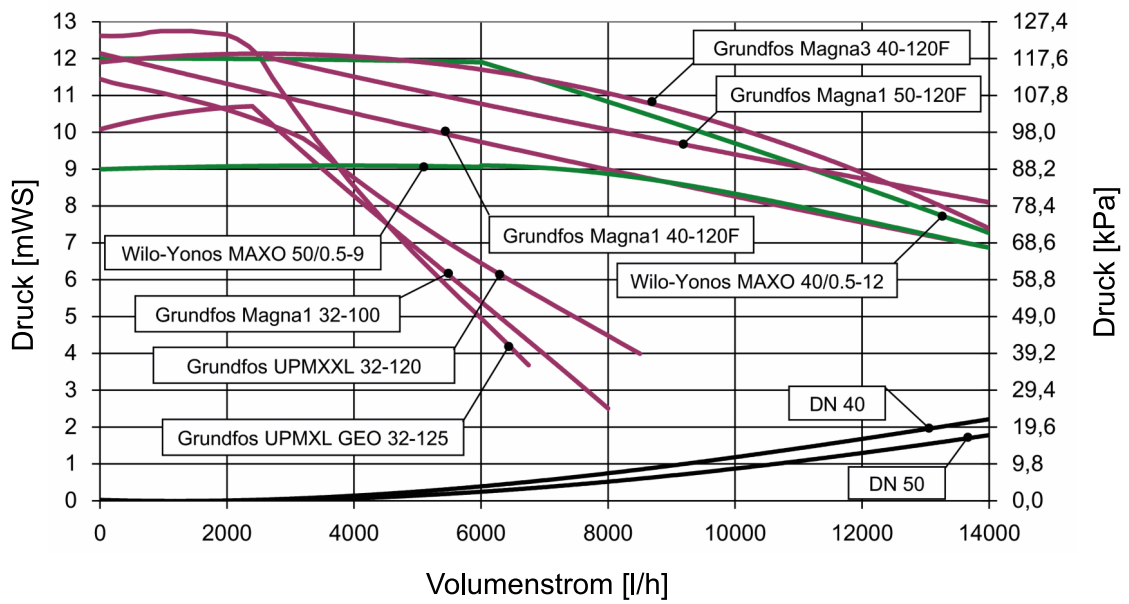

7 Entsorgung

HINWEIS

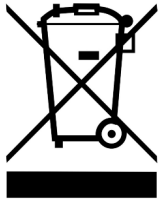

Elektro- und Elektronikgeräte dürfen nicht mit dem Hausmüll entsorgt werden.

Zur Rückgabe stehen in Ihrer Nähe kostenfreie Sammelstellen für Elektroaltgeräte sowie ggf. weitere Annahmestellen für die Wiederverwendung der Geräte zur Verfügung. Die Adressen erhalten Sie von Ihrer Stadt- bzw. Kommunalverwaltung.

Sofern das alte Elektro- bzw. Elektronikgerät personenbezogene Daten enthält, sind Sie selbst für deren Löschung verantwortlich, bevor Sie es zurückgeben.

Batterien und Akkus müssen vor der Entsorgung des Produkts ausgebaut werden.

Je nach Produktausstattung (mit zum Teil optionalem Zubehör) können einzelne Komponenten auch Batterien und Akkus enthalten. Bitte beachten Sie hierzu die auf den Komponenten angebrachten Entsorgungssymbole.

Entsorgung von Transport- und Verpackungsmaterial

Die Verpackungsmaterialien bestehen aus recycelbaren Materialien und können dem normalen Wertstoffkreislauf wieder zugeführt werden.

Art. Nr. 999608-mub-ml

Original-Anleitung

Technische Änderungen vorbehalten!

Printed in Germany - Copyright by PAW GmbH & Co. KG

PAW GmbH & Co. KG

Böcklerstraße 11

31789 Hameln, Germany

www.paw.eu

Tel: +49-5151-9856-0

Fax: +49-5151-9856-98



Installation and Operation Instructions Return flow temperature maintenance with actuator

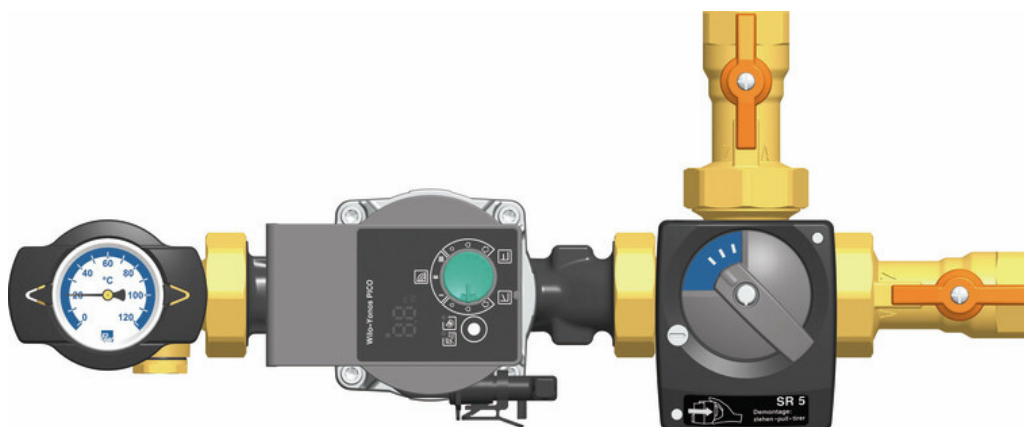

Table of Contents

1	General Information.....	3
1.1	Scope of these instructions.....	3
1.2	Designated use.....	3
2	Safety instructions.....	4
3	Product description.....	5
3.1	Equipment.....	5
3.2	Function.....	6
4	Mounting and installation [specialist].....	7
4.1	Assembly of the actuator [specialist].....	7
5	Scope of delivery [specialist].....	10
5.1	Spare parts DN 20.....	11
5.2	Spare parts DN 25.....	12
5.3	Spare parts DN 32.....	13
5.4	Spare parts DN 40.....	14
5.5	Spare parts DN 50.....	15
6	Technical data.....	16
6.1	Pressure drop and pump characteristic curves.....	17
7	Disposal.....	19

1 General Information



Carefully read these instructions before installation and commissioning.

Save these instructions in the vicinity of the installation for future reference.

1.1 Scope of these instructions

These instructions describe the installation, commissioning, function and operation of the return flow temperature maintenance with actuator in DN 20 - DN 50.

For other components of the heating system such as the pump, the controller or the actuator, please observe the instructions of the corresponding manufacturer. The chapters called [specialist] are intended for specialists only.

1.2 Designated use

The product may only be used in heating circuits taking into consideration the technical limit values indicated in these instructions.

It must **not** be used in drinking water applications.

Improper usage excludes any liability claims.

This product complies with the relevant directives and is therefore labelled with the CE mark.

The Declaration of Conformity is available upon request, please contact the manufacturer.



Only use PAW accessories with the product.

2 Safety instructions

The installation and commissioning as well as the connection of electrical components require technical knowledge commensurate with a recognised vocational qualification as a fitter for plumbing, heating and air conditioning technology, or a profession requiring a comparable level of knowledge [specialist].

The following must be observed during installation and commissioning:

- relevant local and national regulations
- accident prevention regulations of the professional association
- instructions and safety instructions mentioned in these instructions

 CAUTION	
	<p>Personal injury and damage to property!</p> <p>The product must only be used in heating circuits filled with heating water according to VDI 2035 / Ö-Norm H 5195-1.</p> <ul style="list-style-type: none"> ▶ The product must not be used in drinking water applications.

NOTICE	
<p>Material damage due to mineral oils!</p> <p>Mineral oil products cause lasting damage to seals made of EPDM, whereby the sealant properties are lost. We do not assume liability nor provide warranty for damage to property resulting from sealants damaged in this way.</p> <ul style="list-style-type: none"> ▶ It is imperative to prevent the EPDM sealing elements from making contact with substances containing mineral oils. ▶ Use a silicone- or polyalkylene-based lubricant free of mineral oil such as Unisilikon L250L and Syntheso Glep 1 from Klüber or a silicone spray. 	

3 Product description

3 Product description

The return flow temperature maintenances are preassembled fitting groups for heating circuits. The pump can be isolated by means of the ball valves and maintenance work on the pump can thus be carried out without draining the heating circuit.

3.1 Equipment

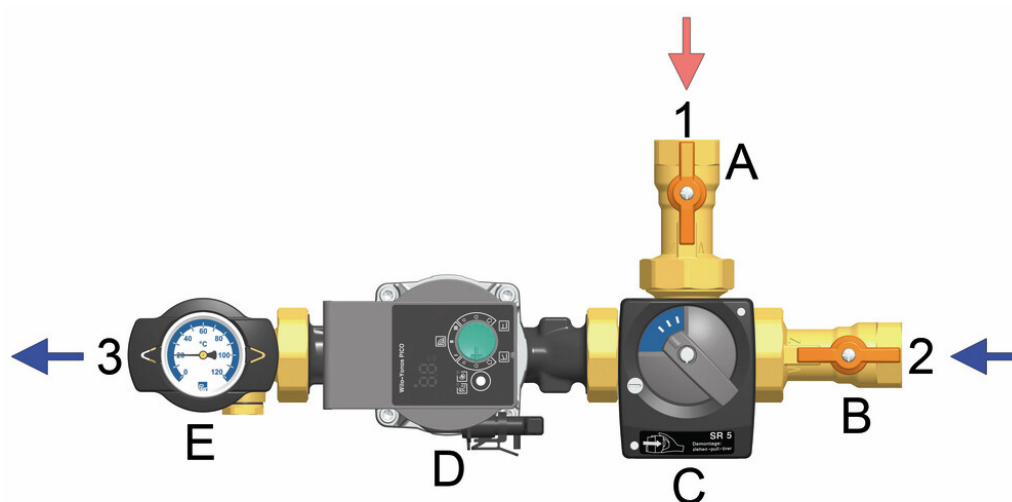

DN 25 - 50

- 1 Bypass from the boiler flow
- 2 Return from the buffer tank
- 3 Return to the boiler
- A Ball valve - bypass from the boiler flow
- B Ball valve - return from the buffer tank
- C 3-way valve with actuator
- D Heating pump
- E Ball valve - return
- F* Return flow temperature maintenance DN 25 and DN 32, with optional insulation (depending on pump version)



3.2 Function

The return flow temperature maintenance prevents the temperature in the boiler from falling under the dew point, thus reducing contamination of the boiler.

The return flow temperature maintenance is mounted between the buffer tank and the boiler.

The actuator is controlled by an external controller. The actuator opens the 3-way valve only when the boiler circuit has reached the opening temperature set. Then the pump can charge the tank.

Application ranges:

- for heat sources requiring a return flow temperature maintenance, as for example solid fuel boilers, wood firing and stove heating systems

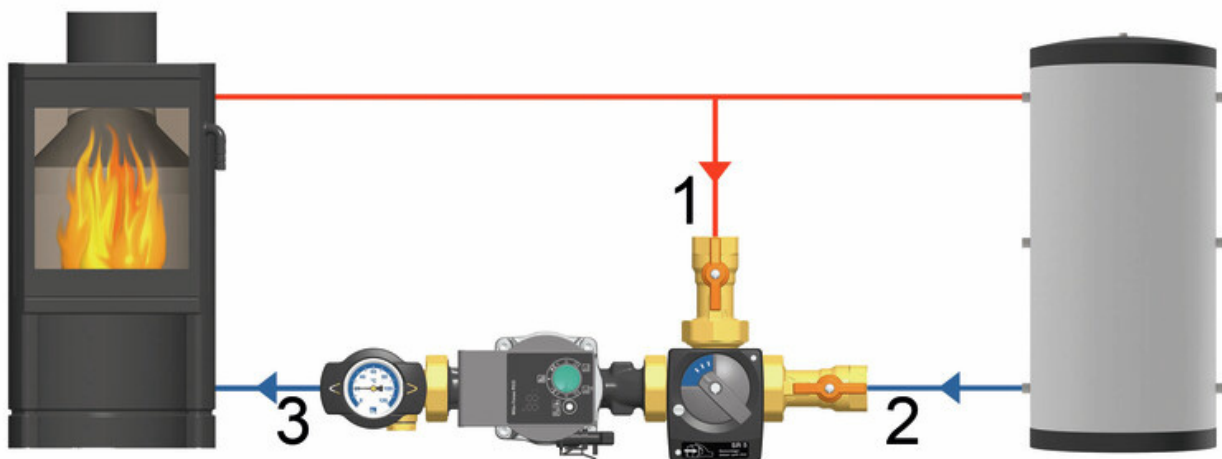

4 Mounting and installation [specialist]

NOTICE

Damage to property!

The installation site must be dry, stable, frost-proof and protected against ultraviolet radiation in order to prevent material damage of the installation. Always mount the pump into the return line to the boiler, as the high flow temperatures could damage the pump.

4.1 Assembly of the actuator [specialist]

Actuator SR2 / SR5 / SR10

Actuator SR2

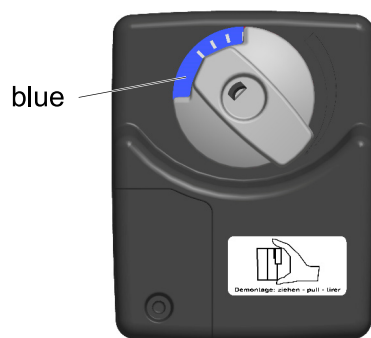

Actuator SR5 / SR10

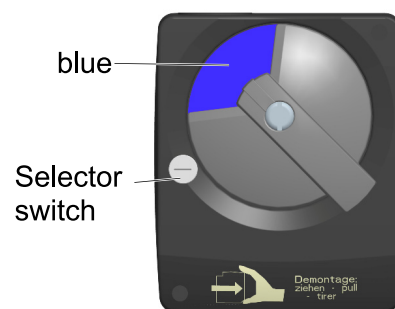

1. Set the actuator to manual mode.
 - SR2: Press the adjusting knob and keep it pressed.
 - SR5 / SR10: Turn the selector switch with a screwdriver by 90°.
2. Turn the adjusting knob to the left to position "blue".
3. Turn the rotary knob of the three-way valve so that the nose points downwards or to the left to \leftrightarrow .

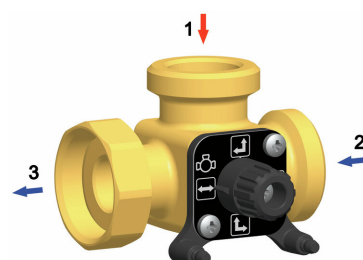
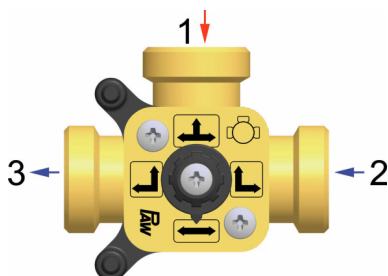



4. Turn the actuator as illustrated and mount it to the three-way valve.
5. Connect the actuator to the controller.
6. SR2: The actuator automatically returns to automatic mode.
SR5 / SR10: Turn the selector switch at the actuator with a screwdriver by 90°. The actuator is now in automatic mode.

The actuator is ready for operation.

When the actuator is activated, it turns 90° in clockwise direction!

Actuator SR2 - DN 20

100 % return



Position "blue"

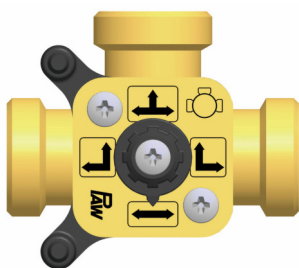

Nose points to ↔

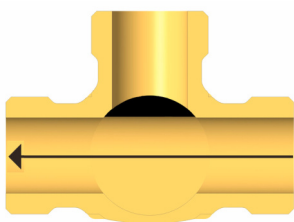

100% from the boiler flow



Position "red"

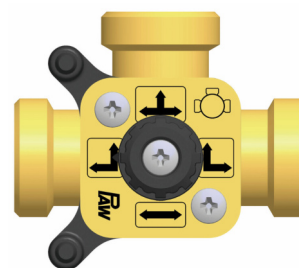

Nose points to ↶↷

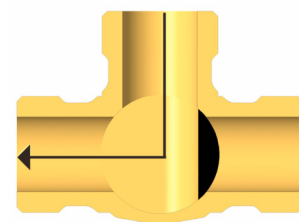

4 Mounting and installation [specialist]

Actuator SR5 - DN 25 + DN 32 + DN 40 / SR10 - DN 40 + DN 50

100 % return



Position "blue"

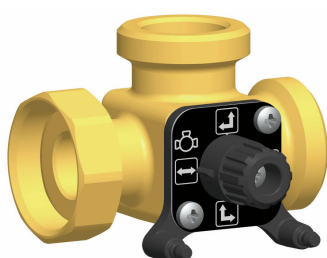

Nose points to ↔

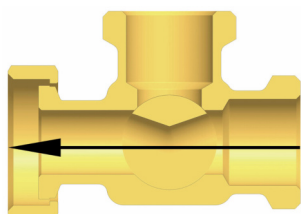

100% from the boiler flow



Position "red"

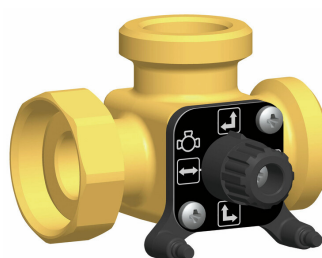

Nose points to ↗

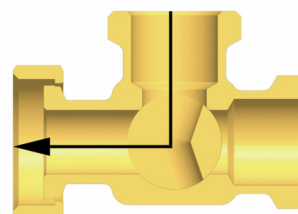



5 Scope of delivery [specialist]

NOTICE

Serial number

Complaints and requests/orders of spare parts will only be processed with information on the serial number! The serial number is placed on the return pipe of the product.

5 Scope of delivery [specialist]

5.1 Spare parts DN 20

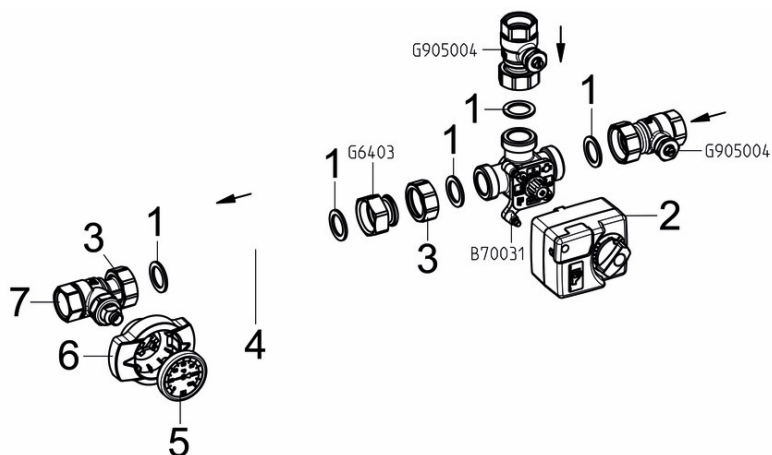

Position	Spare part	Item number
1	Gasket ½", for threaded connection 1"	N00024
2	Actuator SR2, 230 V AC, 2 Nm, 105 s / 90°	N00070
3	Union nut G 1"	N00302
4	Pump see following table	
5	Dial thermometer, blue scale, d = 50 mm, 0 - 120 °C	N00243
6	Thermometer handle for thermometer ball valve 1"	N00248
7	Thermometer ball valve DN 20, F ½" x ¾" int. thread	N00202

Item no. return flow temp. maintenance	Pump	Item no. pump	EEI
96083WP6	Wilo Para SC 15/6-43	N00258	< 0.20
96083WN06	Wilo Yonos PICO 15/1-6	N00315	< 0.20
96083GM6	Grundfos UPM3 Auto L 15-70	N00333	< 0.20
96083GH6	Grundfos Alpha2.1 15-60	N00336	< 0.17

5.2 Spare parts DN 25

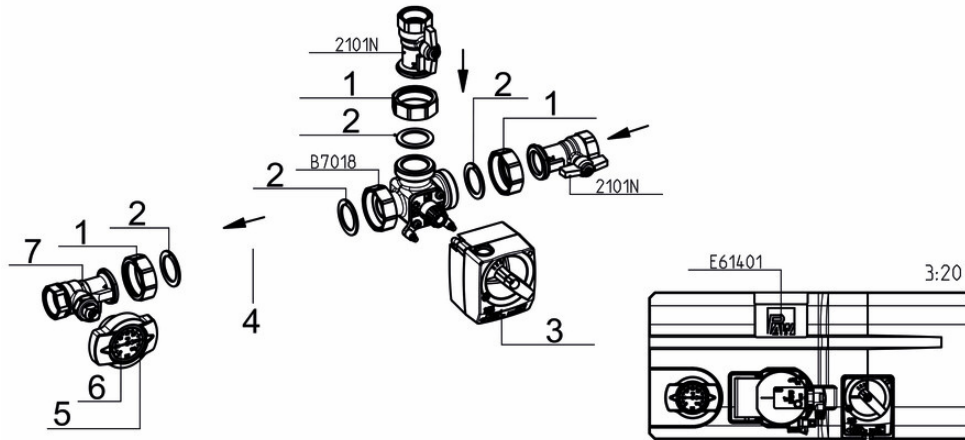

Position	Spare part	Item number
1	Union nut G 1½"	N00269
2	Gasket 1" for threaded connection 1½"	N00036
3	Actuator 5 Nm, 230 V, 50 Hz	705001
4	Pump see following table	
5	Thermometer handle for thermometer ball valve 1"	N00248
6	Dial thermometer, blue scale, d = 50 mm, 0 - 120 °C	N00243
7	Thermo ball valve TK DN 25, F1" x 1" int, ½" sleeve left	N00013
no pos.	Rotary knob with stop edge	N00232

Item no. return flow temp. maintenance	Pump	Item no. pump	EEl
960841WP6	Wilo Para SC 25/6-43	N00259	< 0.20
960841WP8	Wilo Para SC 25/8-60	N00271	< 0.21
960841WN06	Wilo Yonos PICO 25/1-6	N00214	< 0.20
960841GM6	Grundfos UPM3 Auto L 25-70	N00237	< 0.20
960841GH6	Grundfos Alpha2.1 25-60	N00236	< 0.17
960841GL9	Grundfos UPML 25-105 AUTO	N00396	< 0.23

5 Scope of delivery [specialist]

5.3 Spare parts DN 32

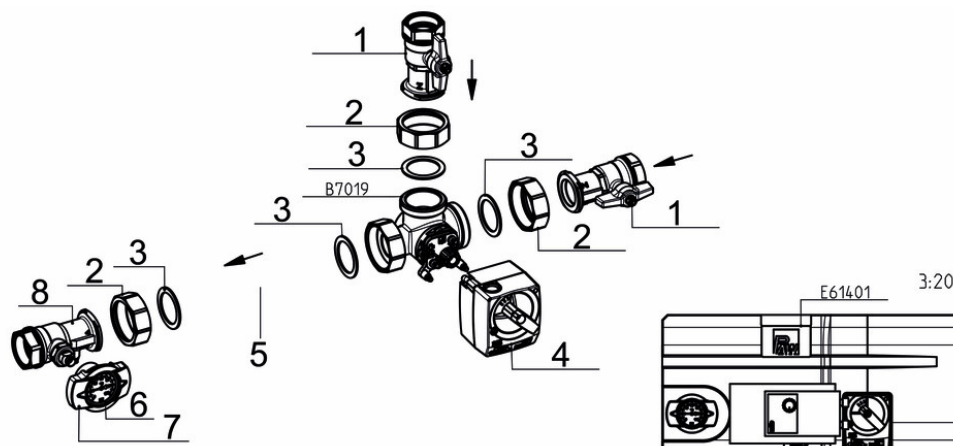

Position	Spare part	Item number
1	Pump ball valve PK 1¼", F 1¼" x int. thr. 1¼"	2102
2	Union nut G 2"	N00270
3	Gasket 1¼", for threaded connection 2"	N00047
4	Actuator 5 Nm, 230 V, 50 Hz	705001
5	Pump see following table	
6	Dial thermometer, blue scale, d = 50 mm, 0-120 °C	N00243
7	Thermometer handle for thermometer ball valve 1"	N00248
8	Thermo ball valve TK DN 32, F 1¼" x 1¼" int sleeve left	N00446
no pos.	Rotary knob with stop edge	N00232

Item no. return flow temp. maintenance	Pump	Item no. pump	EEI
960851WN06	Wilo Yonos PICO 30/1-6	N00313	< 0.20
960851WP6	Wilo Para SC 30/6-43	N00261	< 0.20
960851WY10	Wilo Yonos MAXO plus 30/0.5-10	N00398	< 0.20
960851GM6	Grundfos UPM3 Auto L 32-70	N00240	< 0.20
960851GH6	Grundfos Alpha2.1 32-60	N00239	< 0.17
960851GH12	Grundfos Magna3 32-120	N00540	0.19
960851GL9	Grundfos UPML 32-105 AUTO	N00344	< 0.24

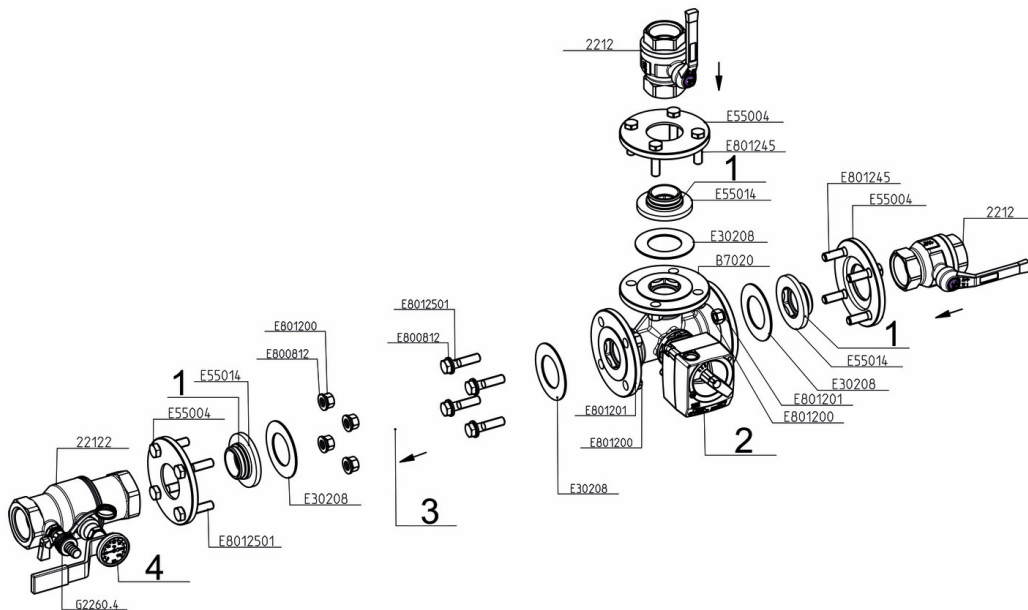
5.4 Spare parts DN 40

Position	Spare part	Item number
1	Set of gaskets dist.manif DN 40 / DN 50	N00061
2	Actuator 5 Nm, 230 V, 50 Hz	705001
3	Pump see following table	
4	Dial thermometer, blue scale, d = 50 mm, 0 - 120 °C	N00243
no pos.	Rotary knob with stop edge	N00232
no pos.	Reducer flanges	41610

Item no. return flow temp. maintenance	Pump	Item no. pump	EEI
960861WY12	Wilo Yonos MAXO plus 40/0.5-12	E12343712	< 0.20
960861GH12	Grundfos Magna3 40-120 F	N00545	< 0.19
960861GL10	Grundfos Magna1 32-100	E1217310	< 0.21
960861GL12	Grundfos Magna1 40-120 F	E121761	< 0.21
960861GU12	Grundfos UPMXXL 32-120	E12144812	< 0.24
960861GX12	Grundfos UPMXL GEP 32-125	E12143812F	0.23

5 Scope of delivery [specialist]

5.5 Spare parts DN 50

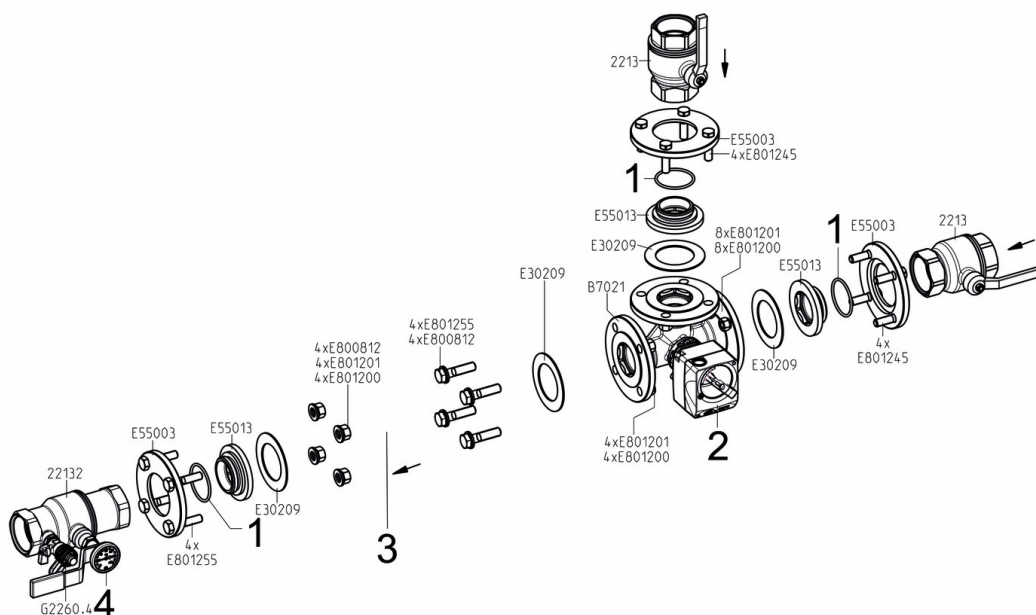

Position	Spare part	Item number
1	Set of gaskets dist.manif DN 40 / DN 50	N00061
2	Actuator 5 Nm, 230 V, 50 Hz	705001
3	Pump see following table	
4	Dial thermometer, blue scale, d = 50 mm, 0 - 120 °C	N00243
no pos.	Rotary knob with stop edge	N00232
no pos.	Reducer flanges	5162

Item no. return flow temp. maintenance	Pump	Item no. pump	EEl
960871WY9	Wilо Yonos MAXO plus 50/0.5-9	E12343809	< 0.21
960871GL10	Grundfos Magna1 32-100	E1217310	< 0.21
960871GL12	Grundfos Magna1 50-120 F	E121781	< 0.21

6 Technical data

return flow temp. maintenance	DN 20	DN 25	DN 32	DN 40	DN 50
Dimensions					
Installation height	134 mm	187 mm	217 mm	266 mm	296 mm
Installation length	359 mm	437 mm	497 mm	735 mm	792 mm
Connections	¾" int. thread	1" int. thread	1¼" int. thread	1½" int. thread	2" int. thread
Hydraulics					
Max. pressure	6 bars	6 bars	6 bars	6 bars	6 bars
Maximum temperature	110 °C	110 °C	110 °C	110 °C	110 °C
K _{VS} value [m ³ /h]	5.45	10	16	23	25
Output	up to 19.5 kW	up to 31 kW	up to 50 kW	up to 80 kW	up to 120 kW
for ΔT = 10 K	1,650 l/h*	2,670 l/h*	4,310 l/h*	6,890 l/h*	10,340 l/h*
*Observe pump head / residual head!					
Materials					
Valves and fittings	Brass				
Gaskets	AFM34 / EPDM				

6 Technical data

6.1 Pressure drop and pump characteristic curves

DN 20

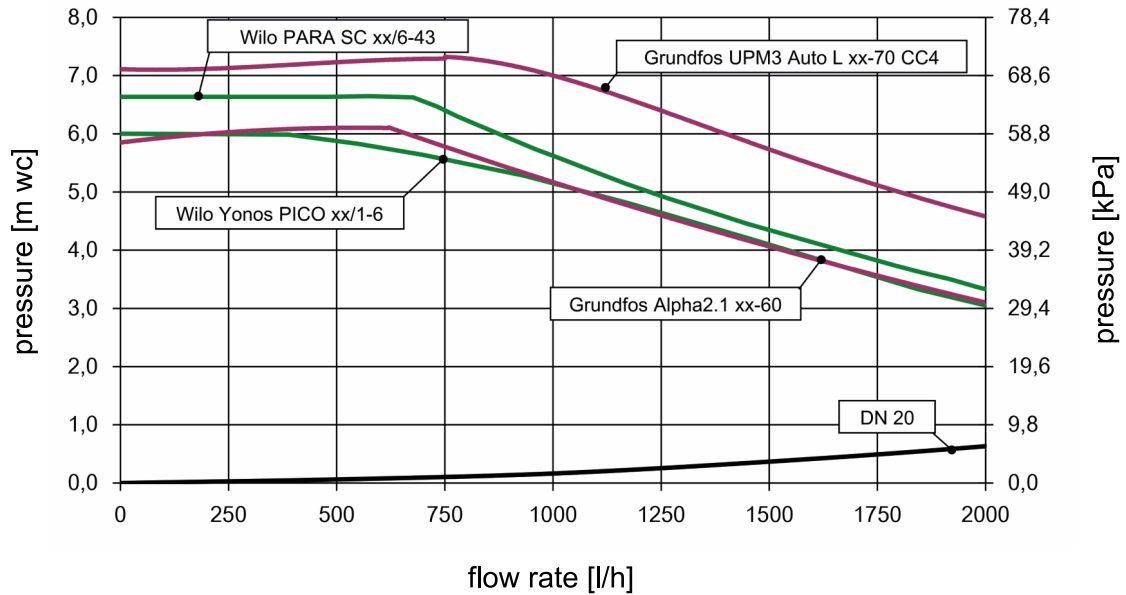

DN 25 + DN 32

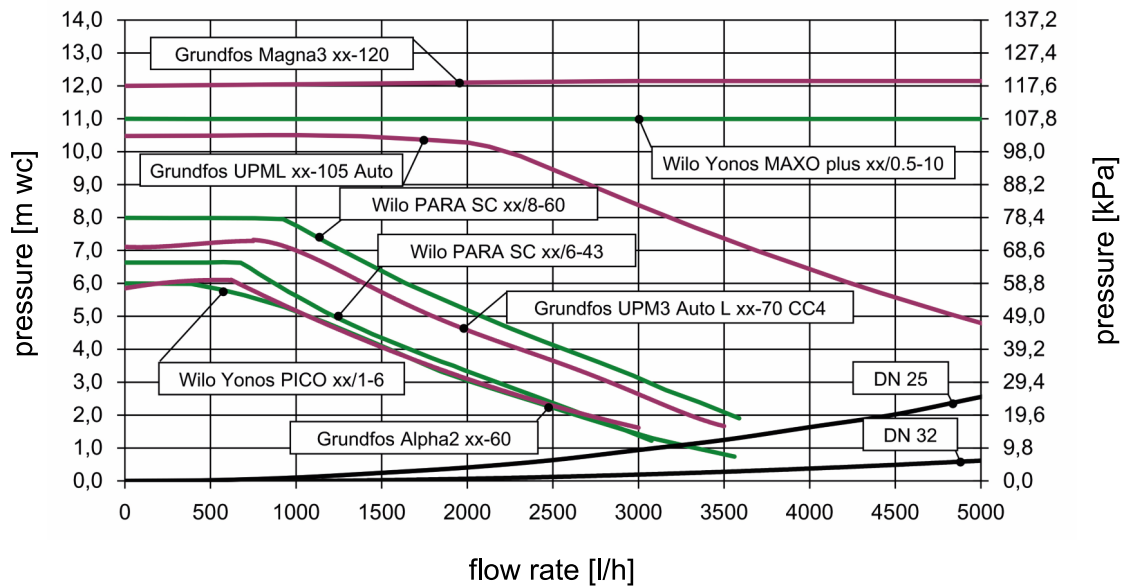

DN 40 + DN 50

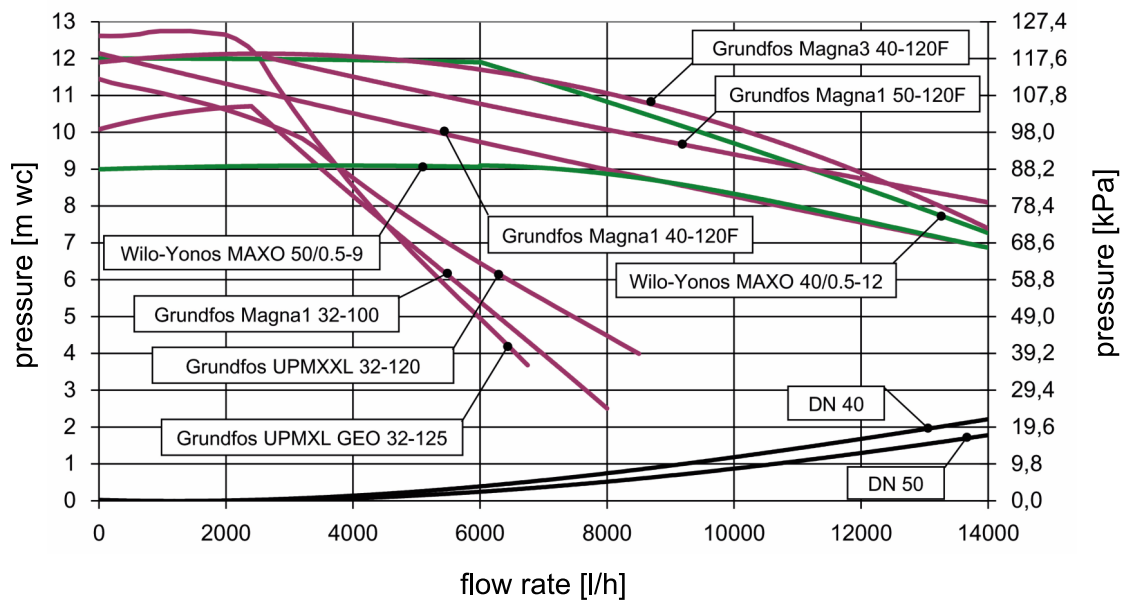

7 Disposal

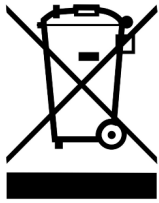
NOTICE	
	<p>Electrical and electronic devices must not be disposed of in the household waste.</p> <p>For your return, there are free collection points for electrical appliances and, if necessary, additional points of acceptance for the reuse of the devices in your area. The addresses can be obtained from your city or communal administration.</p> <p>If the old electrical or electronic device contains personal data, you are responsible for deleting it before returning the device.</p> <p>Batteries and rechargeable batteries must be removed prior to the disposal of the product. Depending on the product equipment (partly with optional accessories), single components can also contain batteries and rechargeable batteries.</p> <p>Please observe the disposal symbols on the components.</p>

Disposal of transport and packaging materials

The packaging materials are made of recyclable materials and can be disposed of with recyclable materials.

Item no. 999608-mub-ml

Translation of the original instructions

We reserve the right to make technical changes without notice!

Printed in Germany - Copyright by PAW GmbH & Co. KG

PAW GmbH & Co. KG

Böcklerstraße 11

31789 Hameln, Germany

www.paw.eu

Phone: +49-5151-9856-0

Fax: +49-5151-9856-98



Notice de montage et d'utilisation Maintenance de la température de retour avec servomoteur

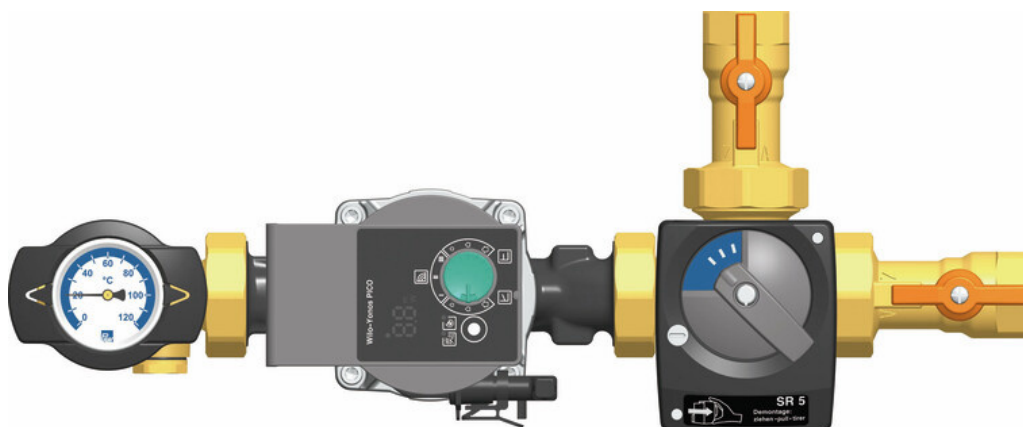

Table de matières

1	Informations générales.....	3
1.1	Champ d'application de la présente notice.....	3
1.2	Utilisation conforme à l'emploi prévu.....	3
2	Consignes de sécurité.....	4
3	Description du produit.....	5
3.1	Équipement.....	5
3.2	Fonction.....	6
4	Montage et installation [Expert].....	7
4.1	Montage du servomoteur [Expert].....	7
5	Volume de livraison [Expert].....	10
5.1	Pièces de rechange DN 20.....	11
5.2	Pièces de rechange DN 25.....	12
5.3	Pièces de rechange DN 32.....	13
5.4	Pièces de rechange DN 40.....	14
5.5	Pièces de rechange DN 50.....	15
6	Données techniques.....	16
6.1	Courbes caractéristiques de perte de charge et des pompes.....	17
7	Élimination des déchets.....	19

1 Informations générales



Veillez lire ces instructions avec attention avant de procéder à l'installation et à la mise en service. Gardez cette notice à proximité de l'installation pour vous y référer ultérieurement.

1.1 Champ d'application de la présente notice

Cette notice décrit l'installation, la mise en service, les fonctions et l'utilisation du maintien de la température retour avec servomoteur DN 20 - DN 50.

Pour les autres composants de l'installation comme la pompe, le régulateur ou le servomoteur, veuillez vous reporter aux manuels d'utilisation des fabricants respectifs. Les chapitres avec la désignation [Expert] sont destinés exclusivement au personnel qualifié.

1.2 Utilisation conforme à l'emploi prévu

Le produit doit être utilisé exclusivement dans des circuits de chauffage en prenant en considération les limites techniques indiquées dans cette notice.

Il est **interdit** d'utiliser le produit dans les applications d'eau potable.

Toute utilisation non-conforme entraînera une exclusion de garantie.

Le produit est conforme aux dispositions européennes en vigueur et porte par conséquent le marquage CE. La déclaration de conformité est disponible sur demande auprès du fabricant.

N'utilisez que des accessoires PAW avec le produit.

2 Consignes de sécurité

L'installation et la mise en service ainsi que le raccordement des composants électriques exigent des connaissances spéciales qui correspondent à une formation professionnelle reconnue de mécanicien spécialisé dans le CVC ou à une qualification comparable [Expert].

Lors de l'installation et de la mise en service, il est impératif de respecter :

- les règles régionales et nationales s'appliquant au secteur
- les directives sur la prévention des accidents de travail
- les instructions et consignes de sécurité de ce document



ATTENTION



Dommages corporels et matériels !

Le produit doit être utilisé dans des circuits de chauffage remplis par de l'eau de chauffage conforme aux normes VDI 2035 / Ö-Norm H 5195-1.

- ▶ Il est **interdit** d'utiliser le produit dans les applications d'eau potable.

AVIS

Dégâts matériels dus à des huiles minérales !

Les produits contenant de l'huile minérale endommagent considérablement les éléments d'étanchéité en EPDM qui peuvent ainsi perdre leurs propriétés d'étanchéité. Nous déclinons toute responsabilité concernant les dommages résultant de joints d'étanchéité endommagés de cette manière et nous ne garantissons pas de remplacement gratuit.

- ▶ Évitez impérativement que l'EPDM entre en contact avec des substances contenant de l'huile minérale.
- ▶ Utilisez un lubrifiant sans huiles minérales à base de silicone ou de polyalkylène, comme p. ex. Unisilikon L250L ou Syntheso Glep 1 de l'entreprise Klüber ou un spray de silicone.

3 Description du produit

3 Description du produit

Les maintiens de la température de retour sont des groupes de robinetterie prémontés pour les circuits de chauffage. La pompe intégrée peut être isolée par les vannes à sphère, ce qui permet d'effectuer des travaux d'entretien sans vidange du circuit de chauffage.

3.1 Équipement

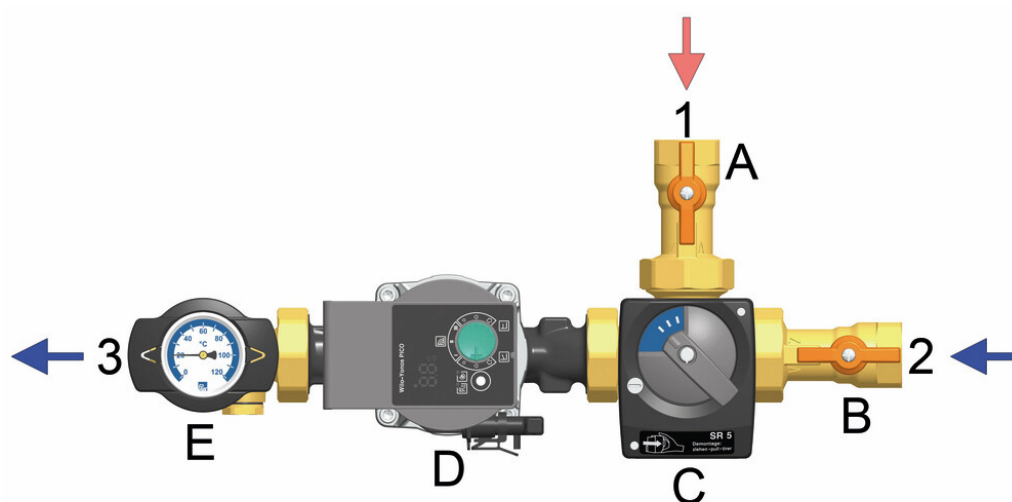

DN 25-50

- 1 Bypass du départ chaudière
- 2 Retour du ballon tampon
- 3 Retour vers la chaudière
- A Vanne à sphère, bypass du départ chaudière
- B Vanne à sphère, retour du ballon tampon
- C Vanne 3 voies avec servomoteur
- D Pompe de chauffage
- E Vanne à sphère, retour
- F* Maintien de la température de retour DN 25 et DN 32, avec isolation optionnelle (en fonction de la version de la pompe)



3.2 Fonction

Le maintien de la température de retour empêche la température de la chaudière de tomber en dessous du point de rosée, ce qui empêche un encrassement de la chaudière.

Le maintien de la température de retour est monté entre le ballon tampon et la chaudière.

Le servomoteur est commandé par un régulateur externe. Le servomoteur n'ouvre la vanne à 3 voies que lorsque le circuit chaudière a atteint la température d'ouverture réglée. La puissance de la pompe est ensuite disponible pour le chargement du ballon de stockage.

Champs d'application :

- pour les sources de chaleur nécessitant le maintien de la température retour comme par exemple les chaudières à combustibles solides, les cheminées ou poêles à bois

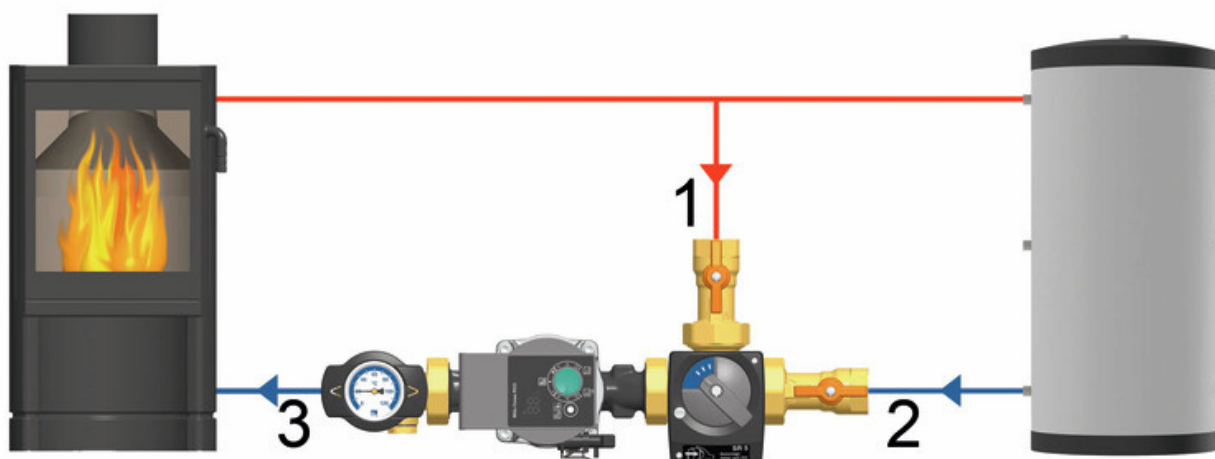

4 Montage et installation [Expert]

AVIS

Dommmages matériels !

Afin d'éviter l'endommagement de l'installation, le lieu de montage doit être sec, stable, résistant au gel et protégé contre le rayonnement UV. Montez la pompe toujours dans le retour vers la chaudière afin d'éviter un endommagement de la pompe par les températures de départ élevées.

4.1 Montage du servomoteur [Expert]

Servomoteur SR2 / SR5 / SR10

Servomoteur SR2

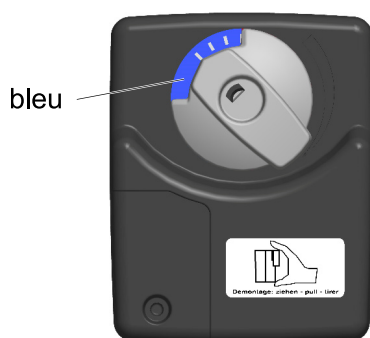

Servomoteur SR5 / SR10

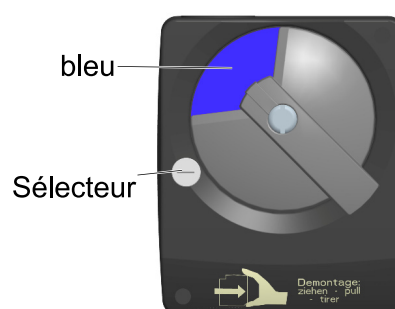

1. Mettez le servomoteur en mode manuel.

SR2: Appuyez sur le bouton de réglage et maintenez-le appuyé.

SR5 / SR10 : Tournez le sélecteur de 90° avec un tournevis.

2. Tournez le bouton de réglage vers la gauche en position "bleu".
3. Tournez le bouton rotatif de la vanne à 3 voies de sorte que le nez pointe vers le bas ou vers la gauche ↔ .

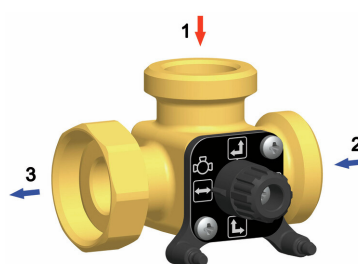
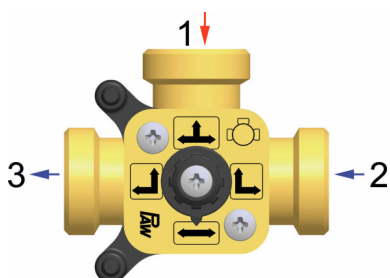



4. Tournez le servomoteur comme indiqué et l'encliquetez sur la vanne à 3 voies.
5. Raccordez le servomoteur au régulateur.
6. SR2 : Le servomoteur revient automatiquement en mode automatique.

SR5 / SR10 : Tournez le sélecteur au servomoteur de 90° avec un tournevis. Le servomoteur est maintenant en mode automatique.

Le servomoteur est maintenant opérationnel. Quand il est activé, il tourne le bouton de 90° dans le sens des aiguilles d'un montre !

Servomoteur SR2 - DN 20

100 % retour



Position "bleu"

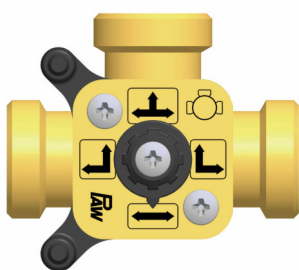

Nez orienté vers ↔

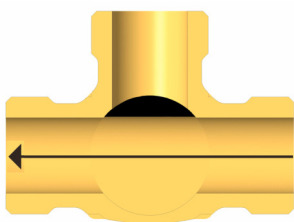

100% du départ chaudière



Position "rouge"

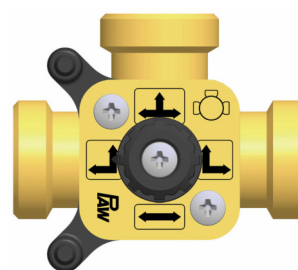

Nez orienté vers ↗

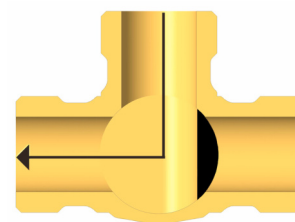

4 Montage et installation [Expert]

Servomoteur SR5 - DN 25 + DN 32 + DN 40 / SR10 - DN 40 + DN 50

100 % retour



Position "bleu"



Nez orienté vers ↔

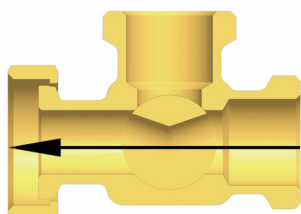

100% du départ chaudière



Position "rouge"

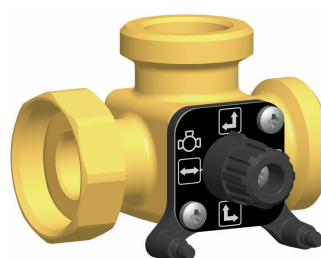

Nez orienté vers ↗

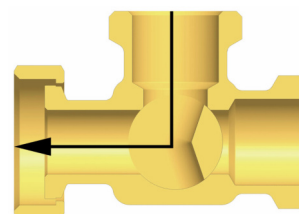

5 Volume de livraison [Expert]

AVIS

Numéro de série

Les réclamations et demandes/commandes de pièces de rechange ne sont traitées que si le numéro de série est indiqué ! Le numéro de série se trouve sur le tube de retour du produit.

5 Volume de livraison [Expert]

5.1 Pièces de rechange DN 20

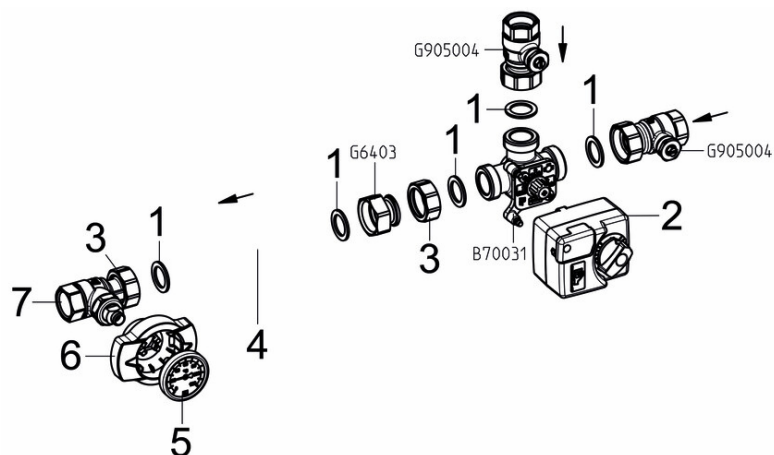

Position	Pièce de rechange	N° d'art.
1	Joint ½", pour raccord fileté 1"	N00024
2	Servomoteur SR2, 230 V AC, 2 Nm, 105 s / 90°	N00070
3	Écrou-raccord G 1"	N00302
4	Pompe : voir tableau suivant	
5	Thermomètre à cadran, échelle bleue, d = 50 mm, 0-120 °C	N00243
6	Poignée de thermomètre pour vanne à sphère thermique 1"	N00248
7	Vanne à sphère thermique DN 20, b ½" x fil. int. ¾"	N00202

N° d'art. maintien de la temp. de retour	Pompe	N° d'art. pompe	IEE
96083WP6	Wilo Para SC 15/6-43	N00258	< 0,20
96083WN06	Wilo Yonos PICO 15/1-6	N00315	< 0,20
96083GM6	Grundfos UPM3 Auto L 15-70	N00333	< 0,20
96083GH6	Grundfos Alpha2.1 15-60	N00336	< 0,17

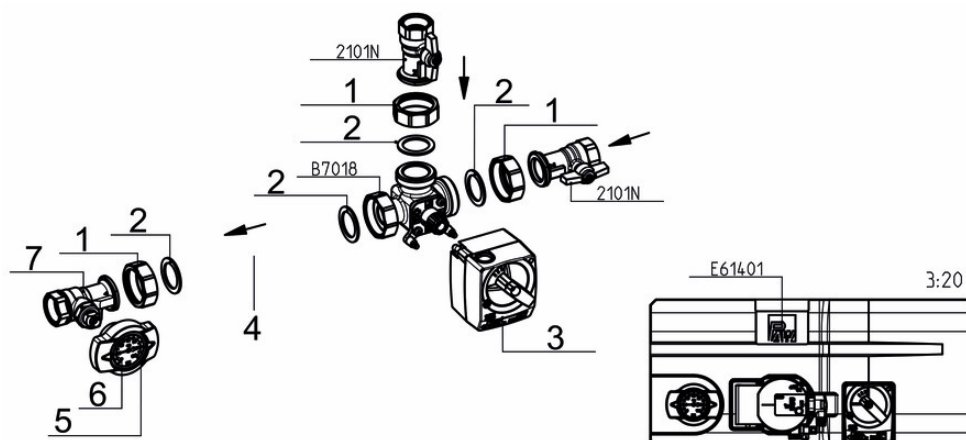
5.2 Pièces de rechange DN 25

Position	Pièce de rechange	N° d'art.
1	Écrou-raccord G1½"	N00269
2	Joint 1", pour raccord fileté 1½"	N00036
3	Servomoteur 5 Nm, 230 V, 50 Hz	705001
4	Pompe : voir tableau suivant	
5	Poignée de thermomètre pour vanne à sphère thermique 1"	N00248
6	Thermomètre à cadran, échelle bleue, d = 50 mm, 0-120 °C	N00243
7	Vanne à sphère therm. TK DN 25, b1" x int.1", ½" manchon gauche	N00013
sans pos.	Bouton rotatif ac bord d.butée	N00232

N° d'art. maintien de la temp. de retour	Pompe	N° d'art. pompe	IEE
960841WP6	Wilo Para SC 25/6-43	N00259	< 0,20
960841WP8	Wilo Para SC 25/8-60	N00271	< 0,21
960841WN06	Wilo Yonos PICO 25/1-6	N00214	< 0,20
960841GM6	Grundfos UPM3 Auto L 25-70	N00237	< 0,20
960841GH6	Grundfos Alpha2.1 25-60	N00236	< 0,17
960841GL9	Grundfos UPML 25-105 AUTO	N00396	< 0,23

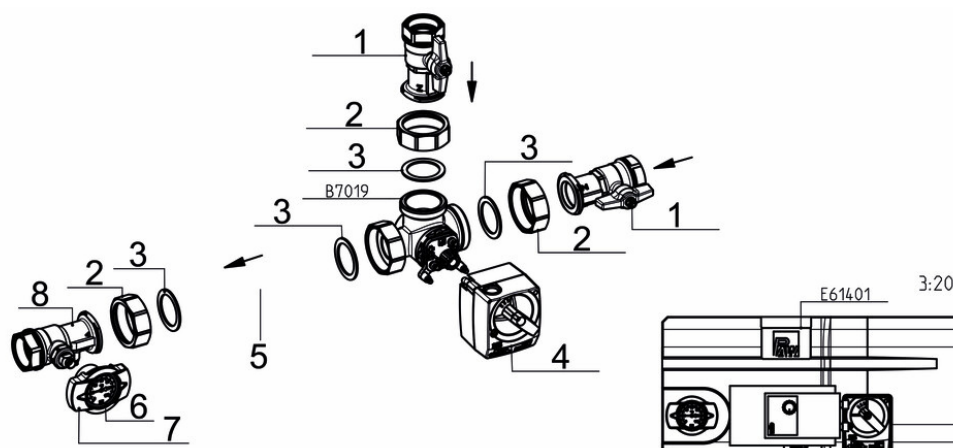
5.3 Pièces de rechange DN 32

Position	Pièce de rechange	N° d'art.
1	Vanne à sphère pr pompes PK 1¼", B 1¼" x fil. int. 1¼"	2102
2	Écrou-raccord G 2"	N00270
3	Joint 1¼", pour raccord fileté 2"	N00047
4	Servomoteur 5 Nm, 230 V, 50 Hz	705001
5	Pompe : voir tableau suivant	
6	Thermomètre à cadran, échelle bleue, d = 50 mm, 0-120 °C	N00243
7	Poignée de thermomètre pour vanne à sphère thermique 1"	N00248
8	Vanne à sphère therm. TK DN 32, b1¼" x int.1¼" manchon gauche	N00446
sans pos.	Bouton rotatif ac bord d.butée	N00232

N° d'art. maintien de la temp. de retour	Pompe	N° d'art. pompe	IEE
960851WN06	Wilo Yonos PICO 30/1-6	N00313	< 0,20
960851WP6	Wilo Para SC 30/6-43	N00261	< 0,20
960851WY10	Wilo Yonos MAXO plus 30/0.5-10	N00398	< 0,20
960851GM6	Grundfos UPM3 Auto L 32-70	N00240	< 0,20
960851GH6	Grundfos Alpha2.1 32-60	N00239	< 0,17
960851GH12	Grundfos Magna3 32-120	N00540	0,19
960851GL9	Grundfos UPML 32-105 AUTO	N00344	< 0,24

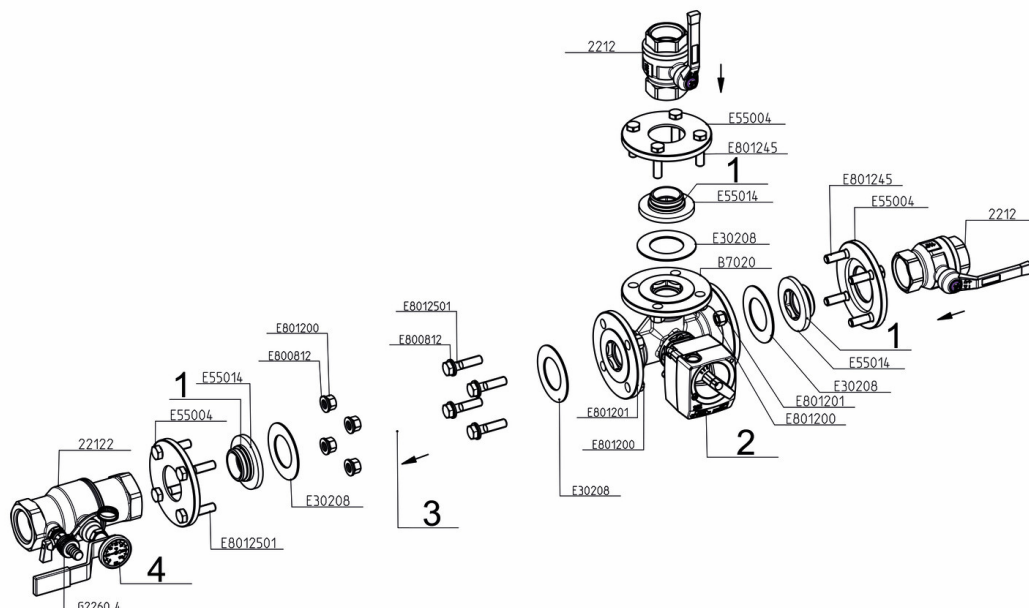
5.4 Pièces de rechange DN 40

Position	Pièce de rechange	N° d'art.
1	Set de joints collecteur DN 40 / 50	N00061
2	Servomoteur 5 Nm, 230 V, 50 Hz	705001
3	Pompe : voir tableau suivant	
4	Thermomètre à cadran, échelle bleue, d = 50 mm, 0 - 120 °C	N00243
sans pos.	Bouton rotatif ac bord d.butée	N00232
sans pos.	Brides de réduction	41610

N° d'art. maintien de la temp. de retour	Pompe	N° d'art. pompe	IEE
960861WY12	Wilo Yonos MAXO plus 40/0.5-12	E12343712	< 0,20
960861GH12	Grundfos Magna3 40-120 F	N00545	< 0,19
960861GL10	Grundfos Magna1 32-100	E1217310	< 0,21
960861GL12	Grundfos Magna1 40-120 F	E121761	< 0,21
960861GU12	Grundfos UPMXXL 32-120	E12144812	< 0,24
960861GX12	Grundfos UPMXL GEO 32-125	E12143812F	0,23

5 Volume de livraison [Expert]

5.5 Pièces de rechange DN 50

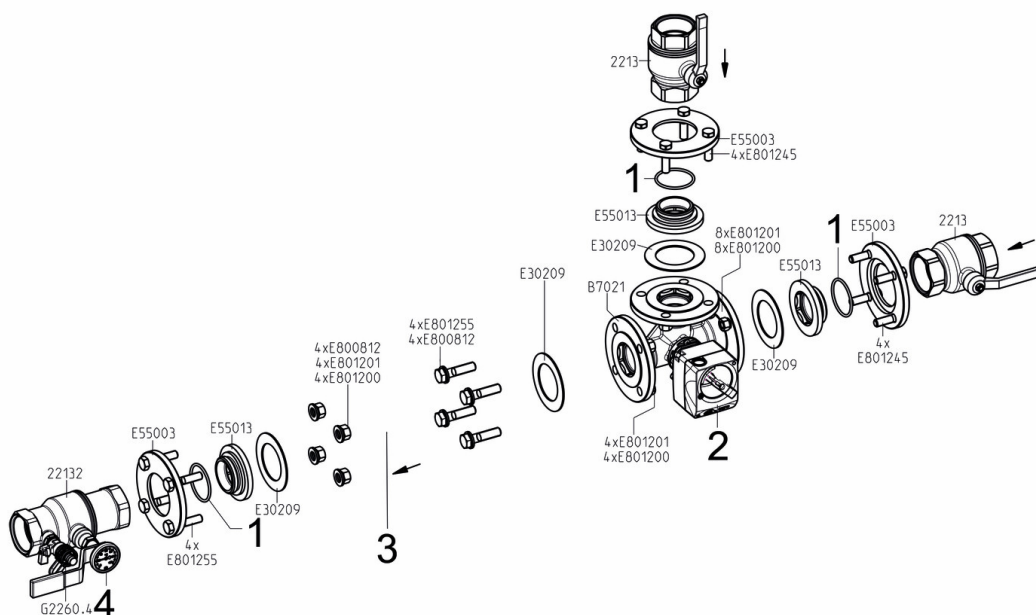

Position	Pièce de rechange	N° d'art.
1	Set de joints collecteur DN 40 / 50	N00061
2	Servomoteur 5 Nm, 230 V, 50 Hz	705001
3	Pompe : voir tableau suivant	
4	Thermomètre à cadran, échelle bleue, d = 50 mm, 0 - 120 °C	N00243
sans pos.	Bouton rotatif ac bord d.butée	N00232
sans pos.	Brides de réduction	5162

N° d'art. maintien de la temp. de retour	Pompe	N° d'art. pompe	IEE
960871WY9	Wilo Yonos MAXO plus 50/0.5-9	E12343809	< 0,21
960871GL10	Grundfos Magna1 32-100	E1217310	< 0,21
960871GL12	Grundfos Magna1 50-120 F	E121781	< 0,21

6 Données techniques

Maintien de la temp. de retour	DN 20	DN 25	DN 32	DN 40	DN 50
Dimensions					
Hauteur d'installation	134 mm	187 mm	217 mm	266 mm	296 mm
Longueur d'installation	359 mm	437 mm	497 mm	735 mm	792 mm
Raccords	Fil. int. ¾"	Fil. int. 1"	Fil. int. 1¼"	Fil. int. 1½"	Fil. int. 2"
Hydraulique					
Pression maximale	6 bars	6 bars	6 bars	6 bars	6 bars
Température maximale	110 °C	110 °C	110 °C	110 °C	110 °C
Valeur K_{VS} [m ³ /h]	5,45	10	16	23	25
Puissance	jusqu'à 19,5 kW	jusqu'à 31 kW	jusqu'à 50 kW	jusqu'à 80 kW	jusqu'à 120 kW
pour $\Delta T = 10$ K	1.650 l/h*	2.670 l/h*	4.310 l/h*	6.890 l/h*	10.340 l/h*
*Respectez la hauteur de refoulement (restante) de la pompe !					
Matériaux					
Robinetteries	Laiton				
Joint	AFM34 / EPDM				

6.1 Courbes caractéristiques de perte de charge et des pompes

DN 20

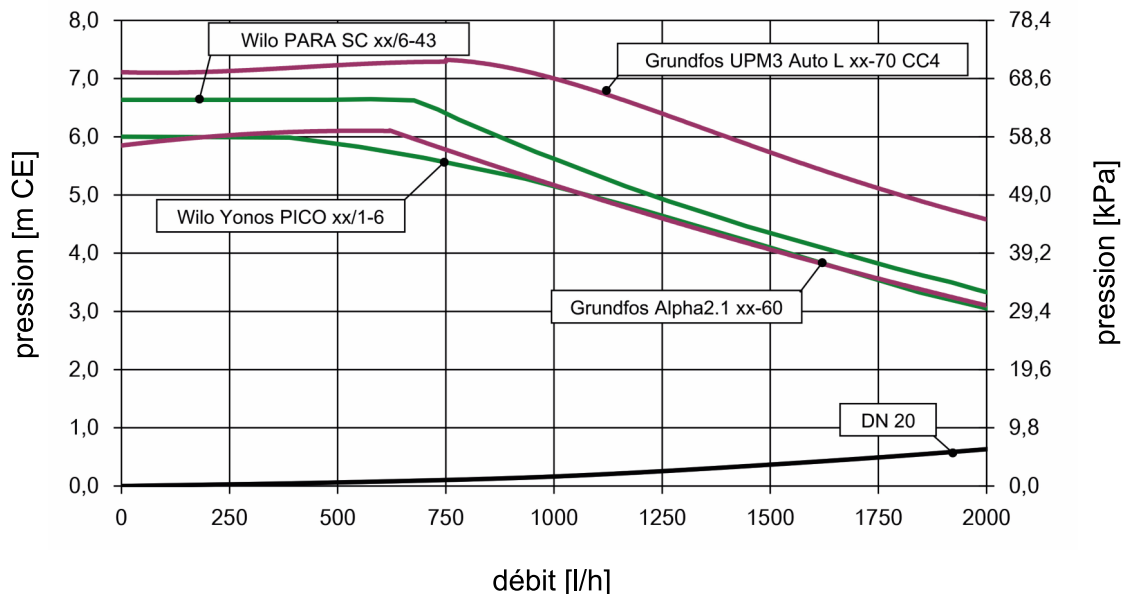

DN 25 + DN 32

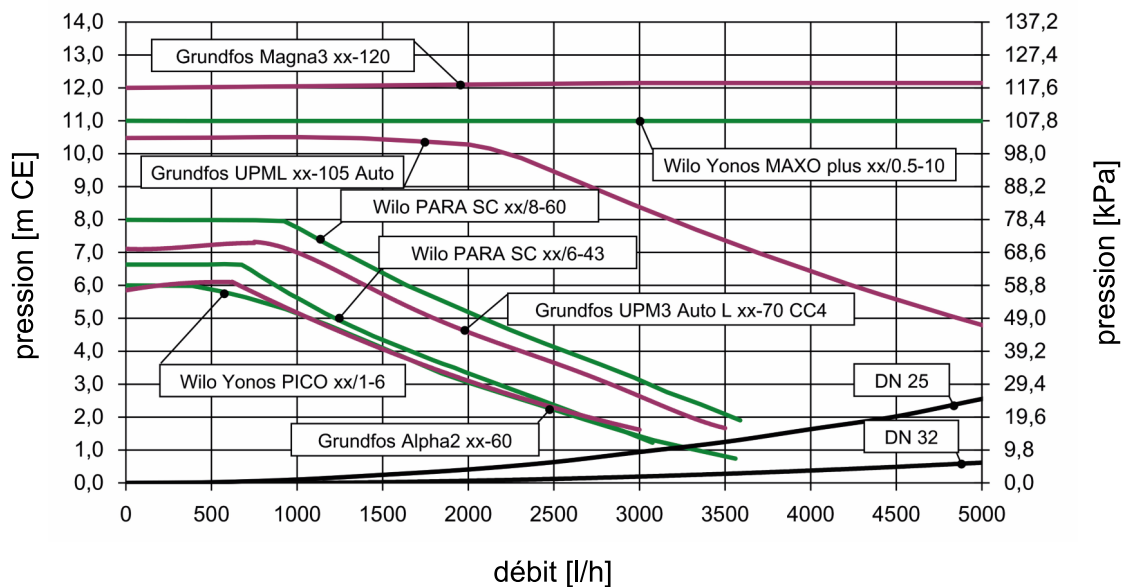

DN 40 + DN 50

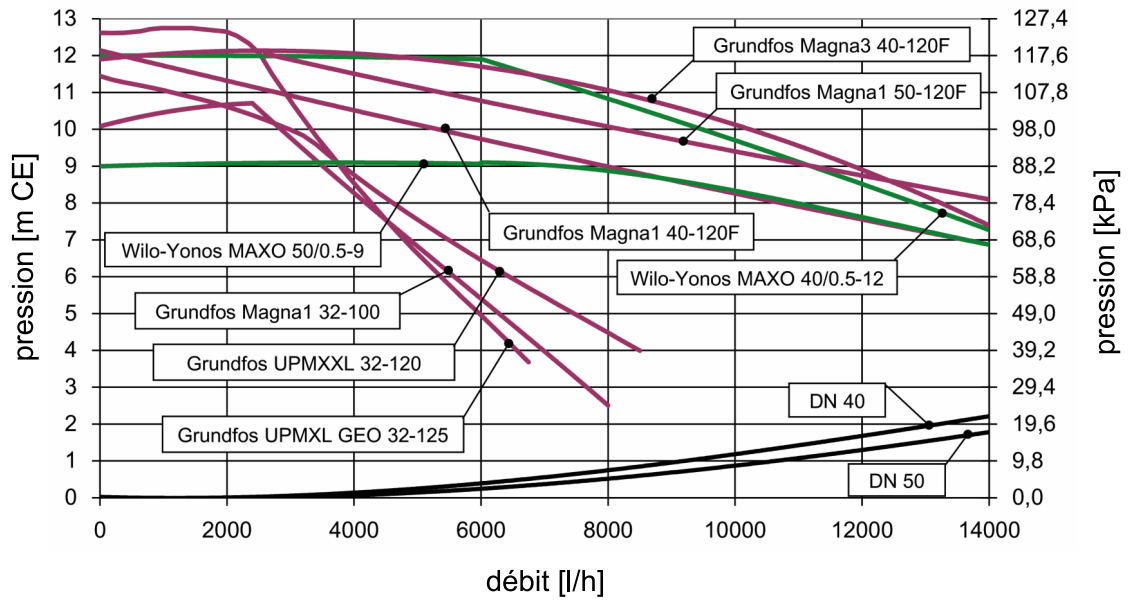

7 Élimination des déchets

AVIS

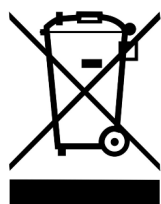

Les équipements électriques et électroniques ne doivent pas être éliminés avec les ordures ménagères.

Pour la restitution de ces appareils, il y a des points de collecte gratuits pour les déchets d'équipements électriques et électroniques dans votre région ainsi qu'éventuellement d'autres points de collecte pour la réutilisation des appareils.

Votre administration municipale ou communale vous communiquera les adresses correspondantes.

Si l'équipement électrique et électronique utilisé contient des données personnelles, vous êtes responsable de leur élimination avant de rendre l'appareil.

Les batteries et accumulateurs doivent être démontés avant le retour du produit.

En fonction de l'équipement du produit (partiellement avec des accessoires optionnels), des composants individuels peuvent également contenir des batteries et des accumulateurs. A cet effet, veuillez observer les symboles d'évacuation sur les composants en question.

Évacuation des matériaux de transport et d'emballage

L'emballage est composé de matières recyclables et peut être réinséré dans le circuit de recyclage.

N° d'art. 999608-mub-ml

Traduction de la notice originale

Sous réserve de modifications techniques !

Printed in Germany - Copyright by PAW GmbH & Co. KG

PAW GmbH & Co. KG

Böcklerstraße 11

31789 Hameln, Allemagne

www.paw.eu

Tél : +49-5151-9856-0

Fax : +49-5151-9856-98



Istruzioni per il montaggio e per l'uso Innalzamento della temperatura di ritorno con servomotore

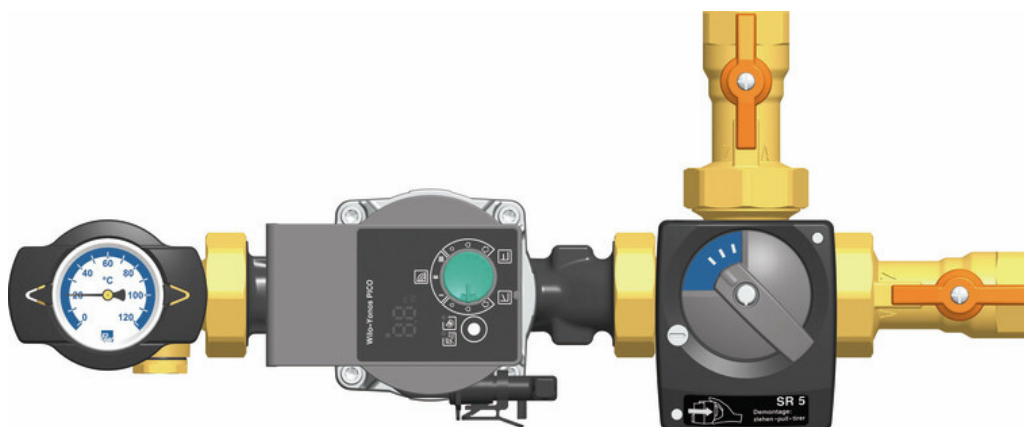

Indice

1	Informazioni generali.....	3
1.1	Campo di applicazione delle istruzioni.....	3
1.2	Uso conforme allo scopo.....	3
2	Avvertenze per la sicurezza.....	4
3	Descrizione del prodotto.....	5
3.1	Dotazione.....	5
3.2	Funzione.....	6
4	Montaggio e installazione [esperto].....	7
4.1	Montaggio del servomotore [esperto].....	7
5	Dotazione [esperto].....	10
5.1	Pezzi di ricambio DN 20.....	11
5.2	Pezzi di ricambio DN 25.....	12
5.3	Pezzi di ricambio DN 32.....	13
5.4	Pezzi di ricambio DN 40.....	14
5.5	Pezzi di ricambio DN 50.....	15
6	Dati tecnici.....	16
6.1	Perdita di pressione e curve caratteristiche della pompa.....	17
7	Smaltimento.....	19

1 Informazioni generali



Leggere attentamente le presenti istruzioni prima dell'installazione e della messa in funzione. Conservare le istruzioni presso l'impianto per una successiva consultazione.

1.1 Campo di applicazione delle istruzioni

Le presenti istruzioni descrivono il funzionamento, l'installazione, la messa in servizio e l'uso del innalzamento della temperatura di ritorno con servomotore DN 20 - DN 50.

Per gli altri componenti dell'impianto, come ad es. la pompa, il regolatore o il servomotore, osservare le istruzioni dei rispettivi costruttori. I capitoli indicati dalla scritta [esperto] si rivolgono esclusivamente agli specialisti del settore.

1.2 Uso conforme allo scopo

Il prodotto può essere utilizzato nei circuiti di riscaldamento solamente in considerazione dei valori tecnici limite indicati nelle presenti istruzioni.

Il prodotto **non** può essere usato per applicazioni con acqua potabile.

L'uso non conforme all'uso previsto comporta l'esclusione di qualsiasi garanzia.

Il prodotto soddisfa le direttive rilevanti ed è quindi dotato della marcatura CE. La dichiarazione di conformità può essere richiesta presso il costruttore.

Collegare al prodotto solamente accessori PAW.

2 Avvertenze per la sicurezza

L'installazione, la messa in funzione nonché l'allacciamento dei componenti elettrici presuppongono conoscenze specialistiche, corrispondenti a un diploma di qualifica professionale riconosciuto, come impiantista termotecnico per impianti sanitari, di riscaldamento e di condizionamento ovvero a una professione con pari livello di conoscenze [esperto].

Durante l'installazione e la messa in servizio deve essere osservato quanto segue:

- normative nazionali e regionali
- norme antinfortunistiche dell'Istituto di assicurazione contro gli infortuni sul lavoro
- indicazioni e avvertenze per la sicurezza delle presenti istruzioni per l'uso



ATTENZIONE



Danni personali e materiali!

Il prodotto è solo adatto per l'impiego in circuiti di riscaldamento con acqua di riscaldamento in conformità con VDI 2035 / Ö-Norm H 5195-1.

- ▶ Il prodotto **non** essere usato per applicazioni con acqua potabile.

NOTA

Danni materiali da oli minerali!

I prodotti con olio minerale danneggiano gli elementi di guarnizione EPDM il che compromette le caratteristiche di tenuta. Non ci assumiamo alcuna responsabilità per danni causati da guarnizioni danneggiate in questo modo né provvediamo alla spedizione di merce a titolo di garanzia.

- ▶ Evitare assolutamente che l'EPDM venga a contatto con sostanze contenenti oli minerali.
- ▶ Utilizzare un lubrificante senza olio minerale a base di silicone o polialchilene, come ad es. Unisilikon L250L e Syntheso Glep 1 della ditta Klüber o spray al silicone.

3 Descrizione del prodotto

Il innalzamento della temperatura di ritorno sono gruppi preassemblati di raccordi per circuiti di riscaldamento. La pompa può essere bloccata tramite le valvole a sfera e può essere mantenuta senza dover scaricare l'acqua dal circuito di riscaldamento.

3.1 Dotazione

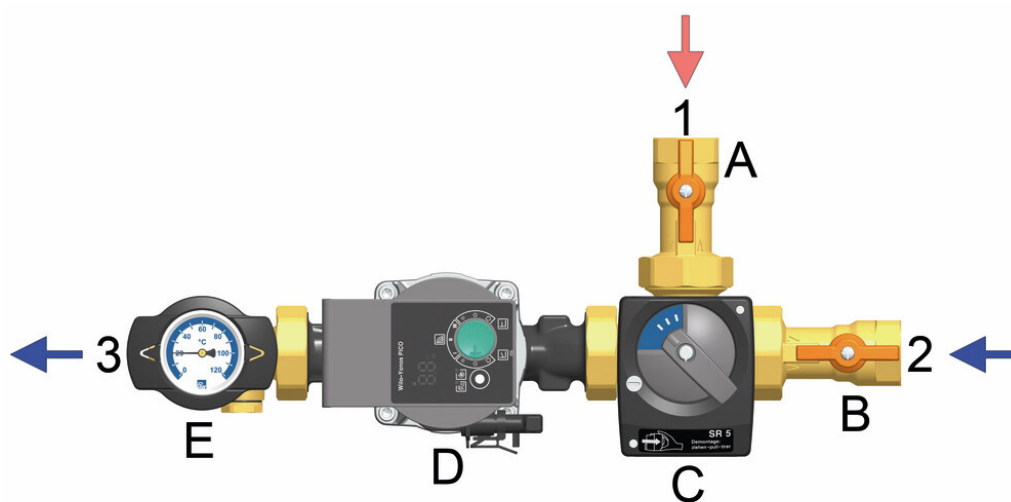

DN 25-50

- 1 Bypass dalla mandata caldaia
- 2 Ritorno dall'accumulatore tampone
- 3 Ritorno alla caldaia
- A Valvola a sfera, bypass dalla mandata caldaia
- B Valvola a sfera, ritorno dall'accumulatore tampone
- C Valvola a 3 vie con servomotore
- D Pompa di riscaldamento
- E Valvola a sfera, ritorno
- F* Innalzamento della temperatura di ritorno DN 25 e DN 32, con isolamento opzionale (a seconda della versione della pompa)



3.2 Funzione

Grazie all'innalzamento della temperatura di ritorno, si evita di scendere sotto il punto di condensazione nonché la formazione di catrame all'interno della caldaia.

Il innalzamento della temperatura di ritorno è montato tra l'accumulatore tampone e la caldaia.

Il servomotore viene comandato da un regolatore esterno. Il servomotore apre la valvola a 3 vie solo nel momento in cui il circuito della caldaia ha raggiunto la temperatura di apertura impostata. Poi la potenza della pompa è disponibile per caricare l'accumulatore.

Campi di impiego:

- per fonti di calore che richiedono un innalzamento temperatura di ritorno, come ad es. caldaie a combustibile solido, impianti a legna o caminetti e termocamini/stufe

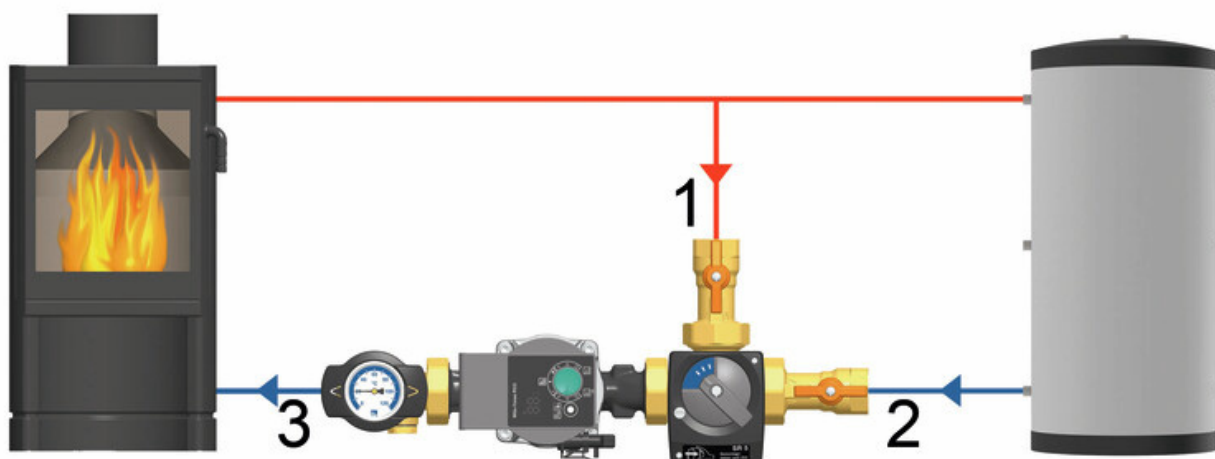

4 Montaggio e installazione [esperto]

NOTA

Danni materiali!

Per il montaggio sicuro dell'impianto, il luogo di montaggio deve essere asciutto, staticamente stabile, nonché protetto da gelate e dalle radiazioni UV. Montare la pompa sempre nel ritorno della caldaia perché si potrebbe danneggiare a causa delle temperature di mandata elevate.

4.1 Montaggio del servomotore [esperto]

Servomotore SR2 / SR5 / SR10

Servomotore SR2

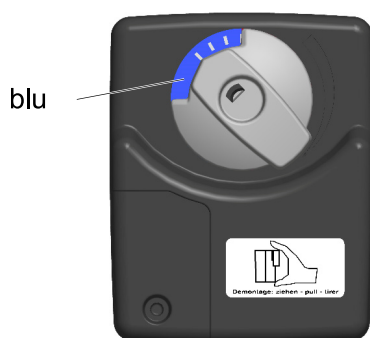

Servomotore SR5 / SR10

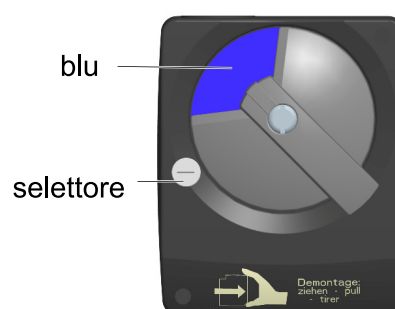

1. Impostare il servomotore su modalità manuale.
SR2: Premere la manopola di regolazione e tenerla premuta.
SR5 / SR10: Ruotare il selettore di 90° con un cacciavite.
2. Ruotare la manopola di regolazione a sinistra in posizione "blu".
3. Ruotare la manopola della valvola a 3 vie in modo che l'aletta sia rivolta verso il basso o verso sinistra ↔.

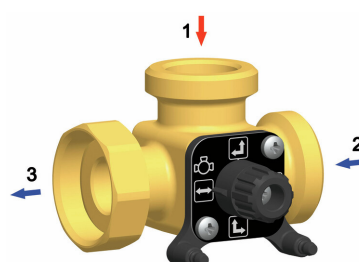
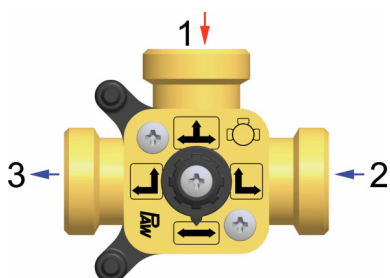



4. Ruotare il servomotore come mostrato e farlo scattare sulla valvola a 3 vie.
5. Collegare il servomotore al regolatore.
6. SR2: Il servomotore torna automaticamente in modalità automatica.

SR5 / SR10: Ruotare il selettore sul servomotore di 90° con un cacciavite. Il servomotore è ora in modalità automatica.

Il servomotore è ora pronto per il funzionamento.

Se il motore è attivato, gira 90° in direzione orario!

Servomotore SR2 - DN 20

100 % ritorno



Posizione "blu"

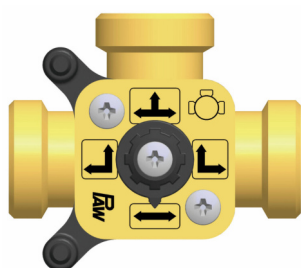

Aletta in posizione ↔

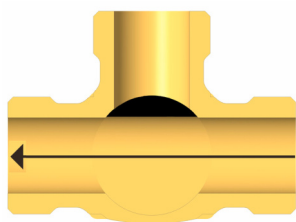

100% di mandata caldaia



Posizione "rosso"

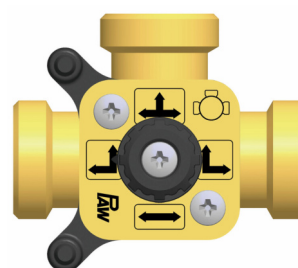

Aletta in posizione ↗

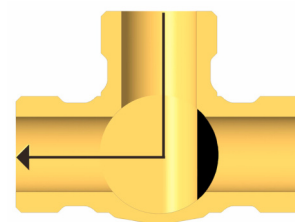

Servomotore SR5 - DN 25 + DN 32 + DN 40 / SR10 - DN 40 + DN 50

100 % ritorno



Posizione "blu"

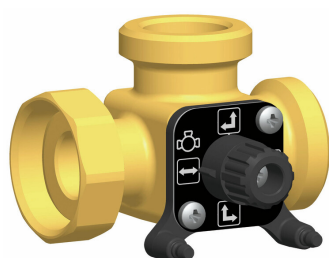

Aletta in posizione ↔

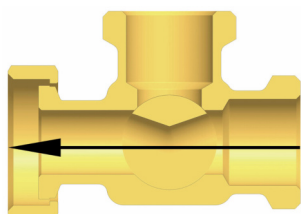

100% di mandata caldaia



Posizione "rosso"

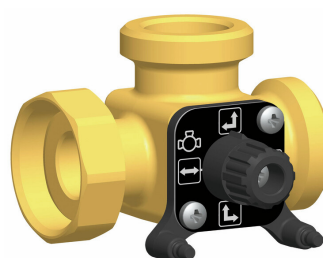

Aletta in posizione ↕

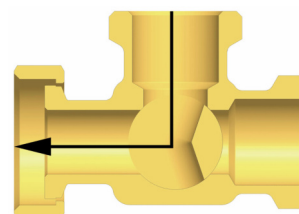

5 Dotazione [esperto]

NOTA

Numero di serie

Reclami e richieste/ordini di ricambi vengono elaborati esclusivamente se riportano l'indicazione del numero di serie! Il numero di serie si trova sul tubo di ritorno del prodotto.

5 Dotazione [esperto]

5.1 Pezzi di ricambio DN 20

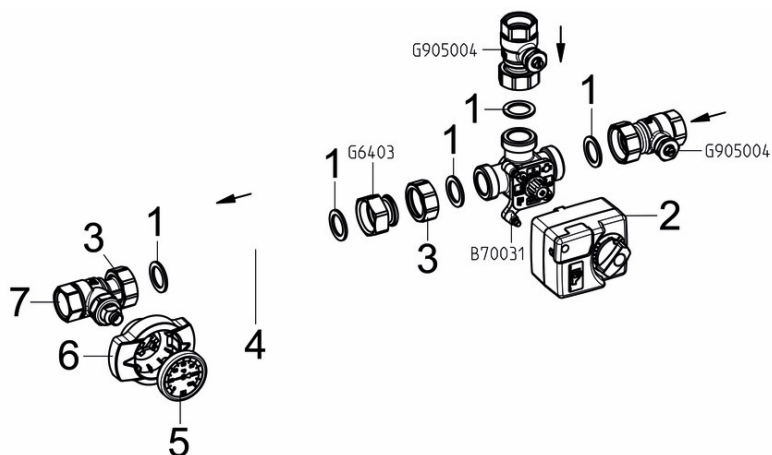

Pos.	Pezzo di ricambio	Cod. art.
1	Guarnizione ½", per raccordo 1"	N00024
2	Servomotore SR2, 230 V AC, 2 Nm, 105 s / 90°	N00070
3	Dado per raccordo G 1"	N00302
4	Pompa: vedi seguente tabella	
5	Termometro a quadrante, scala di colore blu, d=50 mm, 0 - 120 °C	N00243
6	Maniglia termometro per valvola portatermometro 1"	N00248
7	Valv. portaterm. DN 20, F ½" x ¾" fil. femm.	N00202

Cod. art. innalzamento della temp. di ritorno	Pompa	Cod. art. pompa	IEE
96083WP6	Wilo Para SC 15/6-43	N00258	< 0,20
96083WN06	Wilo Yonos PICO 15/1-6	N00315	< 0,20
96083GM6	Grundfos UPM3 Auto L 15-70	N00333	< 0,20
96083GH6	Grundfos Alpha2.1 15-60	N00336	< 0,17

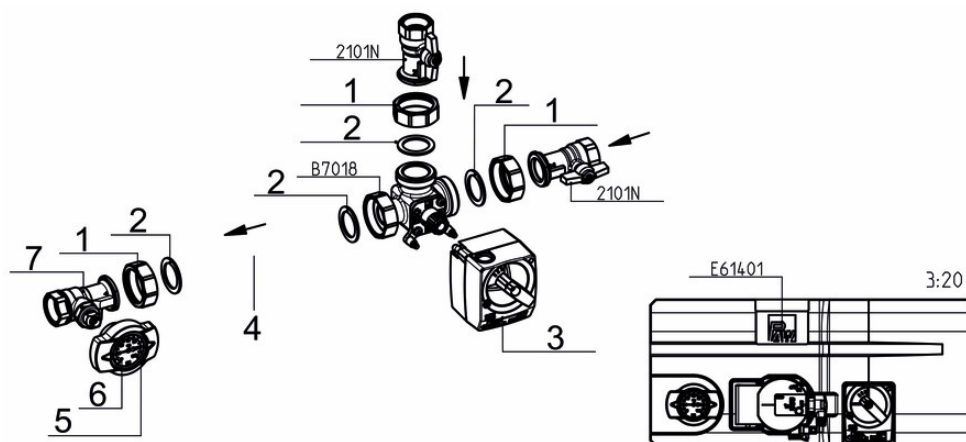
5.2 Pezzi di ricambio DN 25

Pos.	Pezzo di ricambio	Cod. art.
1	Dado per raccordo G 1½"	N00269
2	Guarnizione 1", per raccordo 1½"	N00036
3	Servomotore 5 Nm, 230 V, 50 Hz	705001
4	Pompa: vedi seguente tabella	
5	Maniglia termometro per valvola a sfera termica 1"	N00248
6	Termometro a quadrante, scala di colore blu, d=50 mm, 0-120 °C	N00243
7	Valv. portaterm. TK DN 25, F1" x 1" fil. femm., ½" manicotto a sinistra	N00013
s. pos.	Manopola con bordo di arresto	N00232

Cod. art. Innalzamento della temp. di ritorno	Pompa	Cod. art. pompa	IEE
960841WP6	Wilo Para SC 25/6-43	N00259	< 0,20
960841WP8	Wilo Para SC 25/8-60	N00271	< 0,21
960841WN06	Wilo Yonos PICO 25/1-6	N00214	< 0,20
960841GM6	Grundfos UPM3 Auto L 25-70	N00237	< 0,20
960841GH6	Grundfos Alpha2.1 25-60	N00236	< 0,17
960841GL9	Grundfos UPML 25-105 AUTO	N00396	< 0,23

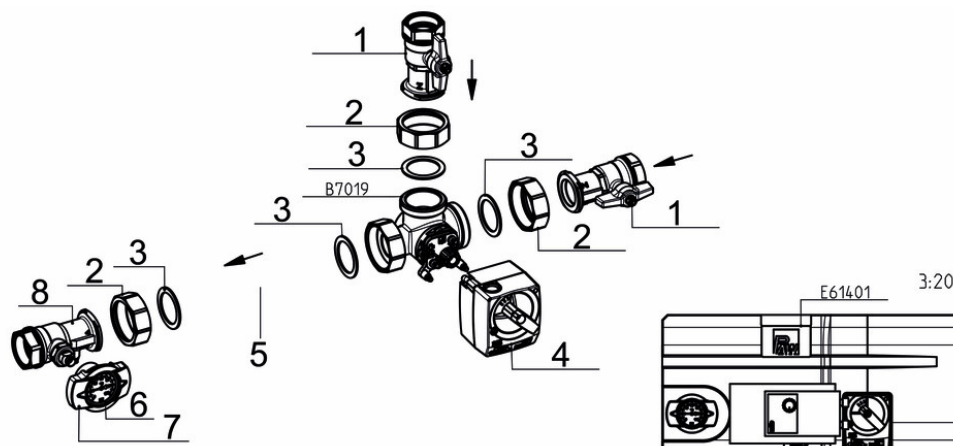
5.3 Pezzi di ricambio DN 32

Pos.	Pezzo di ricambio	Cod. art.
1	Valv. per pompe PK 1¼", F 1¼" x G 1¼"	2102
2	Dado per raccordo G 2"	N00270
3	Guarnizione 1¼", per raccordo 2"	N00047
4	Servomotore 5 Nm, 230 V, 50 Hz	705001
5	Pompa: vedi seguente tabella	
6	Termometro a quadrante, scala di colore blu, d=50 mm, 0-120 °C	N00243
7	Maniglia termometro per valvola a sfera termica 1"	N00248
8	Valv. portaterm. TK DN 32, F1¼" x 1¼" fil. femm. manicotto a sinistra	N00446
s. pos.	Manopola con bordo di arresto	N00232

Cod. art. innalzamento della temp. di ritorno	Pompa	Cod. art. pompa	IEE
960851WN06	Wilo Yonos PICO 30/1-6	N00313	< 0,20
960851WP6	Wilo Para SC 30/6-43	N00261	< 0,20
960851WY10	Wilo Yonos MAXO plus 30/0.5-10	N00398	< 0,20
960851GM6	Grundfos UPM3 Auto L 32-70	N00240	< 0,20
960851GH6	Grundfos Alpha2.1 32-60	N00239	< 0,17
960851GH12	Grundfos Magna3 32-120	N00540	0,19
960851GL9	Grundfos UPML 32-105 AUTO	N00344	< 0,24

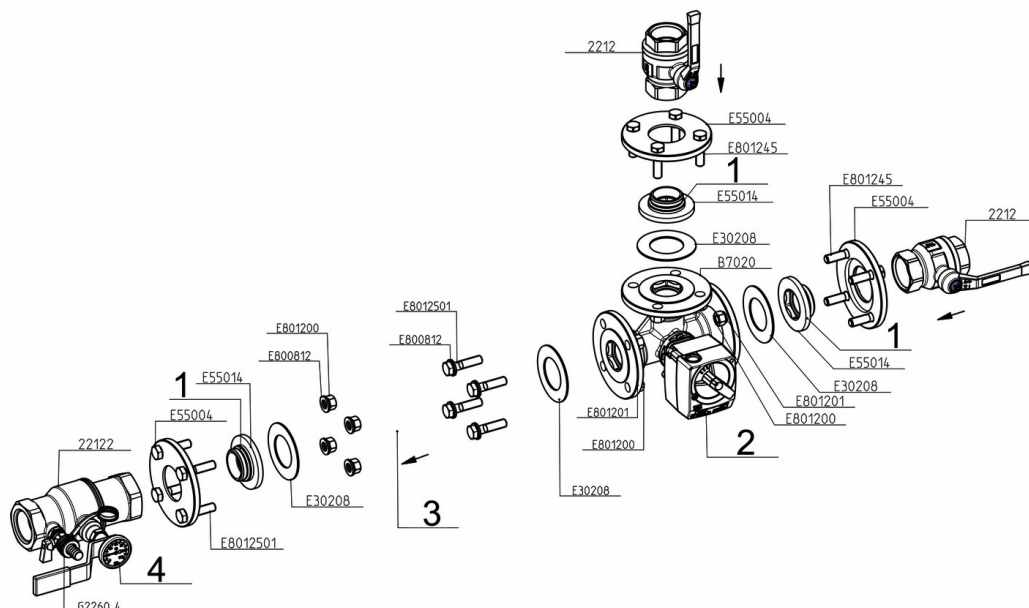
5.4 Pezzi di ricambio DN 40

Pos.	Pezzo di ricambio	Cod. art.
1	Set di guarnizioni per collettore DN 40 / DN 50	N00061
2	Servomotore 5 Nm, 230 V, 50 Hz	705001
3	Pompa: vedi seguente tabella	
4	Termometro a quadrante, scala di colore blu, d=50 mm, 0 - 120 °C	N00243
s. pos.	Manopola con bordo di arresto	N00232
s. pos.	Flangie di riduzione	41610

Cod. art. innalzamento della temp. di ritorno	Pompa	Cod. art. pompa	IEE
960861WY12	Wilo Yonos MAXO plus 40/0.5-12	E12343712	< 0,20
960861GH12	Grundfos Magna3 40-120F	N00545	< 0,19
960861GL10	Grundfos Magna1 32-100	E1217310	< 0,21
960861GL12	Grundfos Magna1 40-120F	E121761	< 0,21
960861GU12	Grundfos UPMXXL 32-120	E12144812	< 0,24
960861GX12	Grundfos UPMXL GEO 32-125	E12143812F	0,23

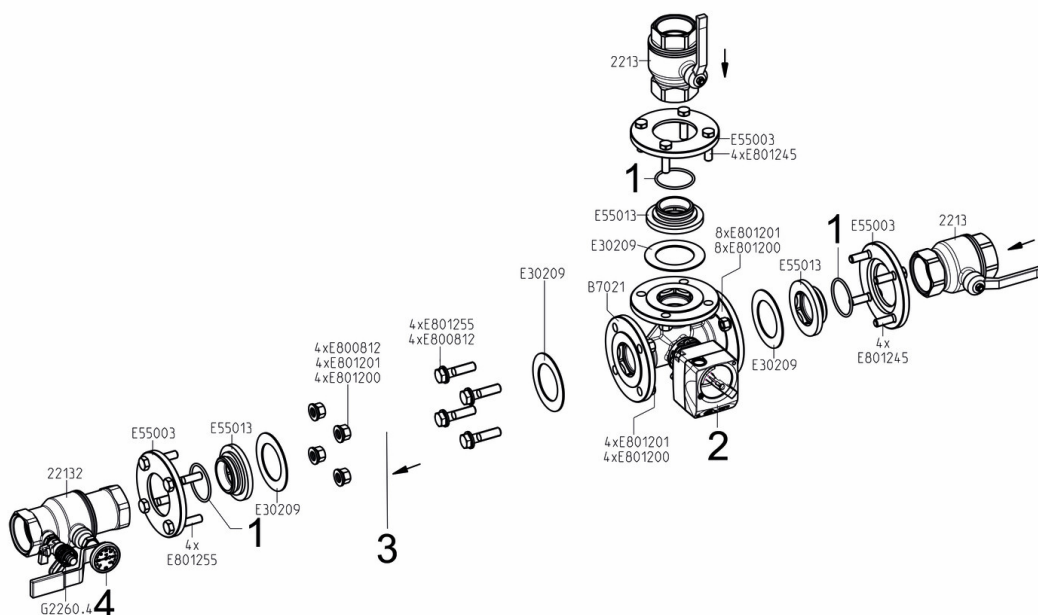
5.5 Pezzi di ricambio DN 50

Pos.	Pezzo di ricambio	Cod. art.
1	Set di guarnizioni per collettore DN 40 / DN 50	N00061
2	Servomotore 5 Nm, 230 V, 50 Hz	705001
3	Pompa: vedi seguente tabella	
4	Termometro a quadrante, scala di colore blu, d=50 mm, 0 - 120 °C	N00243
s. pos.	Manopola con bordo di arresto	N00232
s. pos.	Flangie di riduzione	5162

Cod. art. innalzamento della temp. di ritorno	Pompa	Cod. art. pompa	IEE
960871WY9	Wilos Yonos MAXO plus 50/0.5-9	E12343809	< 0,21
960871GL10	Grundfos Magna1 32-100	E1217310	< 0,21
960871GL12	Grundfos Magna1 50-120 F	E121781	< 0,21

6 Dati tecnici

Innalzamento della temp. di ritorno	DN 20	DN 25	DN 32	DN 40	DN 50
Dimensioni					
Altezza di montaggio	134 mm	187 mm	217 mm	266 mm	296 mm
Lunghezza di ingombro	359 mm	437 mm	497 mm	735 mm	792 mm
Attacchi	¾" fil. femm.	1" fil. femm.	1¼" fil. femm.	1½" fil. femm.	2" fil. femm.
Idraulica					
Pressione max.	6 bar	6 bar	6 bar	6 bar	6 bar
Temperatura max.	110 °C	110 °C	110 °C	110 °C	110 °C
Valore K_{VS} [m³/h]	5,45	10	16	23	25
Potenza	fino a 19,5 kW	fino a 31 kW	fino a 50 kW	fino a 80 kW	fino a 120 kW
con $\Delta T = 10 K$	1.650 l/h*	2.670 l/h*	4.310 l/h*	6.890 l/h*	10.340 l/h*
*Osservare la prevalenza della pompa o la prevalenza residual!					
Materiali					
Raccorderia	Ottone				
Guarnizioni	AFM34 / EPDM				

6.1 Perdita di pressione e curve caratteristiche della pompa

DN 20

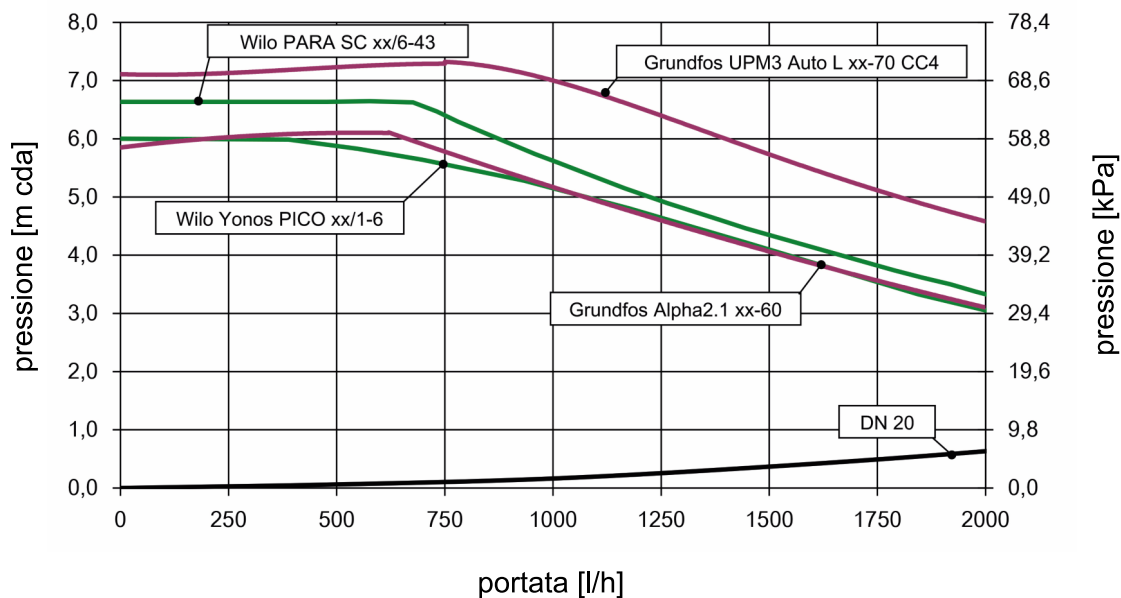

DN 25 + DN 32

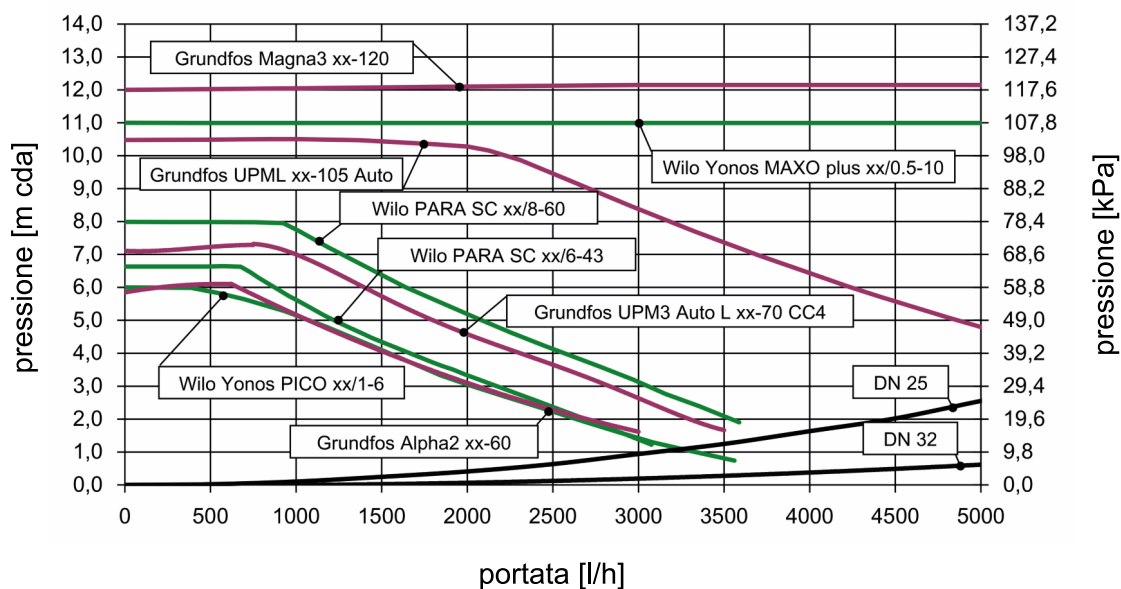

DN 40 + DN 50

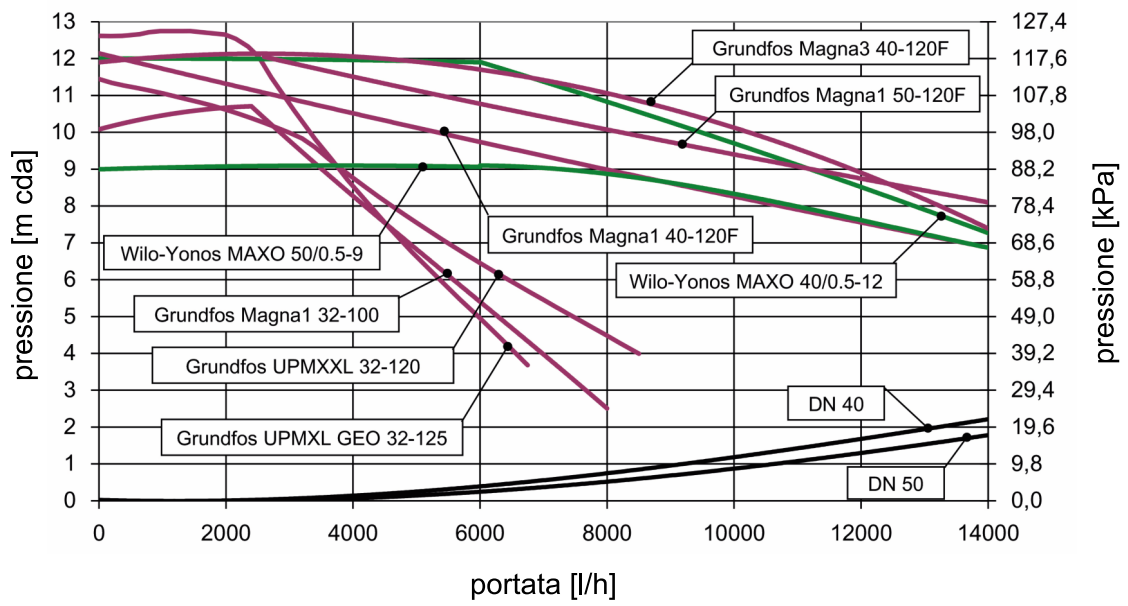

7 Smaltimento

NOTA

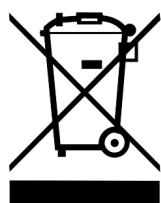

Gli apparecchi elettrici ed elettronici non possono essere smaltiti insieme ai rifiuti domestici.

Per il ritiro dei rifiuti di apparecchi elettrici sono disponibili nella sua zona punti di raccolta gratuiti, nonché altri punti di accettazione per il riutilizzo dei dispositivi.

Gli indirizzi si possono ottenere in comune.

Se l'apparecchio elettrico o elettronico dovesse contenere dati personali, l'utente è responsabile della sua eliminazione, prima della sua restituzione.

Prima dello smaltimento devono essere rimosse pile e batterie. A seconda della configurazione del prodotto (con accessori opzionali) anche i singoli componenti possono contenere pile e batterie. Si prega di considerare i simboli di smaltimento riportati sui componenti.

Smaltimento di materiale di trasporto e imballaggio

I materiali d'imballo sono riciclabili e possono essere di nuovo impiegati nel normale ciclo di produzione di materie prime.

Cod. art. 999608-mub-ml

Traduzione delle istruzioni originali

Con riserva di modifiche tecniche.

Printed in Germany - Copyright by PAW GmbH & Co. KG

PAW GmbH & Co. KG

Böcklerstraße 11

31789 Hameln, Germania

www.paw.eu

Tel: +49-5151-9856-0

Fax: +49-5151-9856-98